



[www.seasoned.pk](http://www.seasoned.pk)



 **SEASONED**  
*Take away the Beauty*  
Since 1985

Manufacturers and Exporters of Fine Quality  
Dental Instruments,

DENTAL  
INSTRUMENTS  
CATALOGUE



## TABLE OF CONTENTS

01	Tooth Extraction Forceps	01-49
02	Root Elevators	50-70
03	Scalpel Handles, Handles, Mouth Mirrors Scalers, Explorer / Probes	71-85
04	Endodontic Condensers, Obturation Instruments Excavators, Explorer / Probes, Curette Sets	86-96
05	Amalgam Pluggers / Condensers, Burnishers	97-100
06	Wax Carvers, Carvers, Chisels	101-103
07	Compsite Placement, Plastic Filling Instruments	104-107
08	Curettes, Gracey Curettes, Dental Products, Knives	108-117

---

---



## TABLE OF CONTENTS

09	Wax Porcelain & Cement Instruments Wax & Modelling Instruments	118-121
10	Spatulas, Cement Spatulas	122-124
11	Files, Hoes, Knives, Wax & Plaster Knives, Crane Kaplan	125-128
12	Bone Curettes, Bone Files, Bone Chisels, Bone Mallets	129-133
13	Crown Removers, Crown Instruments	134-136
14	Implant & Measuring Instruments, Suction Tubes, Bone Gauges	137-144
15	Amalgam Guns & Carriers, Retainers, Bands, Strip Holders, Napkin Holders	145-146
16	Rubber Dam Instruments, Rubber Dam Clamps	147-148

---

---

## TABLE OF CONTENTS

17	Syringes, Tweezers, Sterilizing & Lab Instruments	149-156
18	Endodontic Forceps, Tissue Forceps, Haemostatic Forceps, Towel Clamps	157-159
19	Retractors, Lip & Cheek Retractors, Hooks, Depressors & Mouth Gags, Sterilizing Forceps	160-164
20	Orthodontic Pliers & Cutters, Rongeurs	165-179
21	Needle Holders, Scissors, Micro Surgery Set	180-186
22	Impression Trays	187-193
23	Articulators, Hollow Ware	194-200
24	Scissors, Dissecting Forceps, Needle Holders, Wire Cutting Pliers With Tungsten Carbide Inserts	201-213

---

---

# SECTION 01

**SEASONED**  
*Take away the Beauty*  
Since 1985

- ▶ Extraction Forceps
- ▶ Root Elevators



## Extraction Forceps "English Pattern"



**1001**  
Fig. 4  
lower incisor



**1001**  
Fig. 4  
lower incisor



**1002**  
Fig. 8  
lower premolar



**1002**  
Fig. 8  
lower premolars



## Extraction Forceps "English Pattern"



**1003**  
 Fig. 1  
 upper centrals & canines

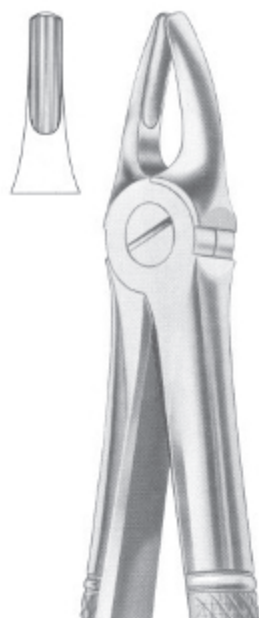

**1004**  
 Fig. 2  
 upper laterals & canines



**1005**  
 Fig. 3  
 upper incisors & canines



**1006**  
 Fig. 4  
 upper incisors & canines



**1007**  
 Fig. 7  
 upper premolars

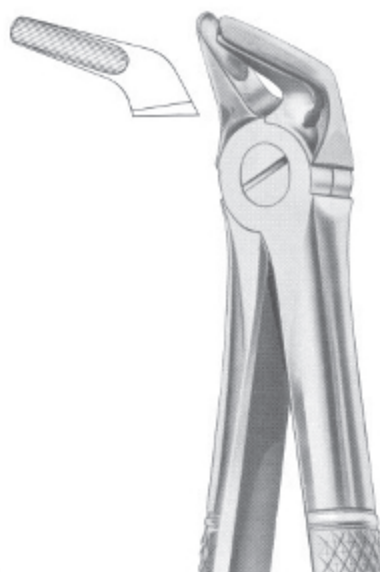

**1008**  
 Fig. 8  
 lower premolars



**1009**  
 Fig. 13  
 lower premolars



## Extraction Forceps "English Pattern"



**1010**  
 Fig. 13S  
 lower premolars  
 for children.

**1011**  
 Fig. 17  
 upper molars, right

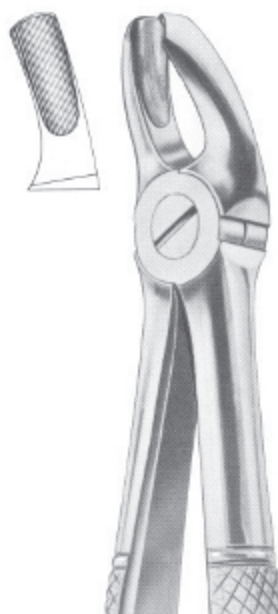

**1012**  
 Fig. 18  
 upper molars, left

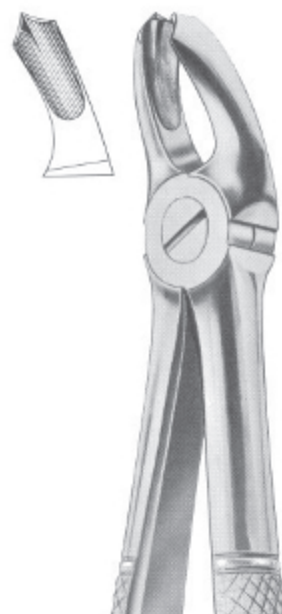

**1013**  
 Fig. 18A  
 upper molars

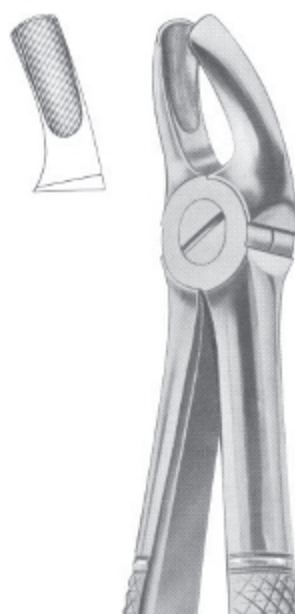

**1014**  
 Fig. 18B  
 upper molars



**1015**  
 Fig. 19  
 upper third molars

**Extraction Forceps "English Pattern"**



**1016**  
 Fig. 20  
 upper third molars

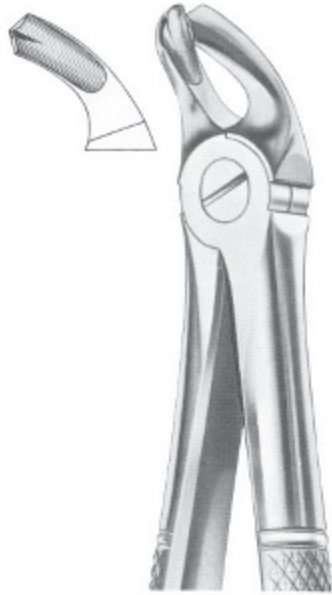

**1017**  
 Fig. 21  
 lower molars

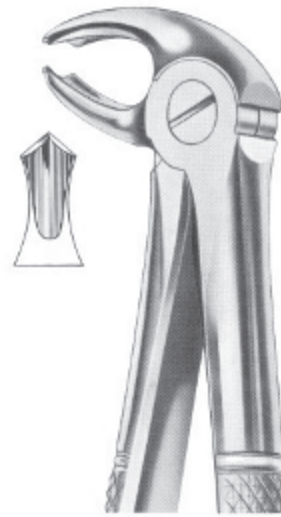

**1018**  
 Fig. 22  
 lower molars



**1019**  
 Fig. 22S  
 lower molars  
 for children

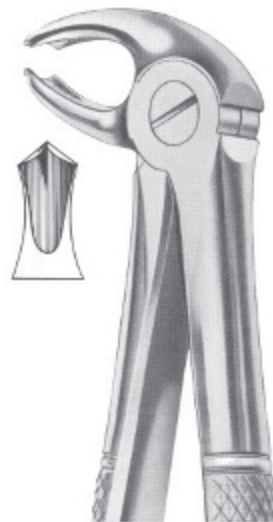

**1020**  
 Fig. 22G  
 lower molars



**1021**  
 Fig. 23  
 lower molars right

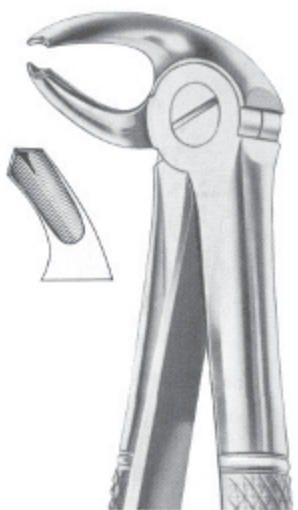

**1022**  
 Fig. 24  
 lower molars left

**Extraction Forceps "English Pattern"**



**1023**  
 Fig. 29  
 upper roots



**1024**  
 Fig. 29S  
 upper roots for children



**1025**  
 Fig. 30  
 upper roots



**1028**  
 Fig. 30S  
 upper roots for children

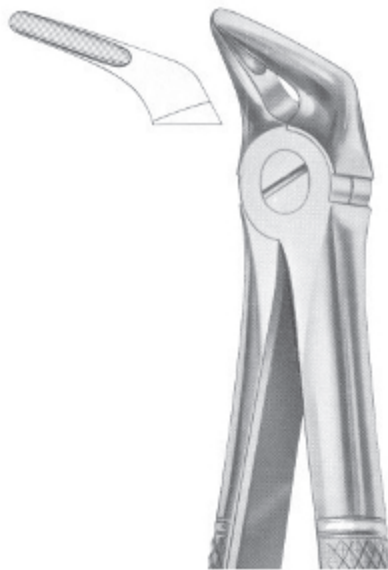

**1026**  
 Fig. 31  
 lower roots

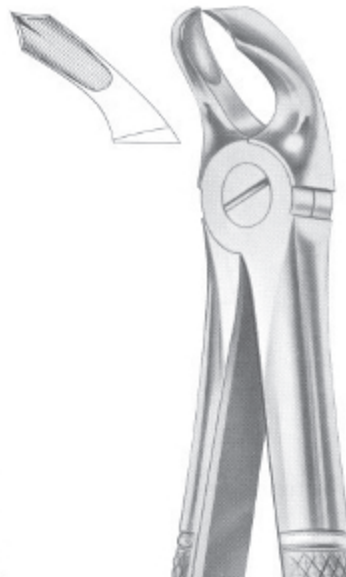

**1027**  
 Fig. 32  
 lower molars



**Extraction Forceps "English Pattern"**

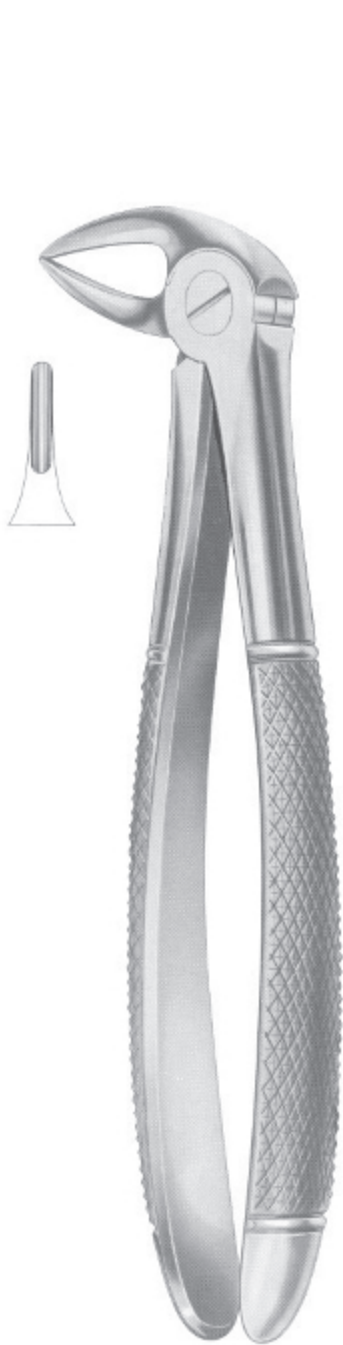

**1029**  
 Fig. 33  
 lower roots

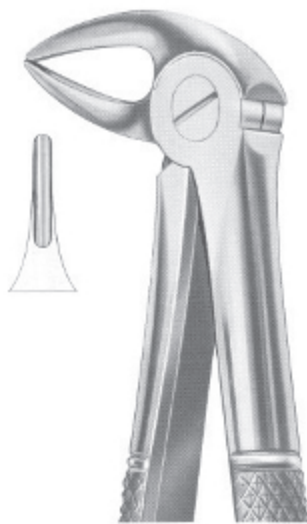

**1030**  
 Fig. 33A  
 lower roots



**1031**  
 Fig. 33B  
 lower roots

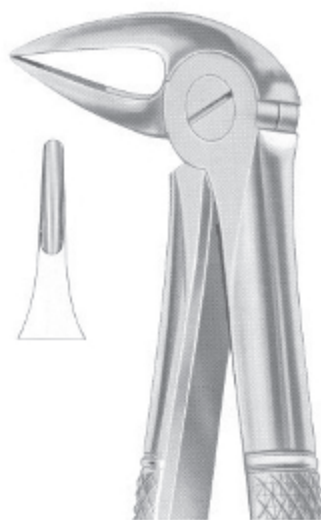

**1032**  
 Fig. 33L  
 lower roots



**1033**  
 Fig. 37  
 upper incisors  
 for children



**1034**  
 Fig. 33S  
 lower roots  
 for children

**Extraction Forceps "English Pattern"**



**1035**  
 Fig. 38  
 lower incisors &  
 canines for children



**1036**  
 Fig. 39  
 upper molars  
 for children



**1037**  
 Fig. 39R  
 upper molars right  
 for children



**1040**  
 Fig. 39L  
 upper molars left  
 for children



**1038**  
 Fig. 39A  
 upper molars  
 for children



**1039**  
 Fig. 40  
 lower molars  
 for children



**Extraction Forceps "English Pattern"**



**1041**  
 Fig. 41  
 upper roots



**1042**  
 Fig. 44  
 upper roots



**1043**  
 Fig. 45  
 lower roots



**1046**  
 Fig. 50  
 upper roots



**1044**  
 Fig. 48  
 lower roots



**1045**  
 Fig. 49  
 upper roots

**Extraction Forceps "English Pattern"**

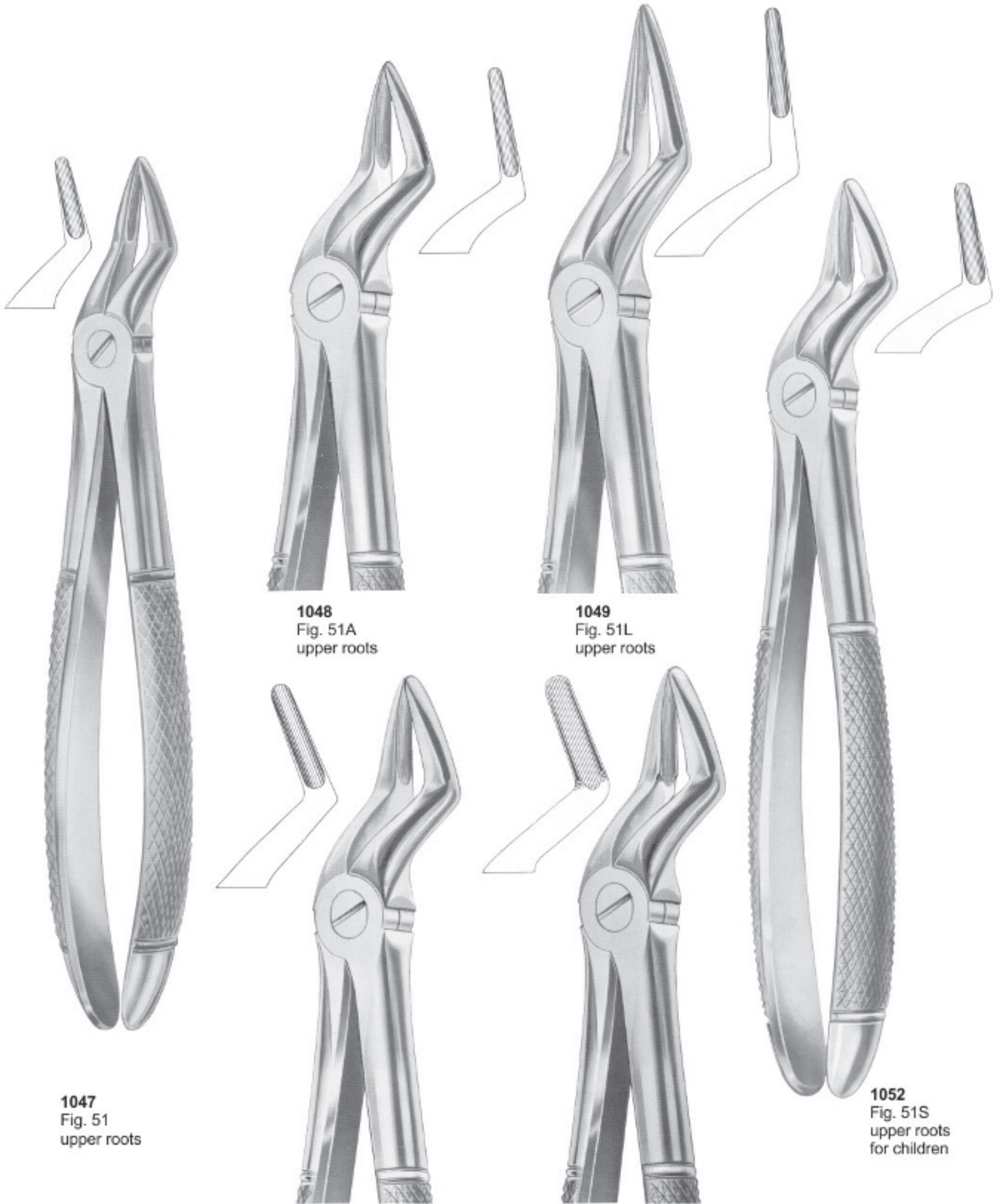

**1047**  
 Fig. 51  
 upper roots

**1048**  
 Fig. 51A  
 upper roots

**1049**  
 Fig. 51L  
 upper roots

**1050**  
 Fig. 52  
 upper roots

**1051**  
 Fig. 52A  
 upper teeth  
 and resection

**1052**  
 Fig. 51S  
 upper roots  
 for children

**Extraction Forceps "English Pattern"**



**1053**  
 Fig. 54  
 for separating  
 upper molars



**1054**  
 Fig. 55  
 for separating  
 upper molars



**1055**  
 Fig. 56  
 for separating  
 lower molars

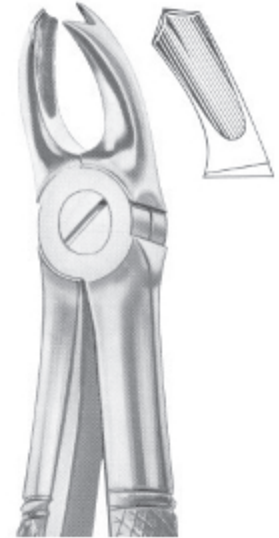

**1056**  
 Fig. 65R  
 upper molars  
 right

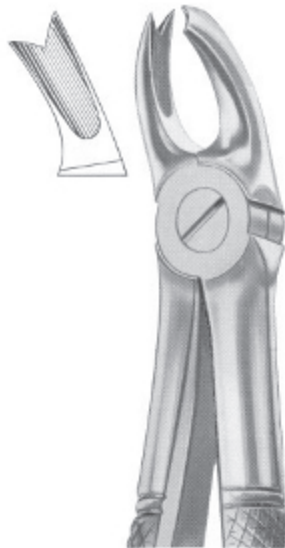

**1057**  
 Fig. 65L  
 upper molars left



**1058**  
 Fig. 67  
 upper third molars

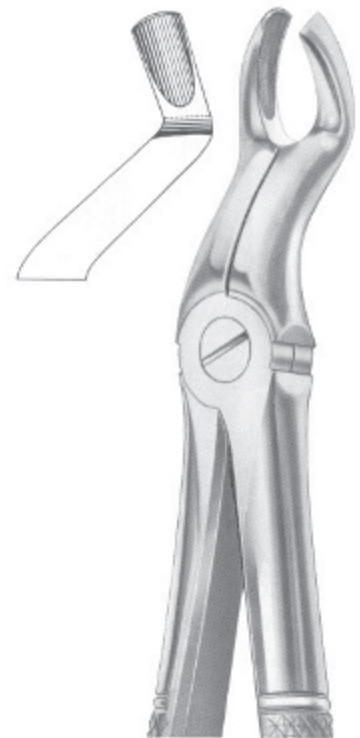

**1059**  
 Fig. 67A  
 upper third molars



**Extraction Forceps "English Pattern"**



**1060**  
 Fig. 67 ½R  
 upper third molars  
 right

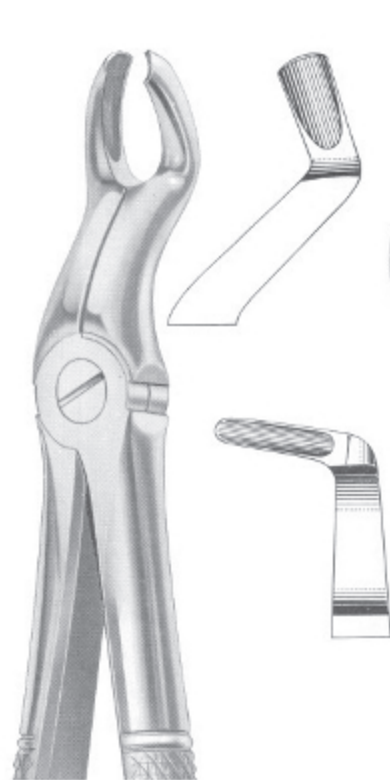

**1061**  
 Fig. 67 ½L  
 upper third molars  
 left



**1062**  
 Fig. 68  
 lower roots

**1063**  
 Fig. 68A  
 lower roots



**1064**  
 Fig. 73  
 lower molars



**1065**  
 Fig. 73R  
 lower molars right



**1066**  
 Fig. 73L  
 lower molars left

**Extraction Forceps "English Pattern"**



**1067**  
 Fig. 73A  
 lower molars



**1068**  
 Fig. 73S  
 lower molars



**1069**  
 Fig. 73B  
 lower molars for children



**1072**  
 Fig. 73K  
 lower molars  
 for children



**1070**  
 Fig. 74  
 lower roots



**1071**  
 Fig. 74D  
 lower roots



**Extraction Forceps "English Pattern"**



**1073**  
 Fig. 74M  
 lower roots



**1074**  
 Fig. 74N  
 lower roots

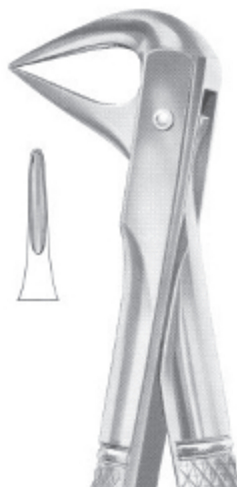

**1075**  
 Fig. 74XN  
 lower roots and  
 crowded incisors



**1078**  
 Fig. 76N  
 upper roots



**1076**  
 Fig. 75  
 lower premolars



**1077**  
 Fig. 76  
 upper roots

## Extraction Forceps "English Pattern"



**1079**  
Fig. 76S  
upper roots



**1080**  
Fig. 79  
lower third molars



**1081**  
Fig. 79A  
lower third molars



**1082**  
Fig. 81  
lower premolars  
and roots

**Extraction Forceps "English Pattern"**



**1083**  
 Fig. 86A  
 lower molars



**1084**  
 Fig. 86B  
 lower molars



**1085**  
 Fig. 86C  
 lower molars



**1086**  
 Fig. 87  
 lower molars



**1087**  
 Fig. 91  
 for separating  
 lower molars



**1088**  
 Fig. 99  
 lower molars

**Extraction Forceps "English Pattern"**



**1089**  
Fig. 101  
upper premolars  
and roots

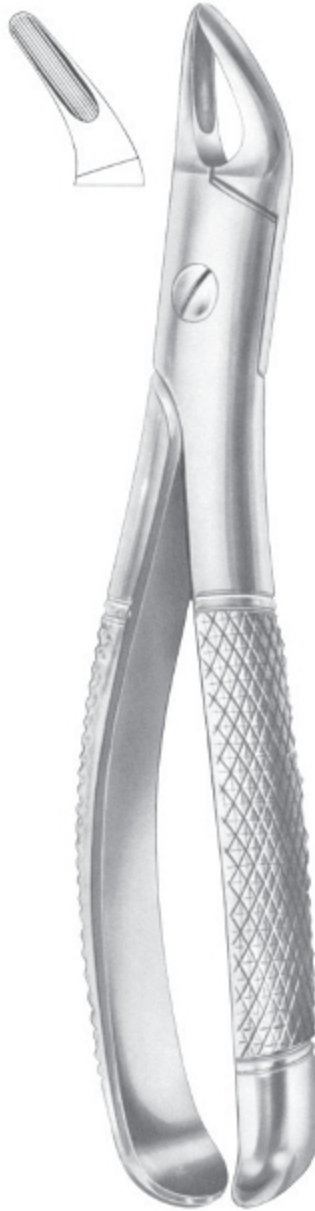

**1090**  
Fig. 100  
upper roots



**1091**  
Fig. 99 1/4  
lower molars



**1092**  
Fig. 99 1/2  
lower molars



**Extraction Forceps "English Pattern"**



**1093**  
 Fig. 102  
 upper molars right



**1094**  
 Fig. 103  
 upper molars left



**1095**  
 Fig. 105  
 lower incisors



**1096**  
 Fig. 106  
 lower incisors



**1097**  
 Fig. 103  
 upper canines



**Extraction Forceps "English Pattern"**



**1098**  
 Fig. 112  
 upper roots

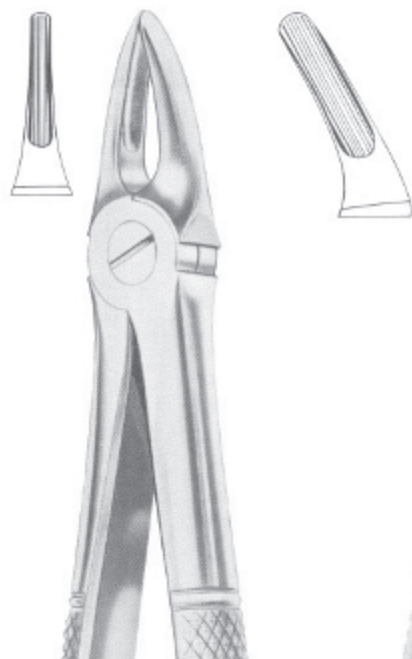

**1099**  
 Fig. 113  
 upper roots



**1101**  
 Fig. 136  
 upper premolars  
 and roots



**1102**  
 Fig. 137  
 lower incisors  
 and roots



**1100**  
 Fig. 114  
 upper roots



**1103**  
 Fig. 143  
 lower roots

**Extraction Forceps "English Pattern"**

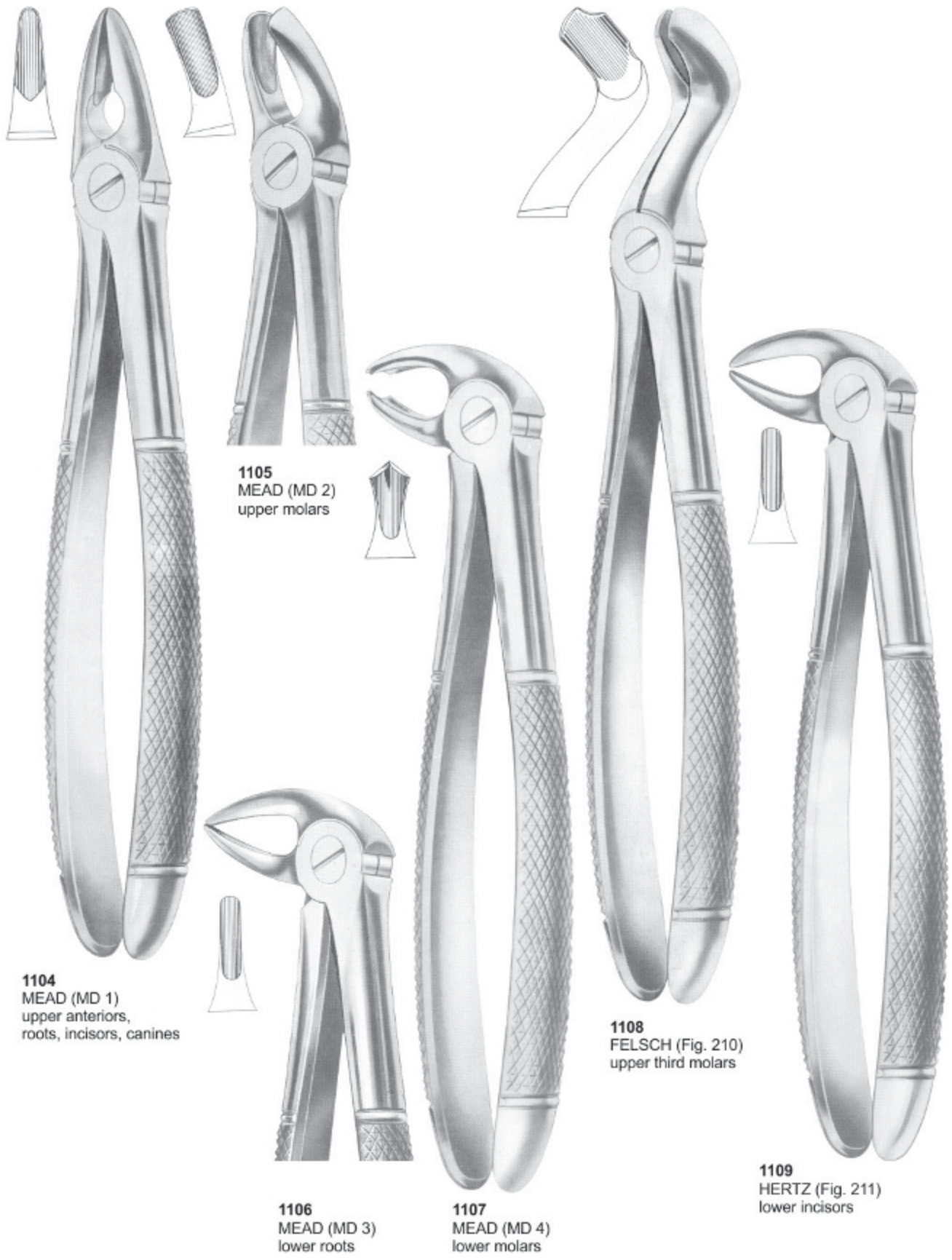

**1104**  
 MEAD (MD 1)  
 upper anteriors,  
 roots, incisors, canines

**1105**  
 MEAD (MD 2)  
 upper molars

**1106**  
 MEAD (MD 3)  
 lower roots

**1107**  
 MEAD (MD 4)  
 lower molars

**1108**  
 FELSCH (Fig. 210)  
 upper third molars

**1109**  
 HERTZ (Fig. 211)  
 lower incisors

## Wisdom Extraction Forceps



**1110**  
 ROUTURIER (Fig. 212)  
 ( 22 ½ L )  
 lower molars  
 and wisdom left



**1111**  
 ROUTURIER (Fig. 213)  
 ( 22 ½ R )  
 lower molars  
 and wisdom right



**1112**  
 ROUTURIER (Fig. 214)  
 ( 22 ½ L )  
 lower molars  
 and wisdom left



**1113**  
 ROUTURIER (Fig. 215)  
 ( 33 ½ R )  
 lower molars  
 and wisdom right



**1114**  
 RESECTION FORCEPS  
 ( 216/Witzel )  
 upper roots



## Extraction Forceps "English Pattern"



1115  
Fig. 5



1116  
Fig. 6

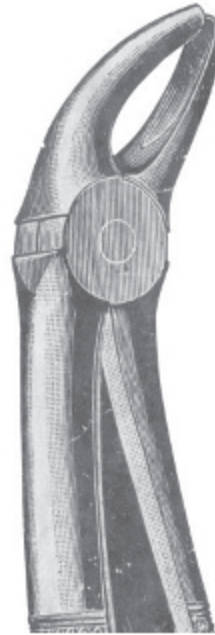

1117  
Fig. 9



1118  
Fig. 10



1119  
Fig. 11



1120  
Fig. 12



1121  
Fig. 14



1122  
Fig. 15



**Extraction Forceps "English Pattern"**



1123  
Fig. 25



1124  
Fig. 26



1125  
Fig. 27

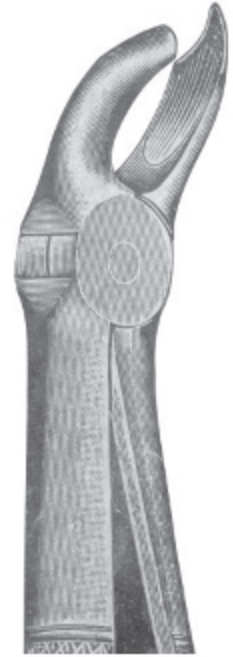

1126  
Fig. 28



1127  
Fig. 34



1128  
Fig. 35

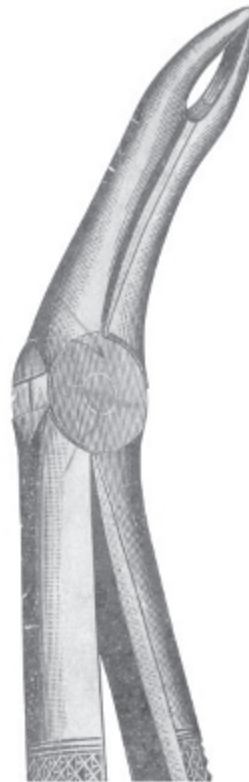

1129  
Fig. 42

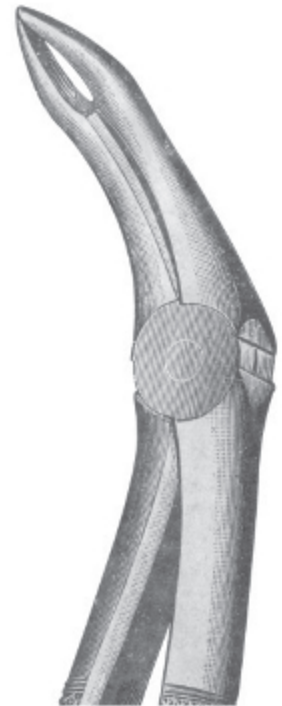

1130  
Fig. 43

**Extraction Forceps "English Pattern"**



**1131**  
 Fig. 44A



**1132**  
 Fig. 46

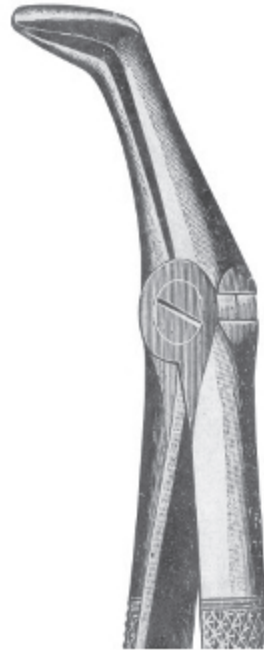

**1133**  
 Fig. 47



**1134**  
 Fig. 50A



**1135**  
 Fig. 74R



**1136**  
 Fig. 74L

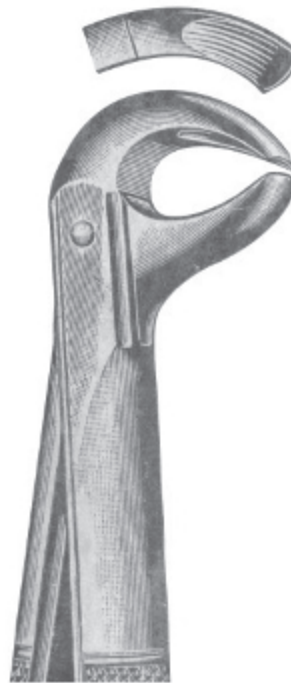

**1137**  
 Fig. 75R



**1138**  
 Fig. 75L

**Extraction Forceps "English Pattern"**



**1139**  
 Fig. 94



**1140**  
 Fig. 95



**1141**  
 Fig. 98



**1142**  
 Fig. 105



**1143**  
 Fig. 106



**1144**  
 Fig. 2002



**Extraction Forceps "with fitting handle"**



**1145**  
 Fig. 1  
 upper laterals  
 and canines



**1146**  
 Fig. 2  
 upper laterals  
 and canines



**1147**  
 Fig. 3  
 upper incisors  
 and canines

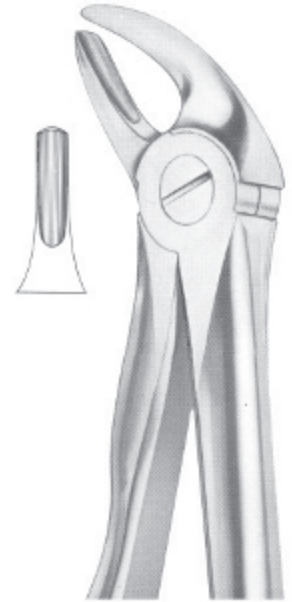

**1148**  
 Fig. 4  
 lower incisors  
 and canines



**1149**  
 Fig. 7  
 upper premolars

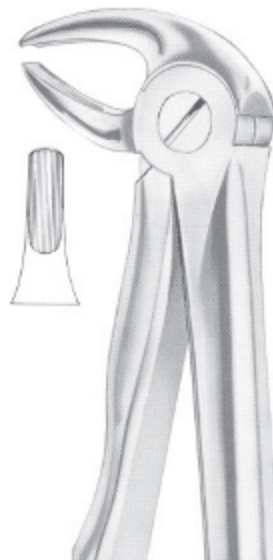

**1150**  
 Fig. 13  
 lower premolars



**1151**  
 Fig. 13S  
 lower premolars  
 for children



**Extraction Forceps "with fitting handle"**



**1152**  
 Fig. 17  
 upper molars right

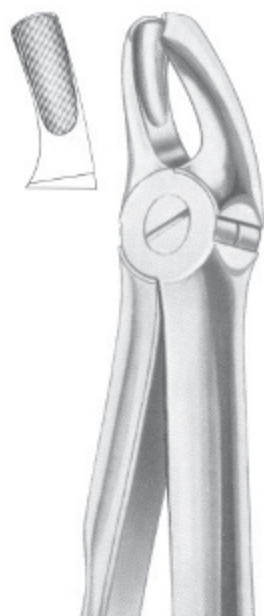

**1153**  
 Fig. 18  
 upper molars left

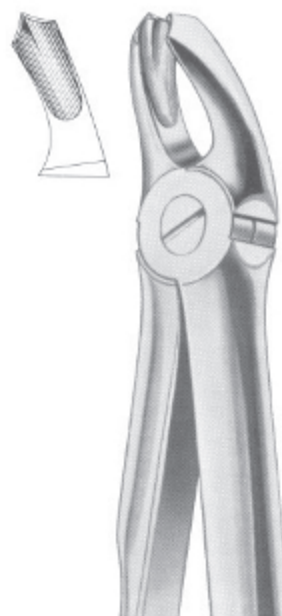

**1154**  
 Fig. 18A  
 upper molars



**1155**  
 Fig. 18B  
 upper molars



**1156**  
 Fig. 19  
 upper third molars



**1157**  
 Fig. 22  
 lower molars



**1158**  
 Fig. 22S  
 lower molars  
 for children

**Extraction Forceps "with fitting handle"**



**1159**  
 Fig. 29  
 upper roots



**1160**  
 Fig. 29S  
 upper roots  
 for children

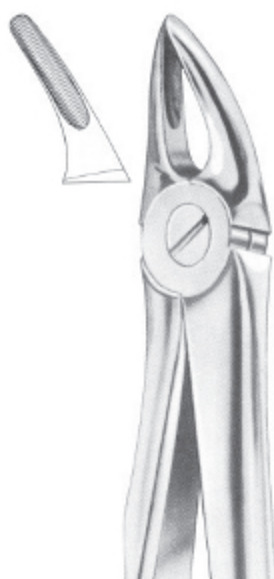

**1161**  
 Fig. 30  
 upper roots

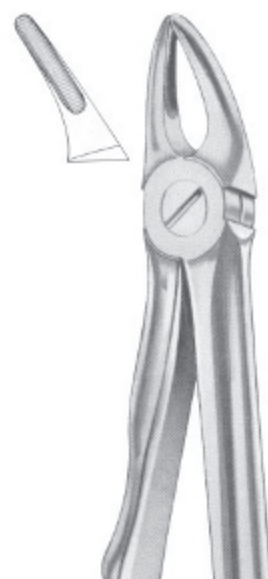

**1162**  
 Fig. 30S  
 upper roots  
 for children

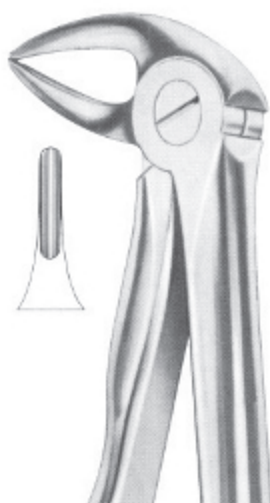

**1163**  
 Fig. 33  
 lower roots

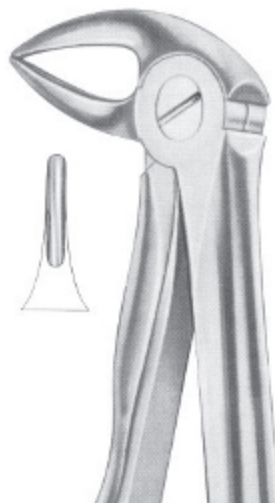

**1164**  
 Fig. 33A  
 lower roots

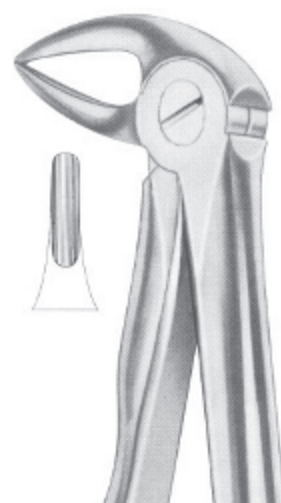

**1165**  
 Fig. 33B  
 lower roots

**Extraction Forceps "with fitting handle"**



**1166**  
 Fig. 33L  
 lower roots



**1167**  
 Fig. 33S  
 lower roots  
 for children



**1168**  
 Fig. 37  
 upper incisors  
 for children



**1169**  
 Fig. 39  
 upper incisors  
 for children



**1170**  
 Fig. 39A  
 upper molars  
 for children



**1171**  
 Fig. 39R  
 upper molars right  
 for children



**1172**  
 Fig. 39L  
 upper molars left  
 for children

**Extraction Forceps "with fitting handle"**



**1173**  
 Fig. 41  
 upper roots

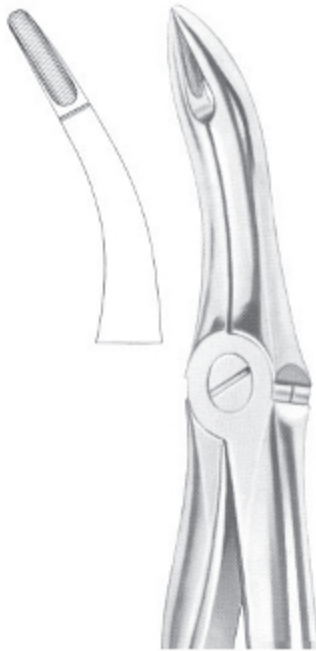

**1174**  
 Fig. 44  
 upper roots

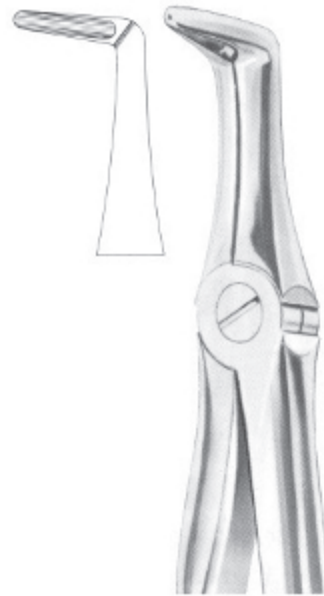

**1175**  
 Fig. 45  
 lower roots

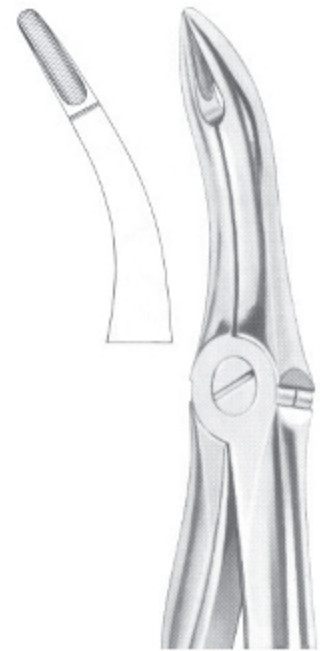

**1176**  
 Fig. 48  
 lower roots

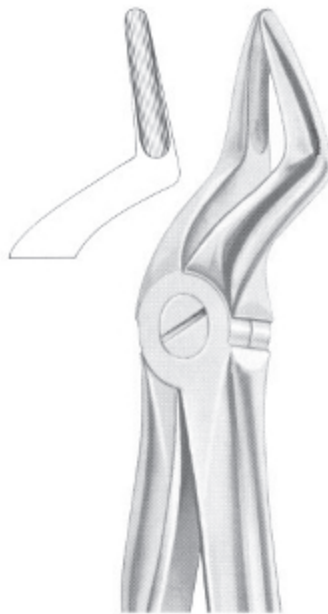

**1177**  
 Fig. 51  
 upper roots



**1178**  
 Fig. 51A  
 upper roots

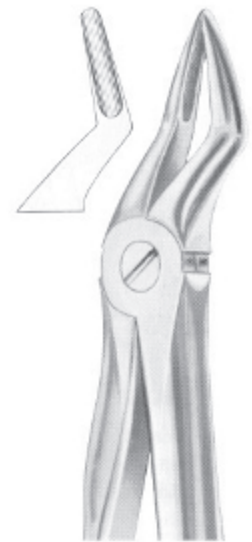

**1179**  
 Fig. 51S  
 upper roots  
 for children



**Extraction Forceps "with fitting handle"**



**1180**  
 Fig. 51L  
 upper roots

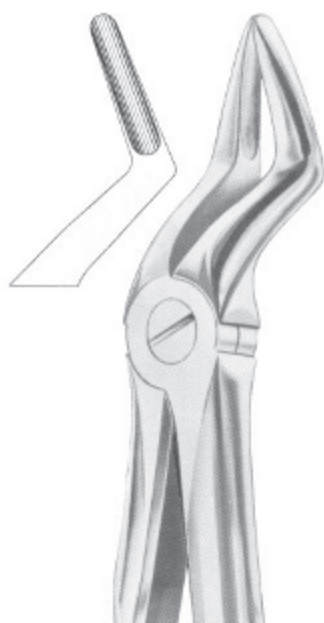

**1181**  
 Fig. 52  
 upper roots

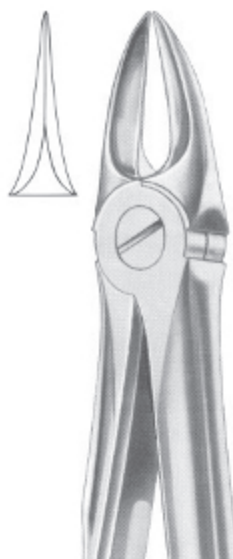

**1182**  
 Fig. 54  
 for separating  
 upper molars

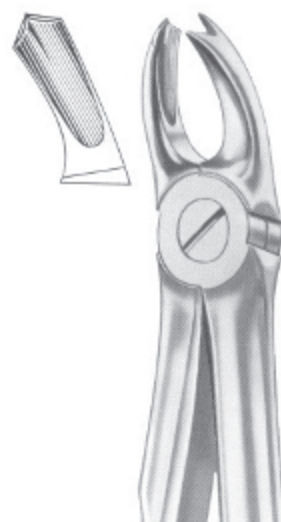

**1183**  
 Fig. 65R  
 upper molars right

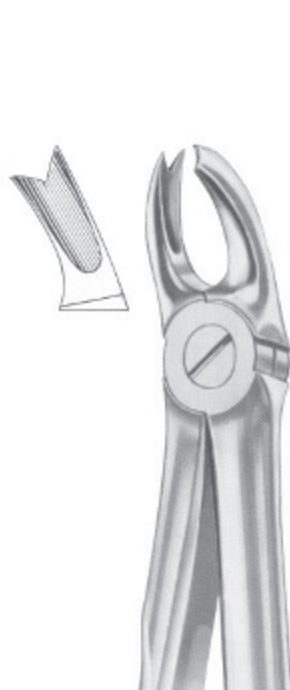

**1184**  
 Fig. 65L  
 upper molars left



**1185**  
 Fig. 67  
 upper third molars

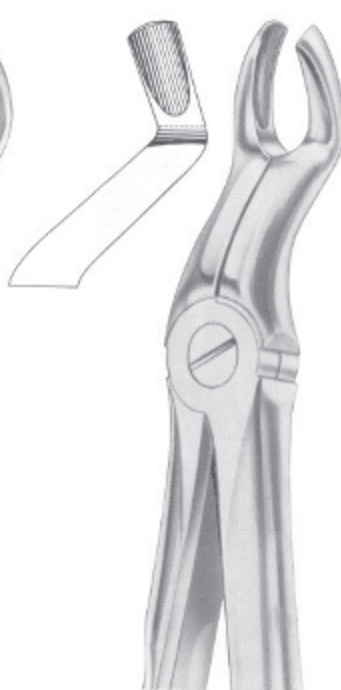

**1186**  
 Fig. 67A  
 upper third molars

**Extraction Forceps "with fitting handle"**



**1187**  
 Fig. 67 ½ R  
 upper third molars  
 right

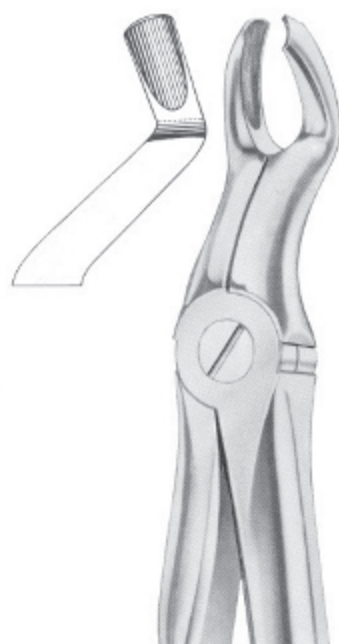

**1188**  
 Fig. 67 ½ L  
 upper third molars  
 left



**1189**  
 Fig. 73  
 lower molars



**1190**  
 Fig. 74  
 lower roots

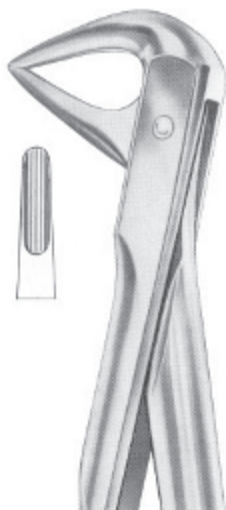

**1191**  
 Fig. 74M  
 lower roots



**1192**  
 Fig. 74N  
 lower roots



**1193**  
 Fig. 74XN  
 lower roots and  
 crowded incisors

**Extraction Forceps "with fitting handle"**



**1194**  
 Fig. 75  
 lower premolars



**1195**  
 Fig. 76  
 upper roots



**1196**  
 Fig. 76N  
 upper roots



**1197**  
 Fig. 81  
 lower premolars  
 and roots



**1198**  
 Fig. 76A  
 lower third molars



**1199**  
 Fig. 79  
 lower third molars

**Extraction Forceps "with fitting handle"**



**1200**  
 Fig. 86A  
 lower molars



**1201**  
 Fig. 86B  
 lower molars



**1202**  
 Fig. 86C  
 lower molars



**1203**  
 Fig. 99  
 lower molars



**1204**  
 Fig. 99 1/4  
 lower molars

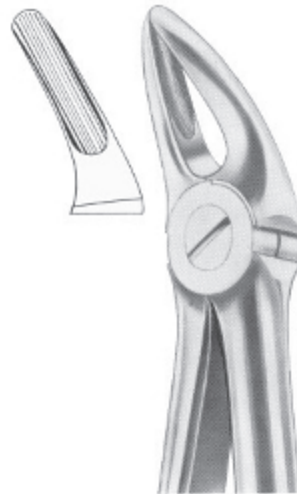

**1205**  
 Fig. 136  
 upper premolars  
 and roots



**1206**  
 Fig. 143  
 lower roots



## Extraction Forceps "for children"



**1207**  
 KLEIN (Fig. 217)  
 upper incisors



**1208**  
 KLEIN (Fig. 218)  
 upper premolars



**1209**  
 KLEIN (Fig. 219)  
 upper roots



**1210**  
 KLEIN (Fig. 220)  
 upper molars



**1211**  
 KLEIN (Fig. 221)  
 lower incisors



**1212**  
 KLEIN (Fig. 222)  
 lower molars



**1213**  
 KLEIN (Fig. 223)  
 lower roots



**1214**  
 ALBRECHT  
 Fig. 224  
 Deciduous

**1215**  
 ALBRECHT  
 Fig. 225  
 Deciduous

**Root Splinter Forceps**

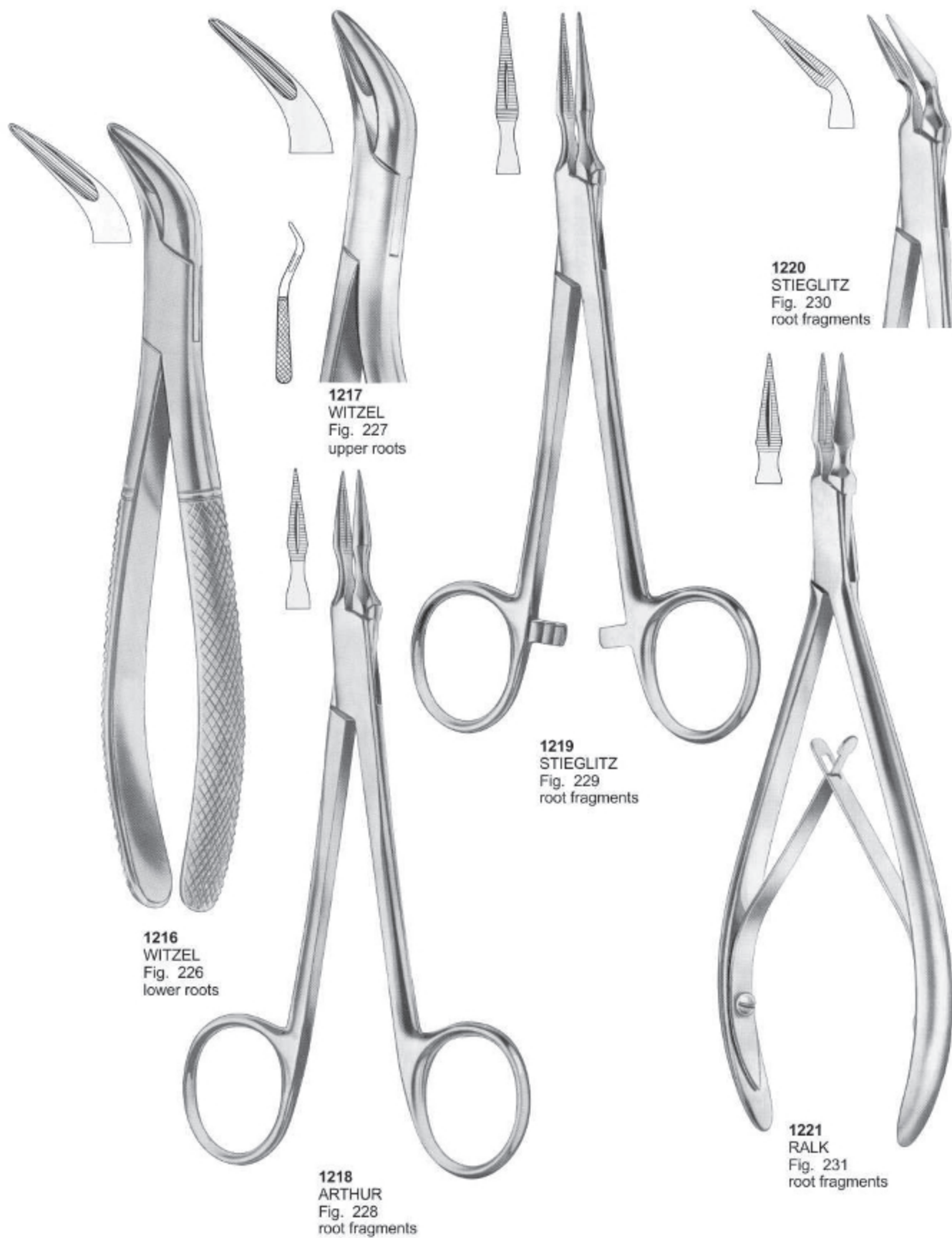

**1216**  
 WITZEL  
 Fig. 226  
 lower roots

**1217**  
 WITZEL  
 Fig. 227  
 upper roots

**1218**  
 ARTHUR  
 Fig. 228  
 root fragments

**1219**  
 STIEGLITZ  
 Fig. 229  
 root fragments

**1220**  
 STIEGLITZ  
 Fig. 230  
 root fragments

**1221**  
 RALK  
 Fig. 231  
 root fragments

**Extraction Forceps "American Pattern"**



**1222**  
**W1-WINTER**  
 upper centrals  
 and canines



**1223**  
 Fig. 1  
 upper incisors and roots



**1224**  
 Fig. 2  
 upper and lower roots



**1225**  
 Fig. 4  
 upper and lower premolars



**1226**  
**PHYSICK**  
 Fig. 5  
 lower third molars



**1227**  
 Fig. 6  
 separating  
 forceps



**Extraction Forceps "American Pattern"**



**1228**  
 Fig. 7  
 upper roots

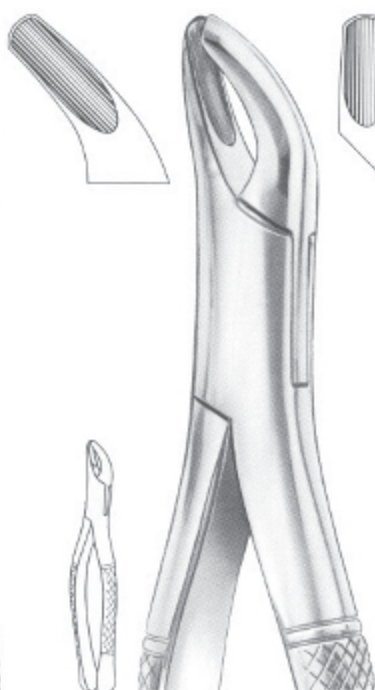

**1229**  
 Fig. 8  
 upper and lower  
 third molars



**1231**  
 Fig. 10H  
 upper molars



**1232**  
 Fig. 13  
 upper incisors

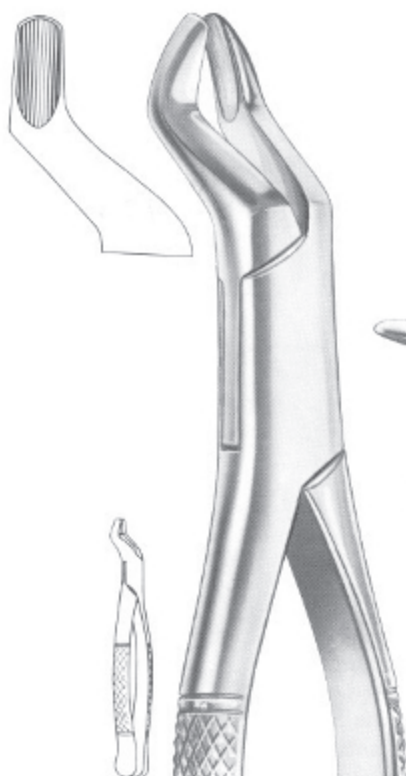

**1230**  
 Fig. 10S  
 upper molars



**1233**  
 Fig. 14  
 lower incisors



**Extraction Forceps "American Pattern"**

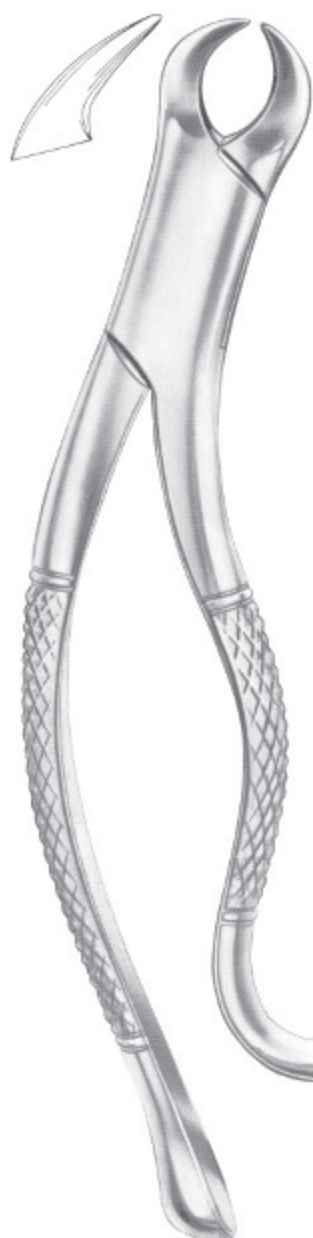

**1234**  
 Fig. 16  
 lower molars



**1235**  
 HARRIS  
 Fig. 15  
 lower molars



**1237**  
 HARRIS  
 Fig. 18R  
 upper molars right



**1238**  
 HARRIS  
 Fig. 18L  
 upper molars left



**1236**  
 Fig. 16S  
 lower molars  
 for children

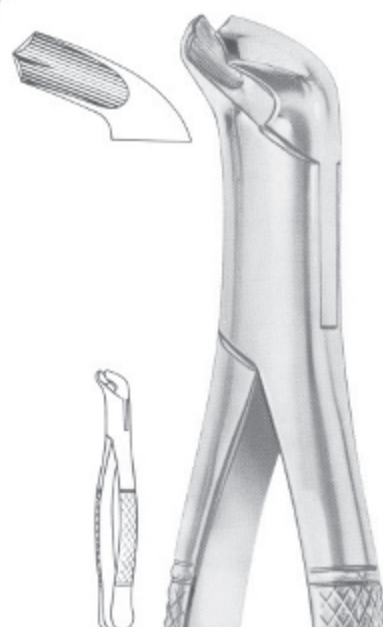

**1239**  
 Fig. 17  
 lower molars

**Extraction Forceps "American Pattern"**

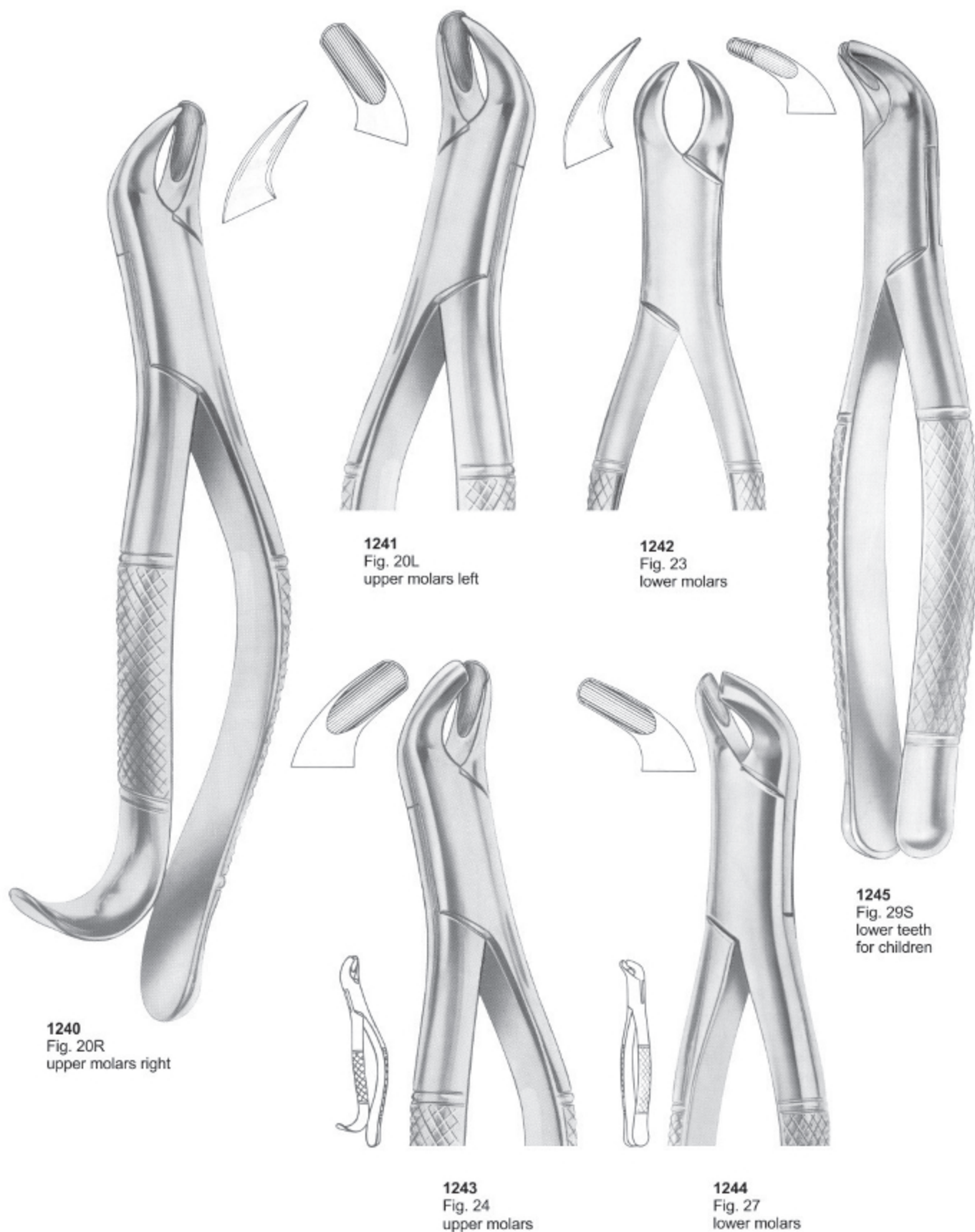

**Extraction Forceps "American Pattern"**



**1246**  
 Fig. 30S  
 upper teeth  
 for children



**1247**  
 PARMLY  
 Fig. 32  
 upper premolars  
 and molars

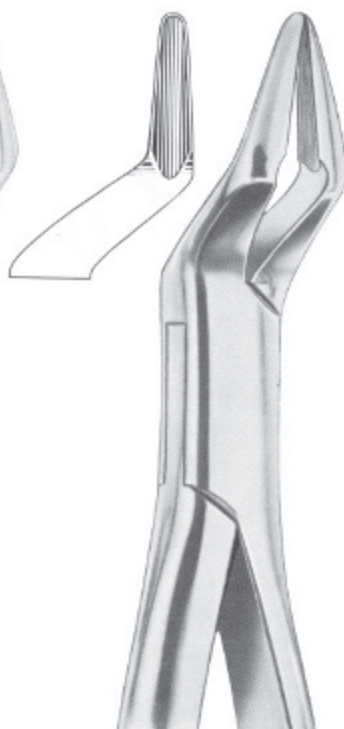

**1248**  
 PARMLY  
 Fig. 32A  
 upper premolars  
 and roots



**1249**  
 Fig. 34  
 lower anteriors  
 and roots

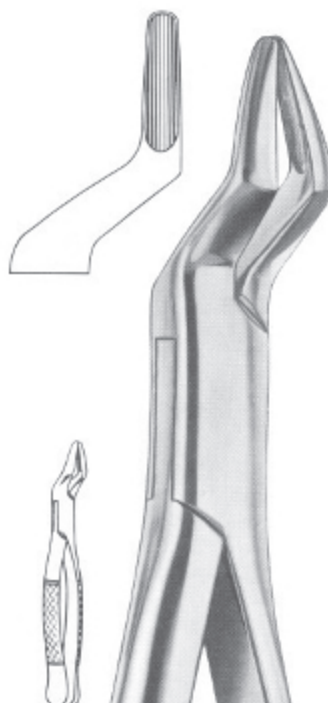

**1250**  
 Fig. 35  
 upper roots



**1251**  
 Fig. 36  
 lower anteriors  
 and roots



**Extraction Forceps "American Pattern"**



**1252**  
 Fig. 37  
 lower anteriors  
 and roots



**1254**  
 Fig. 53R  
 upper molars right

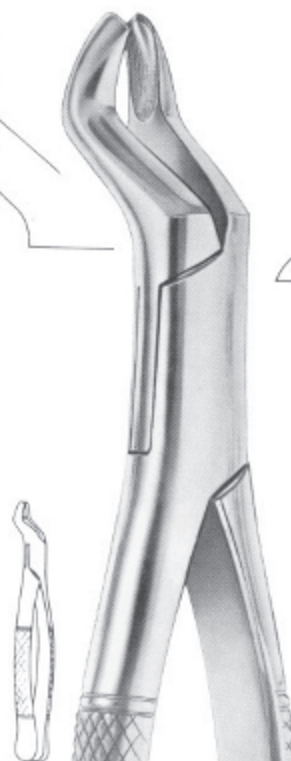

**1255**  
 Fig. 53L  
 upper molars left



**1257**  
 Fig. 65  
 upper incisors  
 and roots

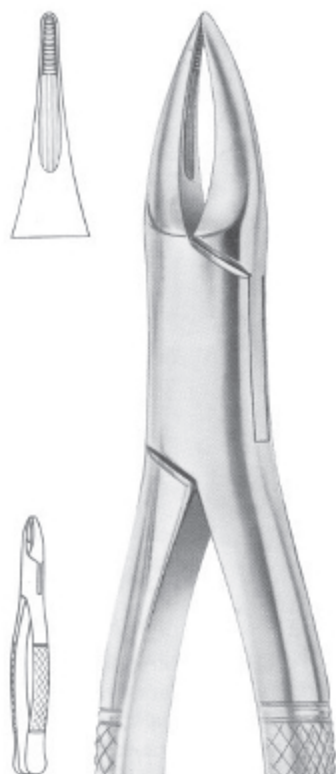

**1253**  
 Fig. 38  
 upper anteriors  
 and roots

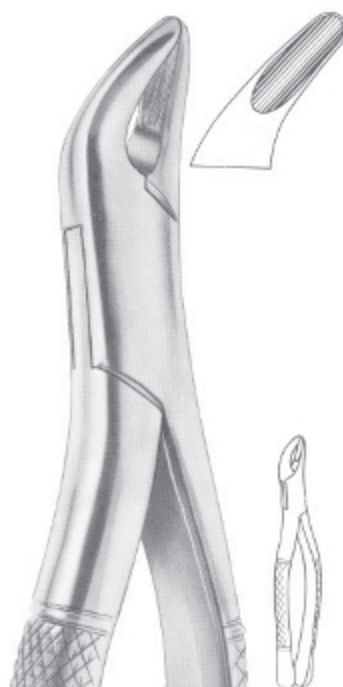

**1256**  
 Fig. 62  
 incisors, premolars,  
 deciduous teeth



**Extraction Forceps "American Pattern"**



**1258**  
 TOMES  
 Fig. 69  
 upper and lower roots



**1259**  
 TOMES  
 Fig. 85  
 lower canines,  
 premolars and molars



**1260**  
 NEVIUS  
 Fig. 88R  
 upper molars right



**1261**  
 THOMAS  
 Fig. 85A  
 lower canines,  
 premolars and molars



**1262**  
 NEVIUS  
 Fig. 88L  
 upper molars left

**Extraction Forceps "American Pattern"**

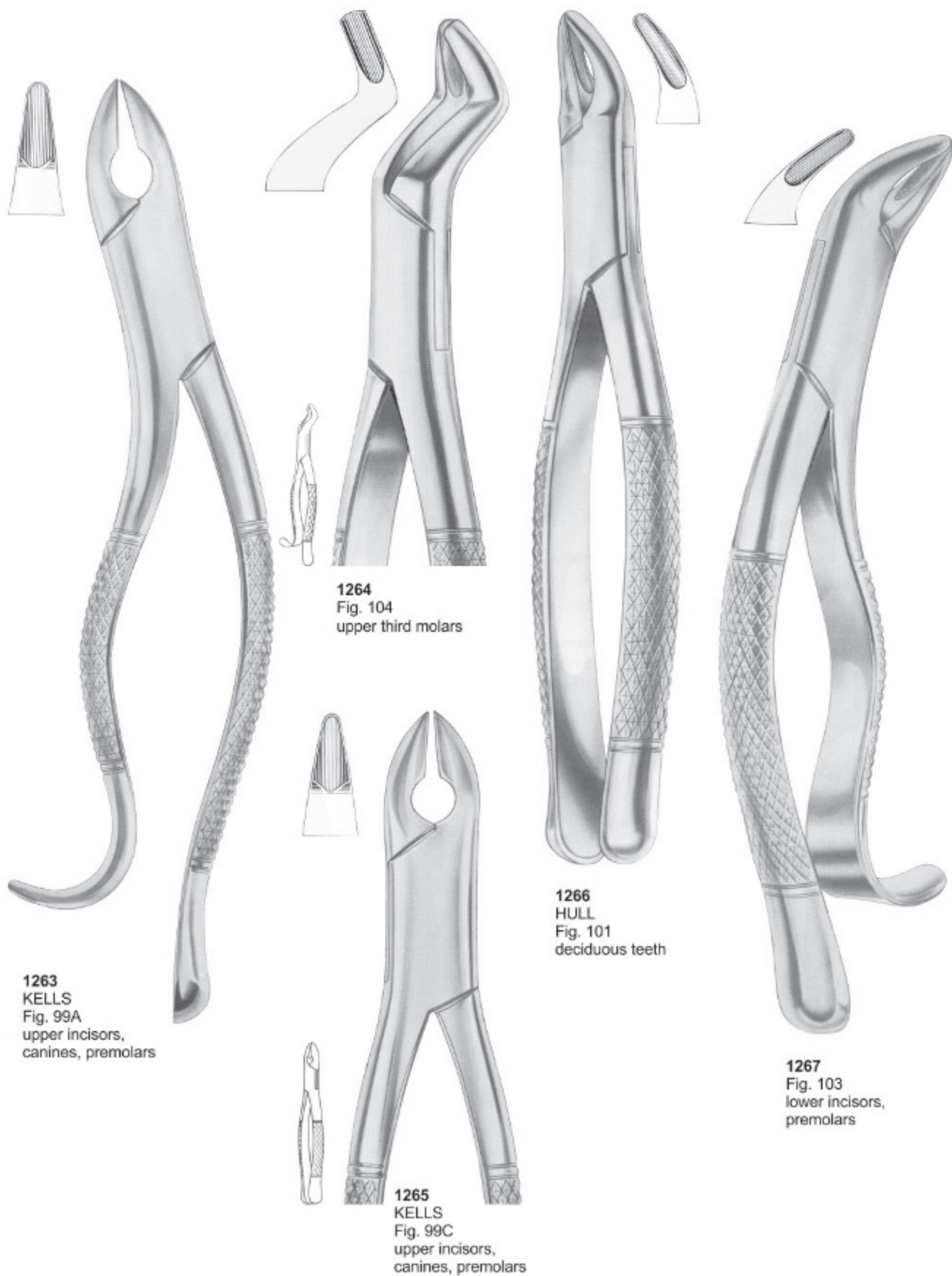

**1263**  
**KELLS**  
 Fig. 99A  
 upper incisors,  
 canines, premolars

**1264**  
 Fig. 104  
 upper third molars

**1266**  
**HULL**  
 Fig. 101  
 deciduous teeth

**1267**  
 Fig. 103  
 lower incisors,  
 premolars

**1265**  
**KELLS**  
 Fig. 99C  
 upper incisors,  
 canines, premolars

**Extraction Forceps "American Pattern"**



**1268**  
 CRYER  
 Fig. 150  
 lower incisors,  
 premolars, roots



**1269**  
 CRYER  
 Fig. 150A  
 upper incisors,  
 premolars, roots



**1271**  
 CRYER  
 Fig. 151  
 lower incisors,  
 premolars, roots



**1272**  
 CRYER  
 Fig. 151A  
 lower incisors,  
 premolars, roots

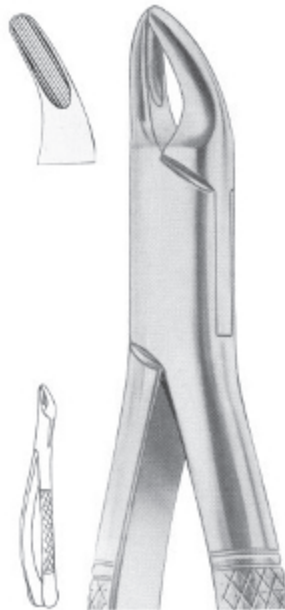

**1270**  
 CRYER  
 Fig. 150S  
 upper teeth for children



**1273**  
 CRYER  
 Fig. 151S  
 lower teeth  
 for children



**Extraction Forceps "American Pattern"**



**1274**  
 Fig. 203  
 lower incisors  
 and roots

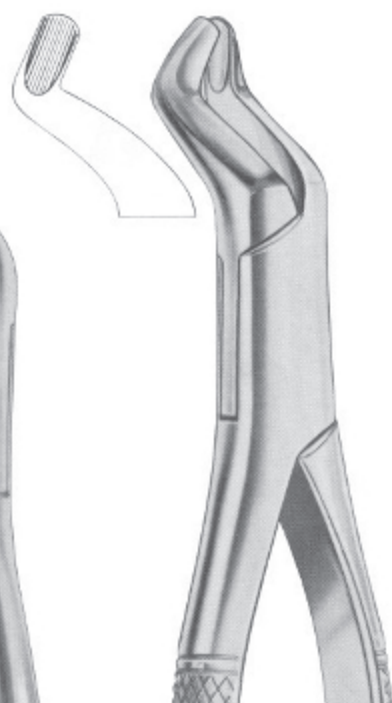

**1275**  
 Fig. 210S  
 upper third molars

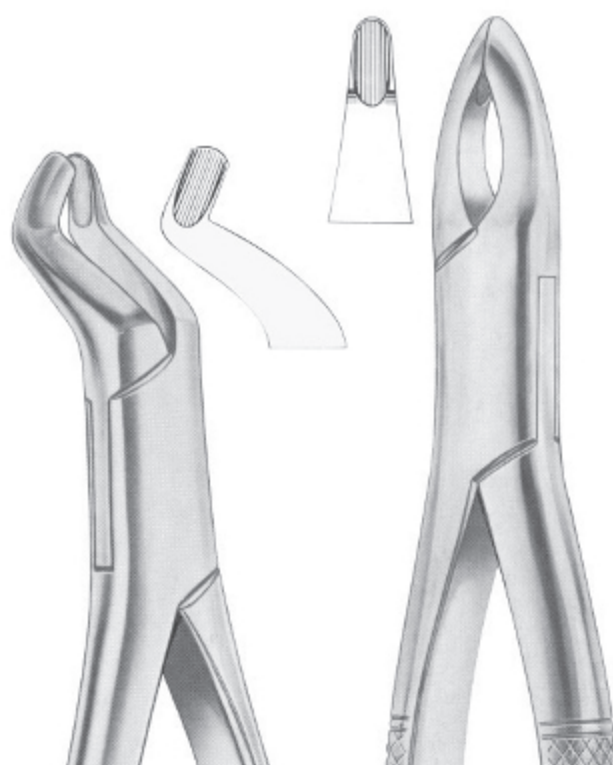

**1278**  
 Fig. 213  
 upper centrals and canines



**1276**  
 Fig. 201  
 upper incisors,  
 canines, premolars



**1277**  
 Fig. 210H  
 upper third molars

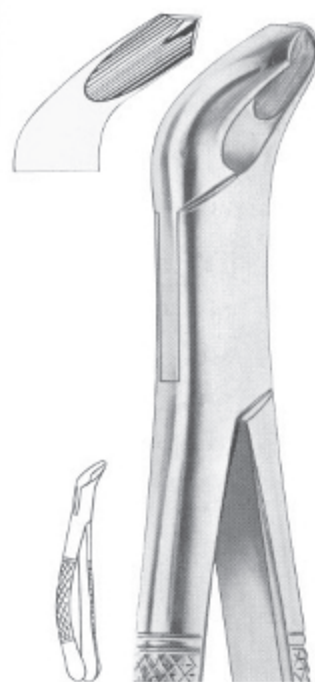

**1279**  
 Fig. 217  
 lower molars



## Extraction Forceps "American Pattern"

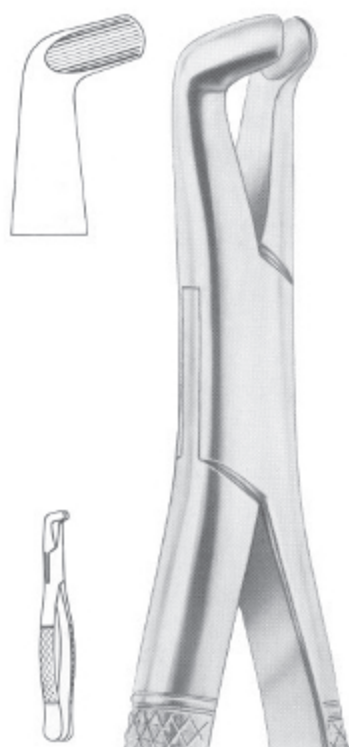

**1280**  
Fig. 222  
lower third molars



**1282**  
Fig. 286  
Swing lower molars



**1283**  
Fig. 288  
lower canines  
and premolars

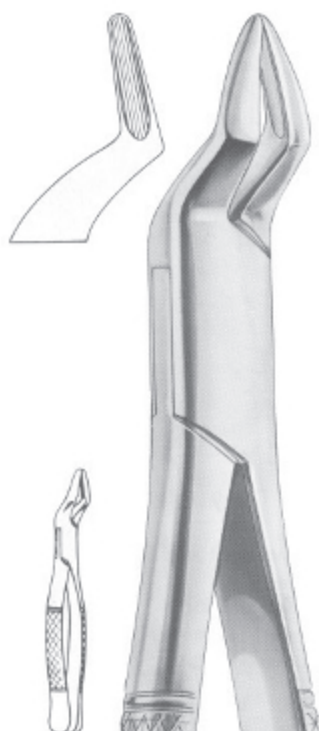

**1281**  
Fig. 286  
upper incisors and roots

**Extraction Forceps "American Pattern"**



**1284**  
 COHEN  
 Fig. 310  
 universal forceps

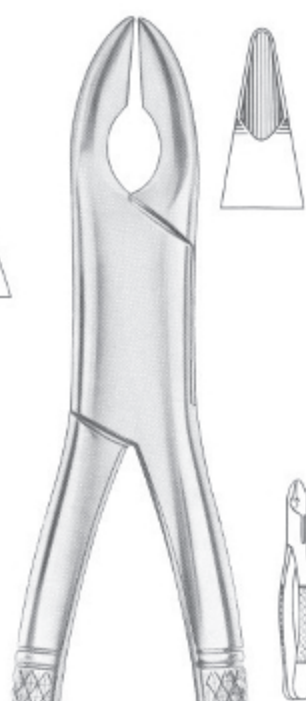

**1285**  
 NEVIUS  
 Fig. 320/10S  
 upper canines



**1287**  
 NEVIUS  
 Fig. 325/10H  
 upper canines



**1286**  
 HENAHAN  
 Fig. 315/1A  
 upper incisors



**1288**  
 STANDARD  
 Fig. 330/4  
 upper third molars

**Extraction Forceps "American Pattern"**



**1289**  
 WOODWARD  
 Fig. 335/FH  
 lower molars

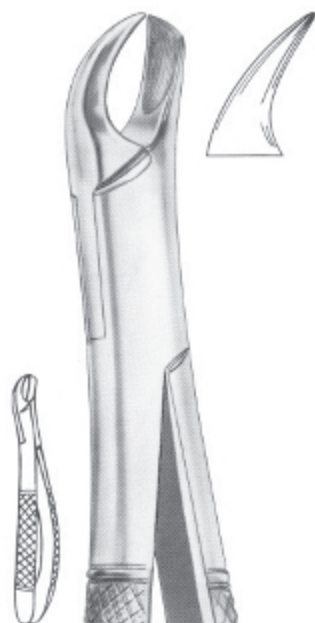

**1290**  
 Fig. 340/89  
 upper molars right



**1292**  
 Fig. 345/90  
 upper molars left

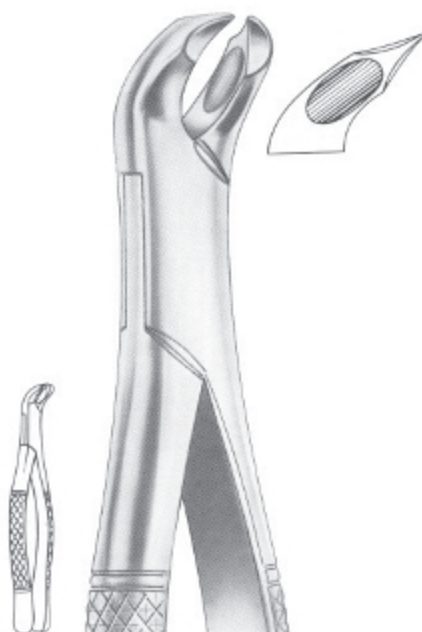

**1291**  
 WOODWARD  
 Fig. 335/FS  
 lower molars



**Forceps for Children "American Pattern"**



**1293**  
 Fig. 350/23S  
 lower molars

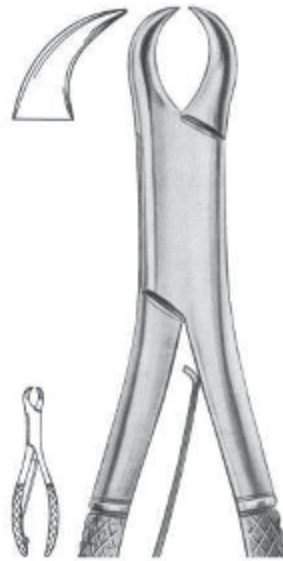

**1294**  
 Fig. 355/23SK  
 lower molars



**1295**  
 Forcep Fig. 301



**1295-A**  
 Forcep Fig. 300



**1296**  
 Fig. 360/17SK  
 lower molars



**1297**  
 Fig. 365/150SK  
 upper anteriors  
 and roots



**1298**  
 Fig. 370/151SK  
 lower anteriors  
 and roots



## Periosteal Elevators



**1299**  
Molt 9



**1300**  
Allen 9A



**1301**  
Prichard



**1302**  
Seldin



**1303**  
Goldman- Fox 14



**1304**  
West  
Dell W2

**Elevators**

Heidbrink Root - Tip Picks

Root Tip



1305  
DEL 78



1306  
DEL 79



1307  
DEL 80



1308  
DEL H1



1309  
DEL H2



1310  
DEL H3



1311  
DEL H2-3



1312  
POTT  
6X



1313  
POTT  
7X

## Periosteal Elevators



1314  
BUSER



1315  
OHI 10



1316  
HOWARD 9H



1317  
FREER



1318  
FREER 15



1319  
FREER 16



**Root Elevators**

lower jaw, left side

lower jaw, right side



**1320**  
 BEIN  
 Fig. 4



**1331**



**1332**

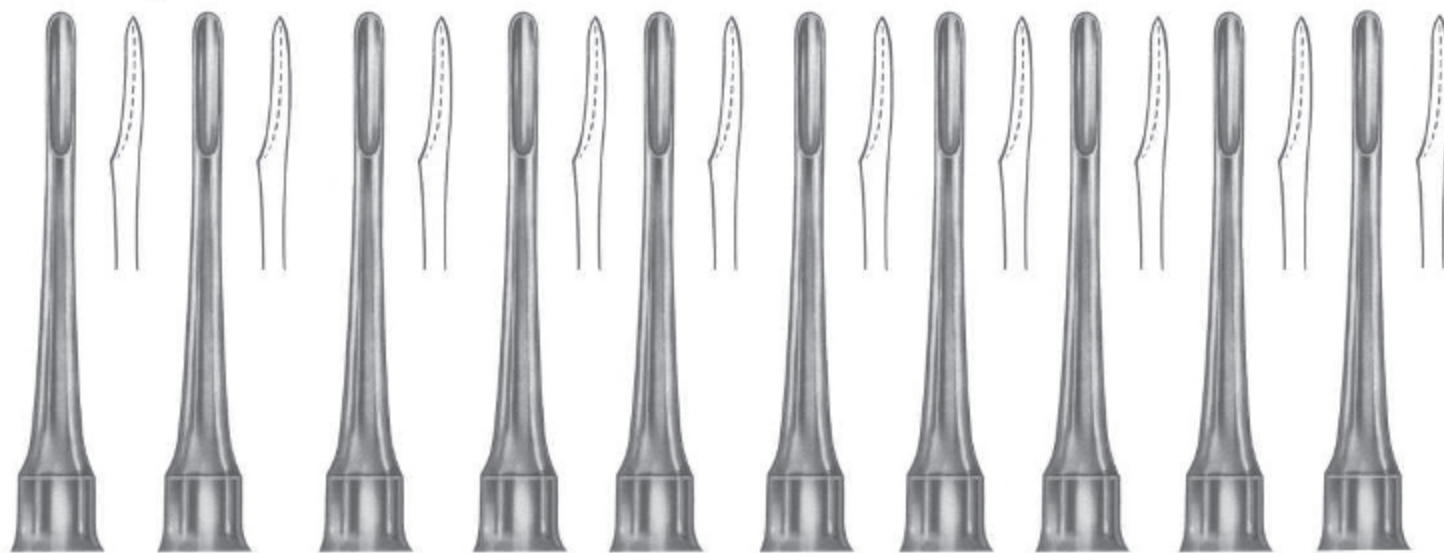

**1321**  
 BEIN  
 1.0 mm

**1322**  
 BEIN  
 1.5 mm

**1323**  
 BEIN  
 2.0 mm

**1324**  
 BEIN  
 2.5 mm

**1325**  
 BEIN  
 3.0 mm

**1326**  
 BEIN  
 3.5 mm

**1327**  
 BEIN  
 4.0 mm

**1328**  
 BEIN  
 4.5 mm

**1329**  
 BEIN  
 5.0 mm

**1330**  
 BEIN  
 5.5 mm

**Root Elevators**



**1333**  
BEIN



**1334**  
BEIN  
Fig. 1



**1335**  
BEIN  
Fig. 2



**1336**  
BEIN  
Fig. 0



**1337**  
BEIN  
Fig. 3



**1338**  
BEIN  
Fig. 4



**1339**  
BEIN  
Fig. 5



**1340**  
BEIN  
Fig. 6

**Root Elevators**



**1341**  
 CRYER  
 Fig. 3



**1342**  
 CRYER  
 Fig. 4



**1343**  
 CRYER  
 Fig. 12



**1344**  
 CRYER  
 Fig. 27



**1345**  
 CRYER  
 Fig. 28



**1346**  
 CRYER  
 Fig. 27S



**1347**  
 CRYER  
 Fig. 28S



**1348**  
 SELDIN  
 Fig. 2



**1349**  
 SELDIN  
 Fig. 3



**1350**  
 SELDIN  
 Fig. 4L



**1351**  
 SELDIN  
 Fig. 4R



**1352**  
 SELDIN  
 Fig. 1L



**1353**  
 SELDIN  
 Fig. 1R



## Elevators & Root Screws



1354



1355



1356



1357



1358



1359



1360

## Root Screws



1362  
 Morrison  
 2.0 mm



1363  
 Morrison  
 2.5 mm



1364  
 Morrison  
 3.0 mm



1361  
 Morrison  
 3.5 mm

**Root Elevators**



**1365**  
IS-APICAL



**1366**  
APICAL  
2 mm  
Fig. 1



**1367**  
APICAL  
3 mm  
Fig. 2



**1368**  
APICAL  
4 mm  
Fig. 3



**1369**  
APICAL  
4.5 mm  
Fig. 4



**1370**  
APICAL  
2 mm  
Fig. 5



**1371**  
APICAL  
3 mm  
Fig. 6



**1372**  
APICAL  
4 mm  
Fig. 7



**1373**  
APICAL  
4.5 mm  
Fig. 8



**1374**  
APICAL  
Fig. 9



**1375**  
WINTER  
Fig. 14 L



**1376**  
WINTER  
Fig. 14 R



**1377**  
HEIDBRINK  
Fig. 1



**1378**  
HEIDBRINK  
Fig. 2



**1379**  
FLOHR  
Fig. 1



**1380**  
FLOHR  
Fig. 2



**1381**  
APICAL  
Fig. 1



**1382**  
APICAL  
Fig. 2

**Root Elevators**



**1383**  
**IS-CRYER**



**1384**  
**CRYER**  
 Fig. 1



**1385**  
**CRYER**  
 Fig. 2



**1386**  
**IS-COUPLAND**



**1387**  
**COUPLAND**  
 Fig. 1



**1388**  
**COUPLAND**  
 Fig. 2



**1389**  
**COUPLAND**  
 Fig. 3



**Root Elevators**



**1390**  
Fig. 1



**1391**  
Fig. 2



**1392**  
Fig. 3



**1393**  
FLOHR  
Fig. 1

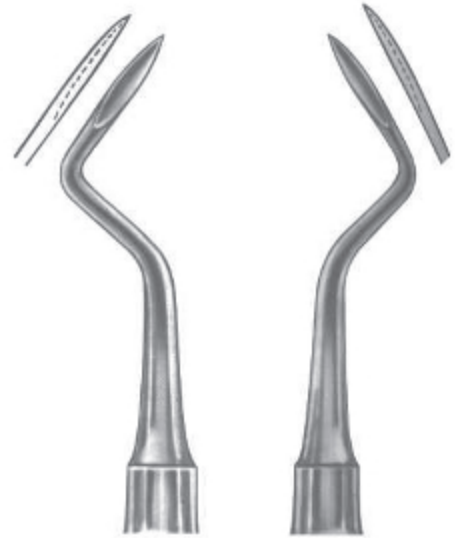

**1394**  
FLOHR  
Fig. 2

**1395**  
FLOHR  
Fig. 3

## Root Elevators



1396  
KOPP  
Fig. 1



1397  
KOPP  
Fig. 2



1403  
KOPP  
Fig. 1



1404  
KOPP  
Fig. 2



1396  
KOPP



1398  
KOPP  
Fig. 3



1399  
KOPP  
Fig. 4



1402  
KOPP



1405  
KOPP  
Fig. 3



1406  
KOPP  
Fig. 4



1400  
KOPP  
Fig. 5



1401  
KOPP  
Fig. 6

**Root Elevators**



**1407**  
HYLIN



**1407**  
HYLIN  
Fig. 1



**1408**  
HYLIN  
Fig. 2



**1409**  
BEIN

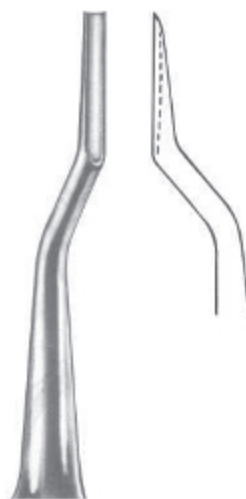

**1409**  
BEIN  
Fig. 1

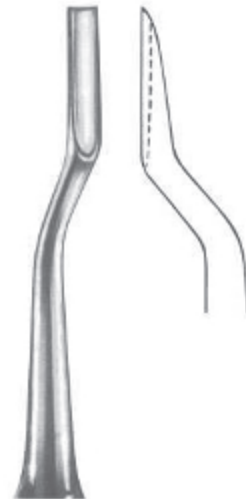

**1410**  
BEIN  
Fig. 2



**1411**  
BEIN  
Fig. 3



**1412**  
BEIN  
Fig. 4

**Root Elevators**



**1413**  
 WARWICK-JAMES  
 Fig. 1



**1413**  
 Warwick-James  
 Fig. 2



**1414**  
 Warwick-James  
 Fig. 3



**1415**  
 London-Hospital  
 Fig. 1



**1415**  
 London-Hospital  
 Fig. 2



**1416**  
 London-Hospital  
 Fig. 3

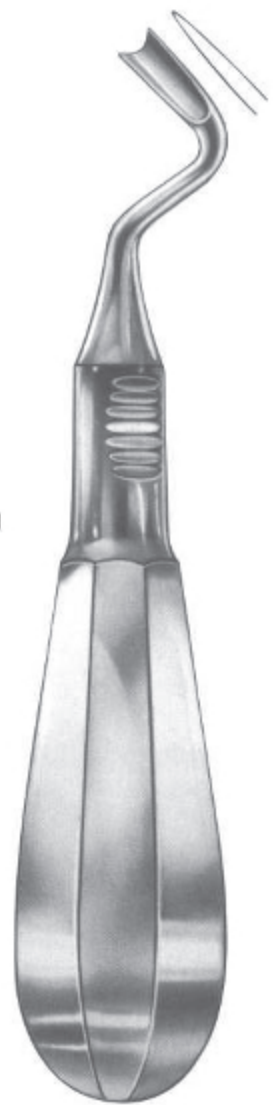

**1417**  
 OTT



**Root Elevators**



**1418**  
 CHOMPRET  
 Fig. 1



**1419**  
 CHOMPRET  
 Fig. 2



**1420**  
 CHOMPRET  
 Fig. 3



**1421**  
 CHOMPRET  
 Fig. 4



**1423**  
 Fig. 1



**1422**  
 Fig. 2

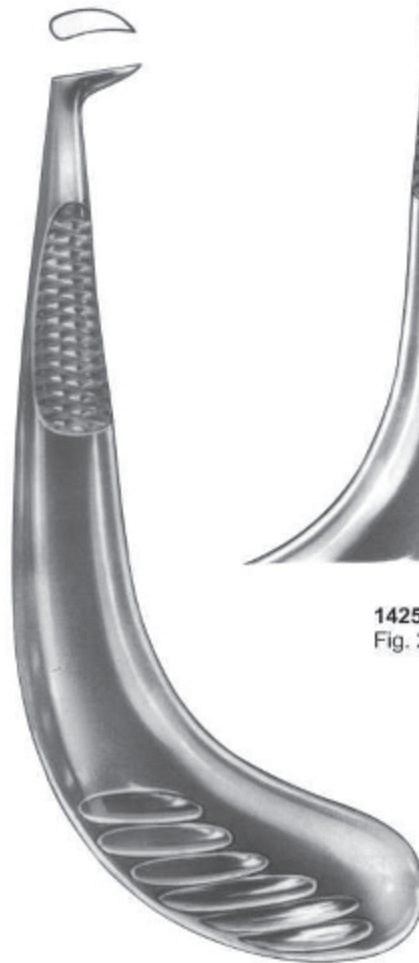

**1424**  
 Fig. 1



**1425**  
 Fig. 2



**1426**  
 APICAL

## Root Tip Elevators



1427  
IS-Fig. 1



1428  
Fig. 2



1429  
Fig. 3



1430  
HEIDBRINK  
Fig. 1



1431  
HEIDBRINK  
Fig. 2



1432  
HEIDBRINK  
Fig. 3



1438  
MEAD  
MD1

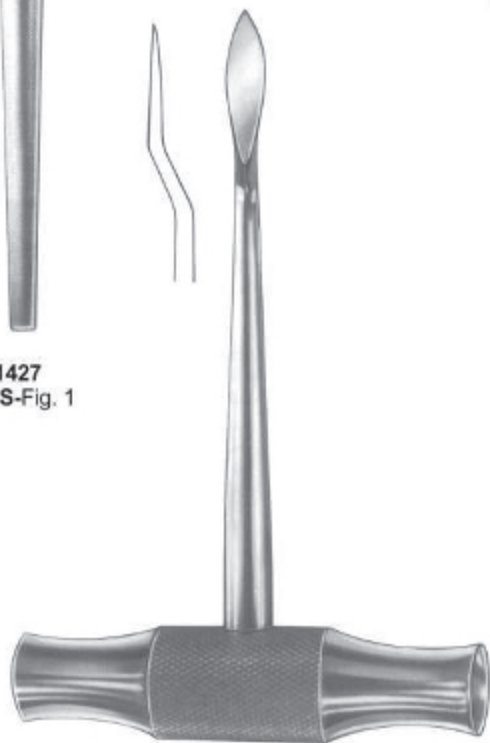

1433  
LECLUSE



1434  
MEAD  
MD-5 A



1435  
MEAD  
MD-6 A



1436  
MEAD  
MD-7 A



1437  
MEAD  
MD-8

**Root Elevators**



**1439**  
 WINTER  
 Fig. 1L



**1440**  
 WINTER  
 Fig. 1R



**1441**  
 WINTER  
 Fig. 2L



**1442**  
 WINTER  
 Fig. 2R



**1439**  
 WINTER



**1443**  
 WINTER  
 Fig. 11L



**1444**  
 WINTER  
 Fig. 11R



**1445**  
 WINTER  
 Fig. 12L



**1446**  
 WINTER  
 Fig. 12R



**1447**  
 WINTER  
 Fig. 14L



**1448**  
 WINTER  
 Fig. 14R

**Root Elevators**



**1449**  
 BARRY  
 Fig. 1



**1450**  
 BARRY  
 Fig. 2



**1451**  
 BARRY  
 Fig. 3



**1452**  
 BARRY  
 Fig. 4



**1449**  
 BARRY



**1453**  
 BARRY  
 Fig. 11



**1454**  
 BARRY  
 Fig. 12



**1455**  
 BARRY  
 Fig. 17



**1456**  
 BARRY  
 Fig. 18



## Root Elevators



1458  
CRYER  
Fig. 26



1459  
SELDIN  
Fig. 27



1460  
CRYER  
Fig. 28



1461  
CRYER  
Fig. 29



1462  
HEIDBRINK  
Fig. 22



1463  
HEIDBRINK  
Fig. 23



1457

## Root Elevators



1465  
KOPP  
Fig. 31



1466  
KOPP  
Fig. 32



1467  
KOPP  
Fig. 33



1468  
KOPP  
Fig. 34



1469  
KOPP  
Fig. 35



1470  
KOPP  
Fig. 44

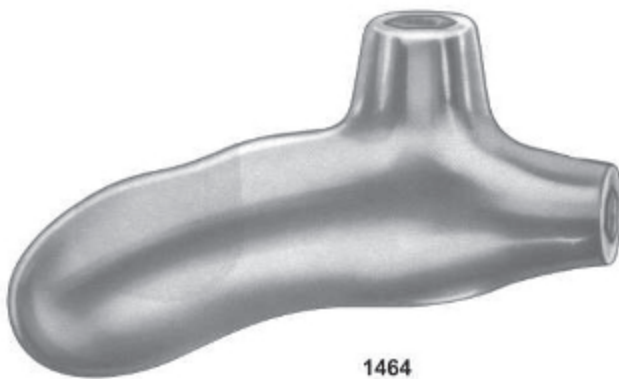

1464

**Root Elevators**



**1472**  
 HEIDBRINK  
 Fig. 10



**1473**  
 WINTER  
 Fig. 11



**1474**  
 WINTER  
 Fig. 12



**1475**  
 BARRY  
 Fig. 17



**1476**  
 BARRY  
 Fig. 18



**1477**  
 BARRY  
 Fig. 20



**1471**

**Root Elevators according to Dr. Sader,  
 with interchangeable working tips**



**1478**



**1479**



**1480**

**Elevator Plastic handle**

1481  
 Root Elevator, Plastic Handle, Set of 10 Pcs

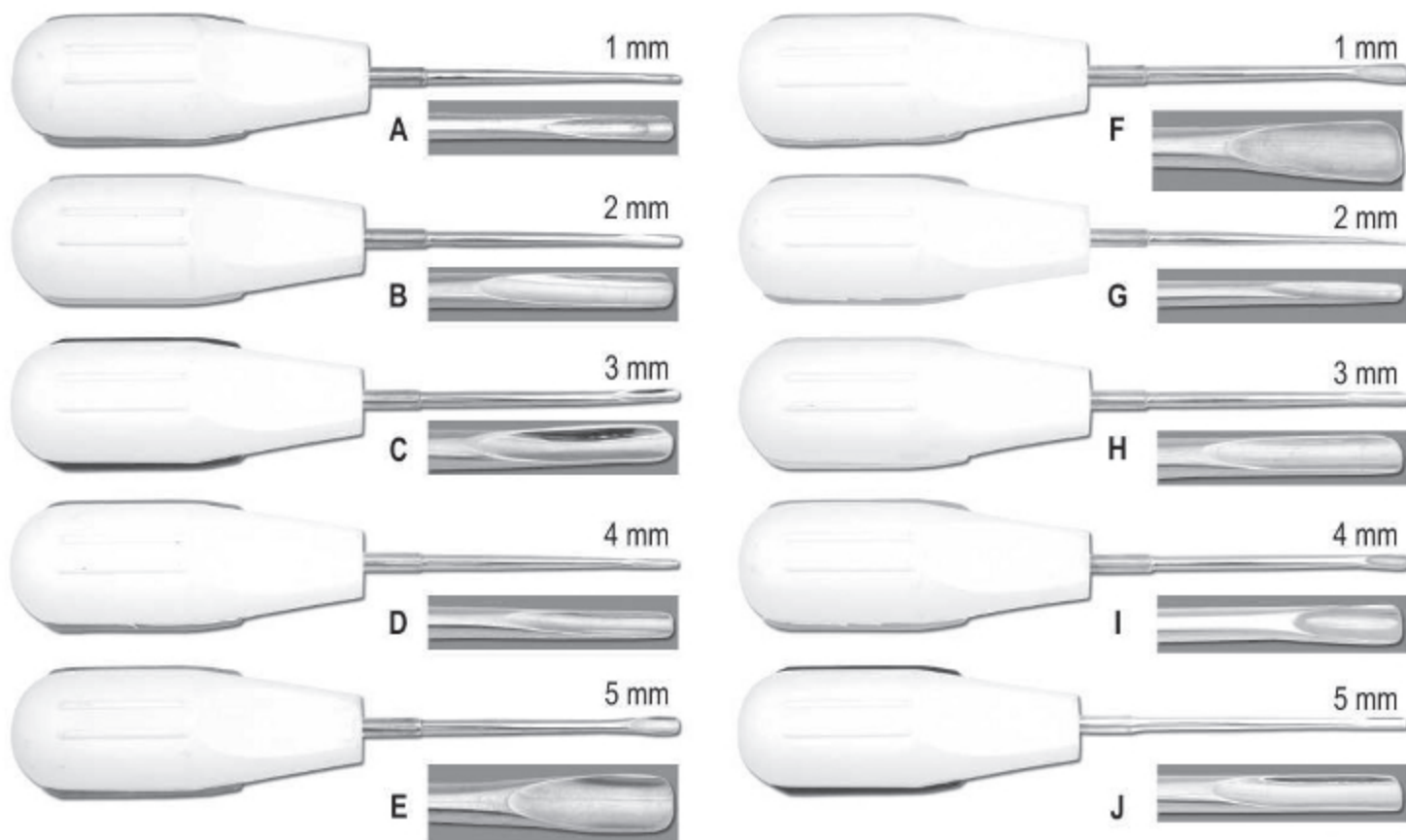

1482  
 Root Elevator, Plastic Handle, Set of 5 Pcs

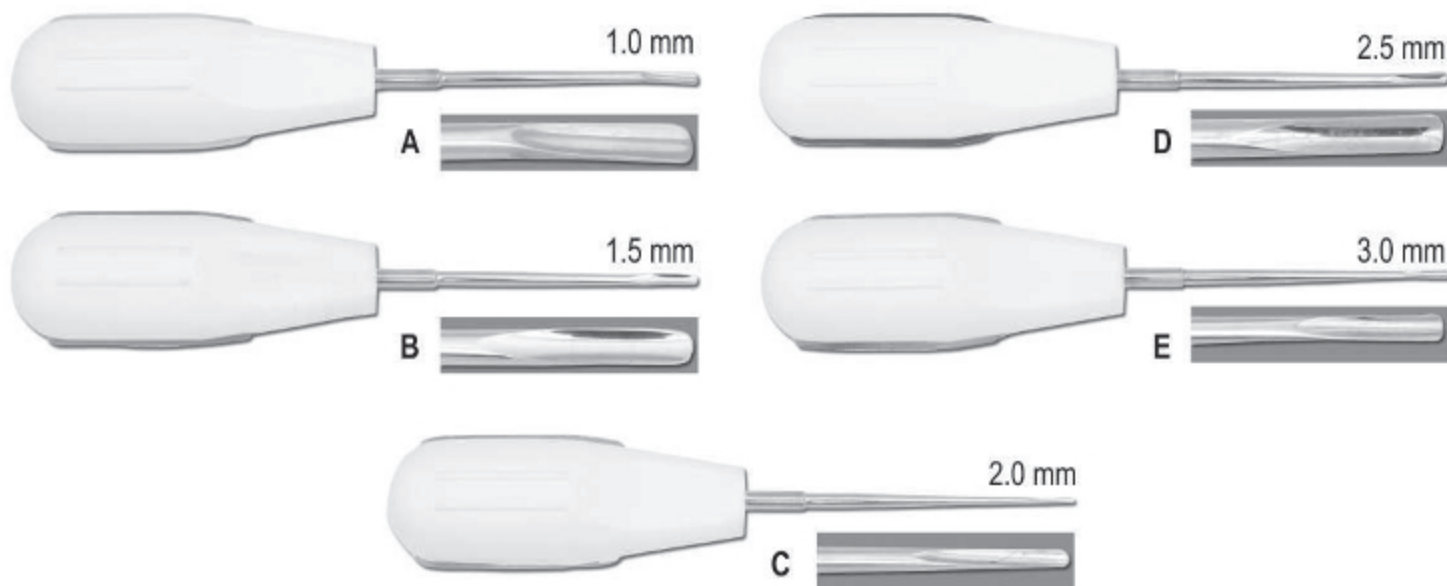



# SECTION 02

**SEASONED**  
*Take away the Beauty*  
Since 1985

- ▶ Scalpel Handles
- ▶ Handles
- ▶ Explorers
- ▶ Condensers
- ▶ Mouth Mirrors
- ▶ Scalars
- ▶ Probes
- ▶ Excavators

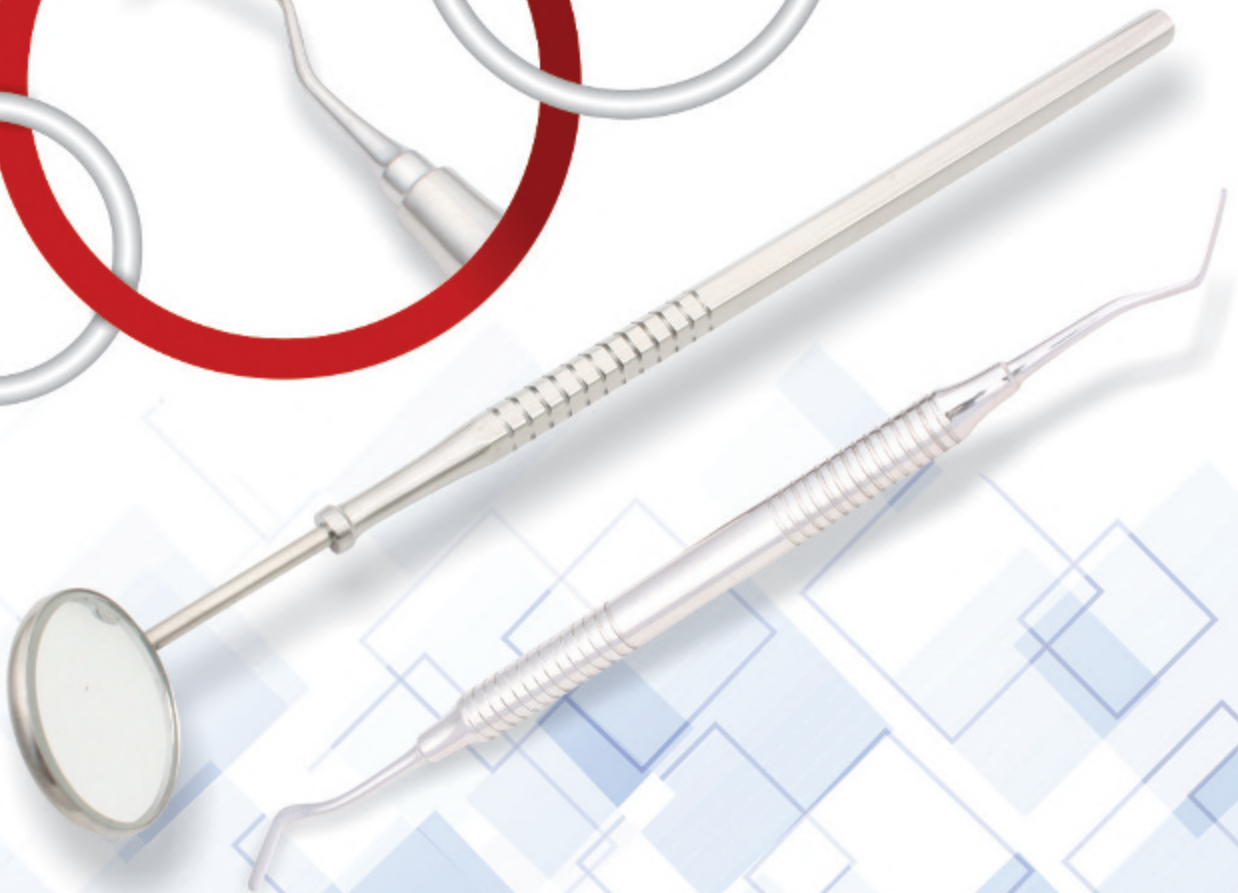

## Scalpel Handles



**1483**  
 Scalpel Handle Angle Of Blade Adjusts To Easily Get Around Corners  
 Adjustment Sets Blade From Straight To Back Angled  
 Locks In At 90°, 60°, 30°, Straight, -30°, -60° Angles



**1484**  
 Scalpel Handle  
 Fig. 5



**1485**  
 Scalpel Handle  
 Curved



**1486**  
 Fig. 3L



**1487**  
 Fig. 7



**1488**  
 Scalpel Handle  
 Fig. 4L, Curved  
 20 cm



**1489**  
 Fig. 3



**1490**  
 Fig. 3G



**1491**  
 Fig. 4



**1492**



**1493**  
 Scalpel Handle  
 4 D 14.0 cm



**1494**  
 Mess Holders



**1495**  
 Gouge  
 Blade Handle  
 Fig. 2 / 11.5 cm

## Handles

Handle For Mouth Mirrors, Probes, Explorers, Excavators, Carvers, Curettes & Scalers



**1496**

Handle No. 2 Standard Single Ended



**1497**

Handle Single Ended



**1498**

Handle Single Ended



**1499**

Handle Single Ended



**1500**

Octagonal Double Ended



**1501**

Octagonal Double Ended



**1502**

Octagonal Double Ended



**1503**

Handle No. 2 (Standard Double Ended)



**1504**

Octagonal Double Ended



**1505**

Tactile Tone Double Ended



**1506**

Tactile Tone Double Ended



**1507**

Tactile Tone Double Ended

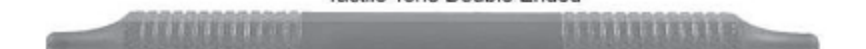

**1508**

Handle, Double Ended



**1509**

Double Ended



**1510**

Tactile Tone Double Ended



**1511**

Tactile Tone Double Ended



## Handles & Mouth Mirrors

### Mouth Mirrors

#### Plane



**1514**  
Fig.6  
Ø 26 mm



**1515**  
Fig.5  
Ø 24 mm



**1516**  
Fig.4  
Ø 22 mm

#### Magnifying



**1517**  
Fig.6  
Ø 26 mm



**1518**  
Fig.5  
Ø 24 mm



**1519**  
Fig.4  
Ø 22 mm

#### Front surface



**1520**  
Fig.6  
Rhodium  
Ø 26 mm  
Front surface



**1521**  
Fig.5  
Rhodium  
Ø 24 mm  
Front surface



**1522**  
Fig.4  
Rhodium  
Ø 22 mm  
Front surface

#### Plane



**1523**  
Fig.6  
Ø 26 mm



**1524**  
Fig.5  
Ø 24 mm



**1525**  
Fig.4  
Ø 22 mm

#### Magnifying



**1526**  
Fig.6  
Ø 26 mm



**1527**  
Fig.5  
Ø 24 mm



**1528**  
Fig.4  
Ø 22 mm

### Mouth Mirrors, Magnifying 1513-A Plain 1512-B

Fig. 00	Ø	8 mm
Fig. 0	Ø	10 mm
Fig. 1	Ø	14 mm
Fig. 2	Ø	16 mm
Fig. 3	Ø	18 mm
Fig. 4	Ø	20 mm
Fig. 5	Ø	22 mm
Fig. 6	Ø	24 mm
Fig. 7	Ø	26 mm
Fig. 8	Ø	28 mm
Fig. 9	Ø	30 mm
Fig. 10	Ø	32 mm



1513-A



**1512**  
Hollow Handle  
Fig.1



**1513**  
Hollow Handle  
Fig.2

With cone - socket



**Mirror Handle, Mouth Mirrors**



1529



1530



1531



1532



1533



1534



1535  
 Parallelometer  
 mouth mirror

1536  
 Parallelometer  
 mouth mirror  
 + handle  
 code 2101



1537  
 Tactile Tone  
 Single Ended



1538  
 Handle  
 Thompson  
 Single Ended



1539  
 Hollow Handle



1540  
 Hollow Handle  
 Stainless  
 Steel



1541  
 Cone-socket  
 Hollow Handle



1542  
 Hollow Handle



1543  
 Hollow Handle

**Scalers**

SCALERS - JAQUETTE

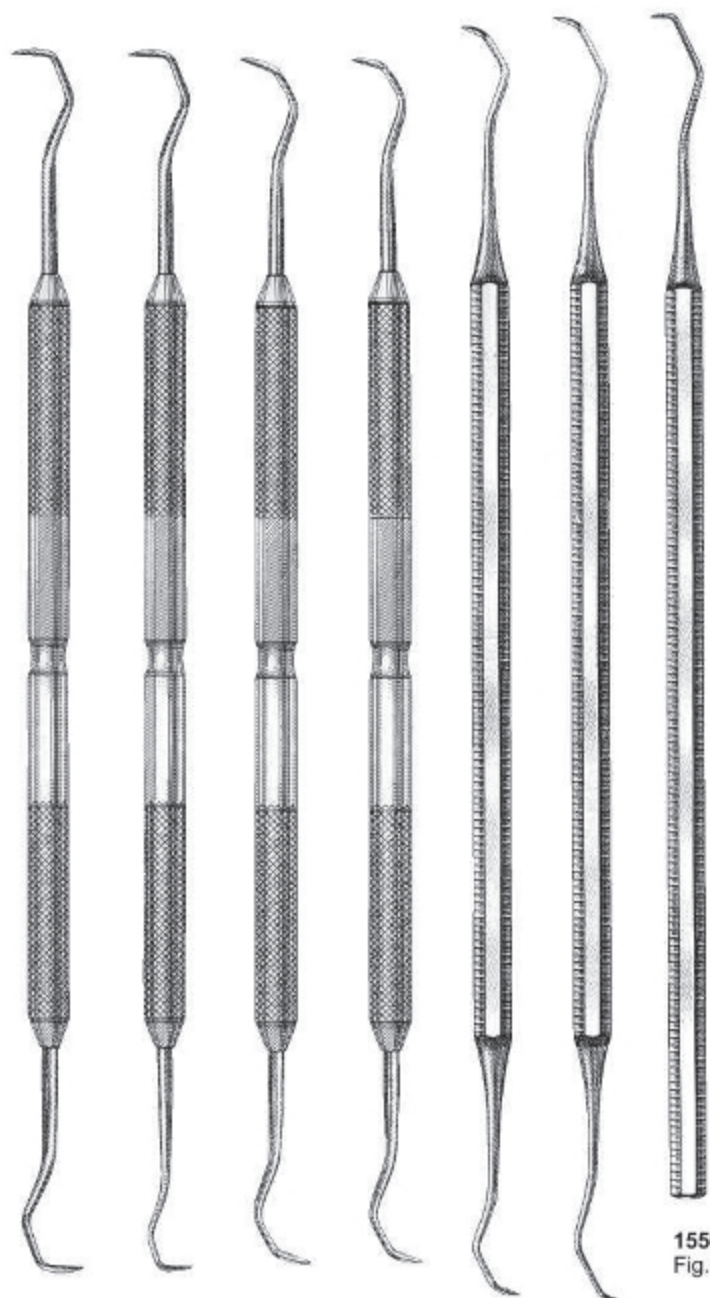

1550  
Fig.1

- 1544 1Y-1Y
- 1545 1Y-1YS
- 1546 2Y-3Y
- 1547 2YS-3YS
- 1548 2-3
- 1549 2S-3S

SCALERS - OCTAGONAL

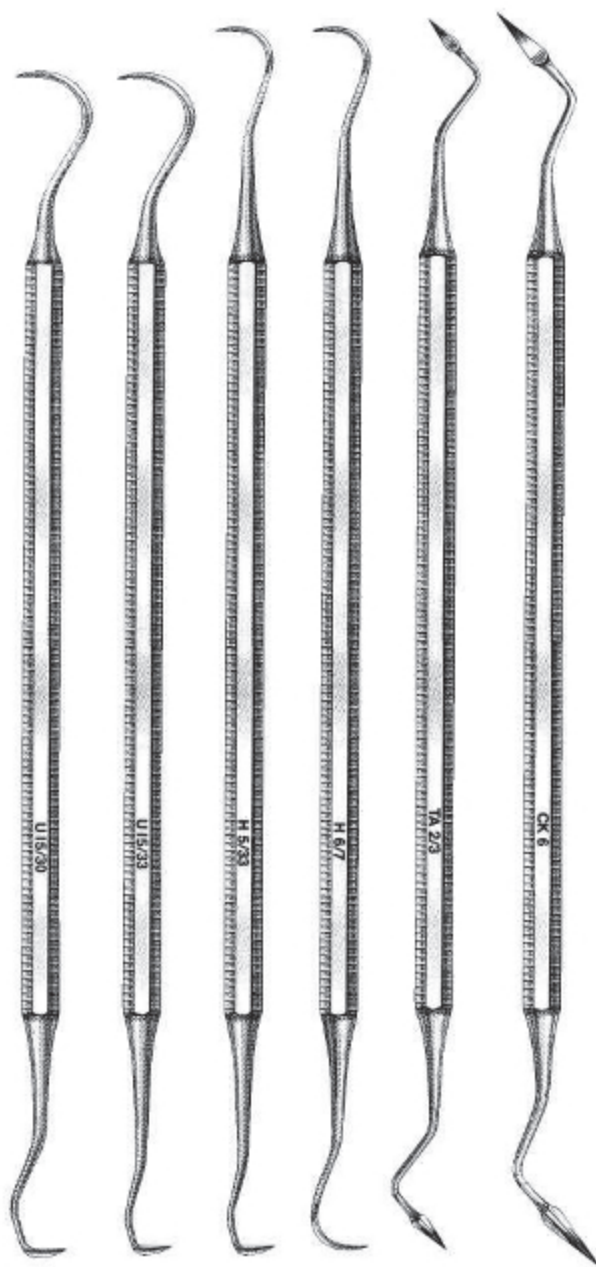

- 1551 U15-30
- 1552 U15-33
- 1553 H5-33
- 1554 H6-7
- 1555 Taylor 2-3
- 1556 CK6

**Scalers**



1557  
U15



1558  
No. 3



1559  
No. 12



1560  
WHITESIDE 1-0



1561  
WHITESIDE 2-0

**Scalers**



**1562**  
YAOUNGER/GOOD  
7-8



**1563**  
H5-33



**1564**  
204SD



**1565**  
H6-7



**1566**  
204S



**1567**  
TOWNER/JAQUETTE  
U15-30



**Scalers**



**1568**  
 JAQUETTE (33-U15)



**1569**  
 JAQUETTE  
 2Y-3Y



**1570**  
 JAQUETTE  
 30-U15



**1571**  
 JAQUETTE  
 2YS-3YS



**1572**  
 JAQUETTE  
 33-H5



**1573**  
 YOUNGER/GOOD  
 7-8



**1574**  
 204S



**1575**  
 204SD



**1576**  
 H6-7



**1577**  
 JAQUETTE  
 2S-3S



**1578**  
 JAQUETTE  
 1Y-1YS



**1579**  
 JAQUETTE  
 2-3

**Scalers**



**1580**  
 JAQUETTE (33-U15)



**1581**  
 S204



**1582**  
 Jack-Nebraska



**1583**  
 S204S



**1584**  
 Jaquette 1-U15



**1585**  
 S204SD



**1586**  
 Jaquette 2-3



**1587**  
 Goldman 6-7



**1588**  
 Jaquette 2S-3S



**1589**  
 Goldman Fox 21



**1590**  
 Jaquette 30-U15



**1591**  
 H5-U15



**1592**  
 Jaquette 30-33



**1593**  
 Jaquette 34-35



**1594**  
 Jaquette 31-32



**1595**  
 Thompson Jr.



**1596**  
 Jaquette 33-H5



**1597**  
 UT107-108



**1598**  
 U 6-7



**1599**  
 UP128



**1600**  
 128L

**Explorers**

Explorers Double Ended - Octagonal

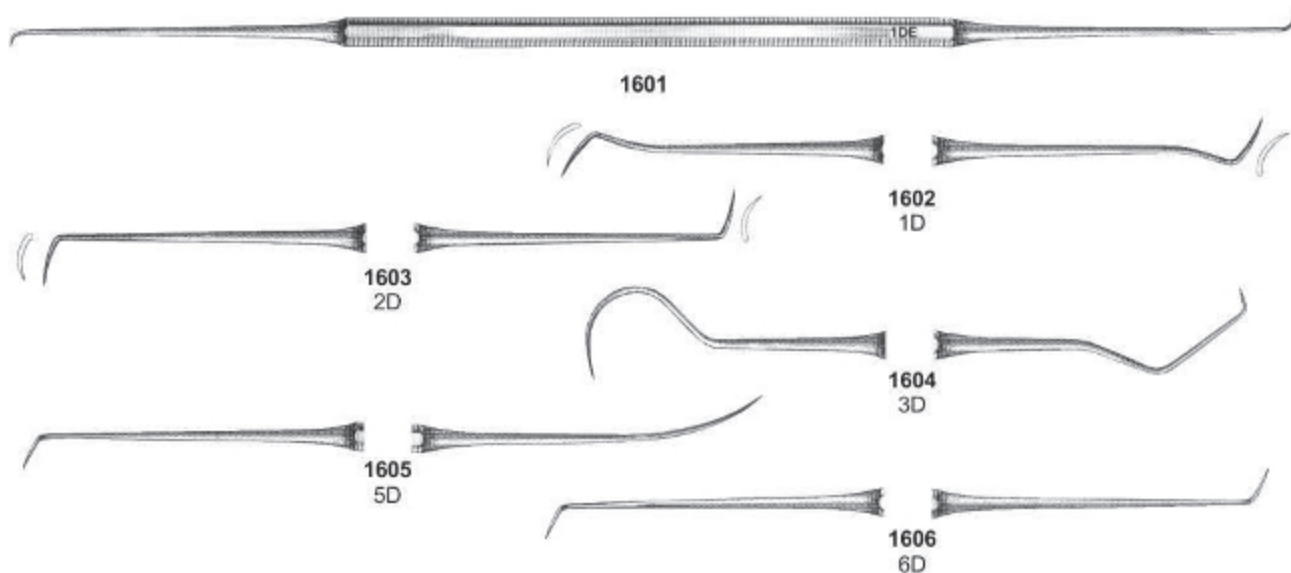

Explorers Double Ended - Standard

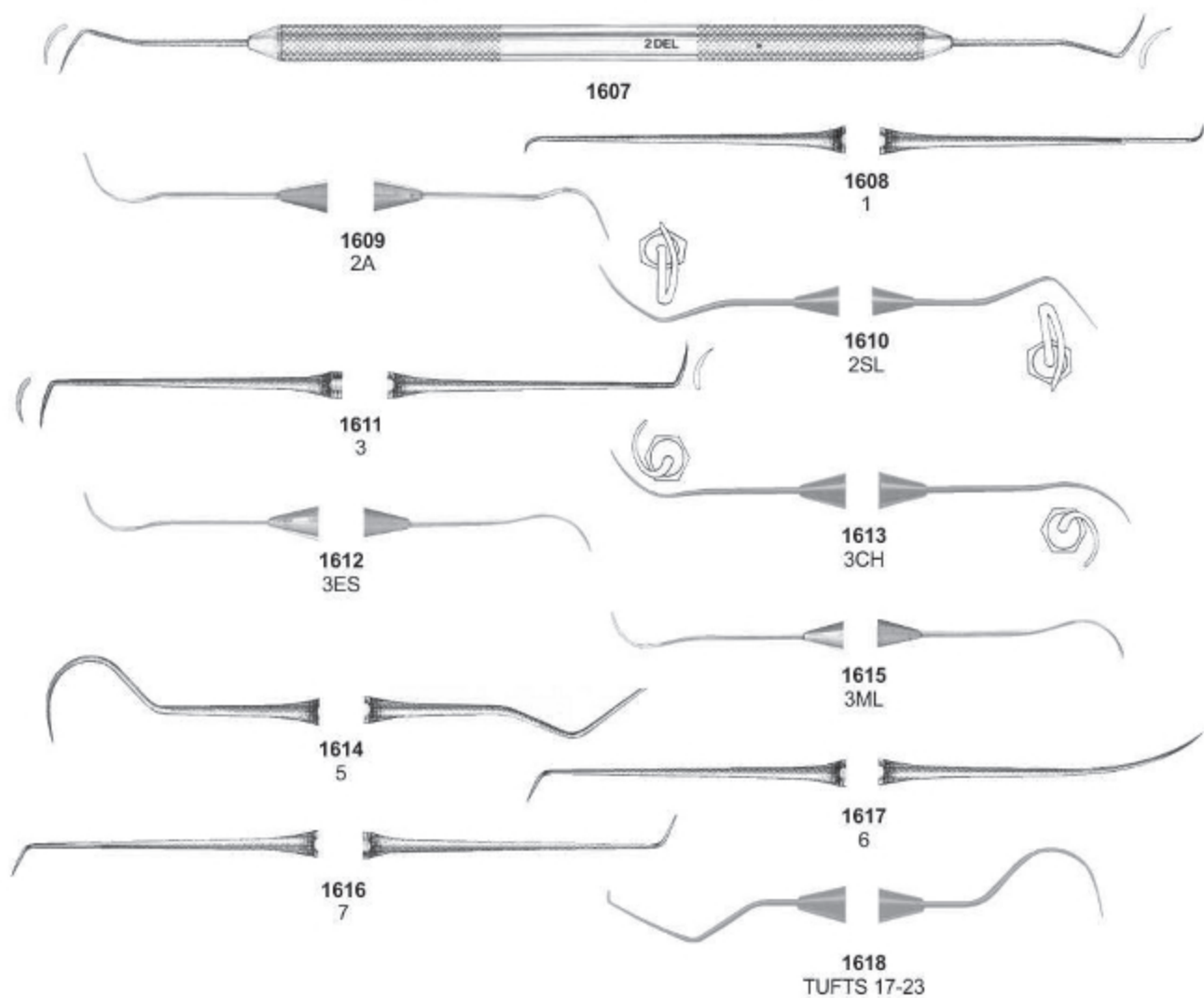

**Explorers**

Explorers Double Ended Tactile Tone



1619  
2A



1620  
2



1621  
1



1622  
2SL



1623  
3



1624  
3CH



1625  
3ES



1626  
3ML



1627  
5



1628  
6



1629  
7



1630  
16



1631  
TUFTS 17/23



**Explorer & Probes**

Explorers Single Ended - Octagonal

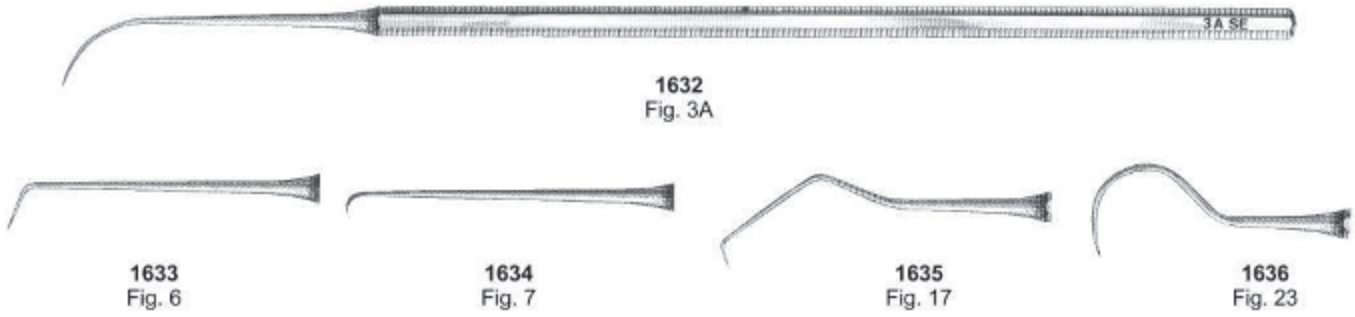

Explorers Single Ended - Standard

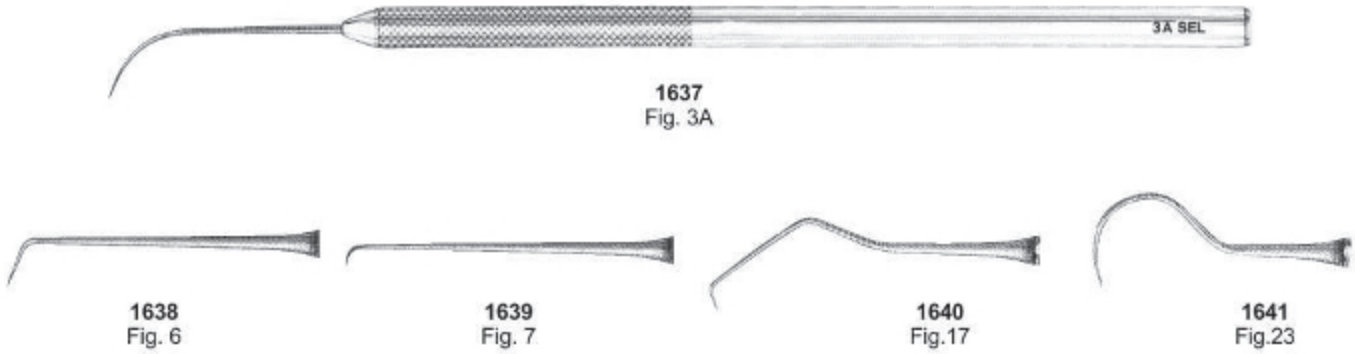

Probe / Explorer - Octagonal



Double Ended Probe - Octagonal

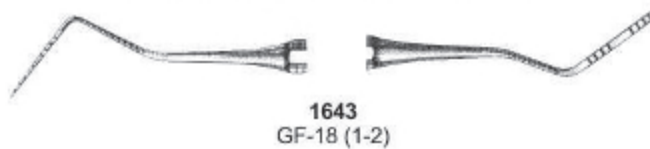

**Probes**

Probes Double Ended - Standard

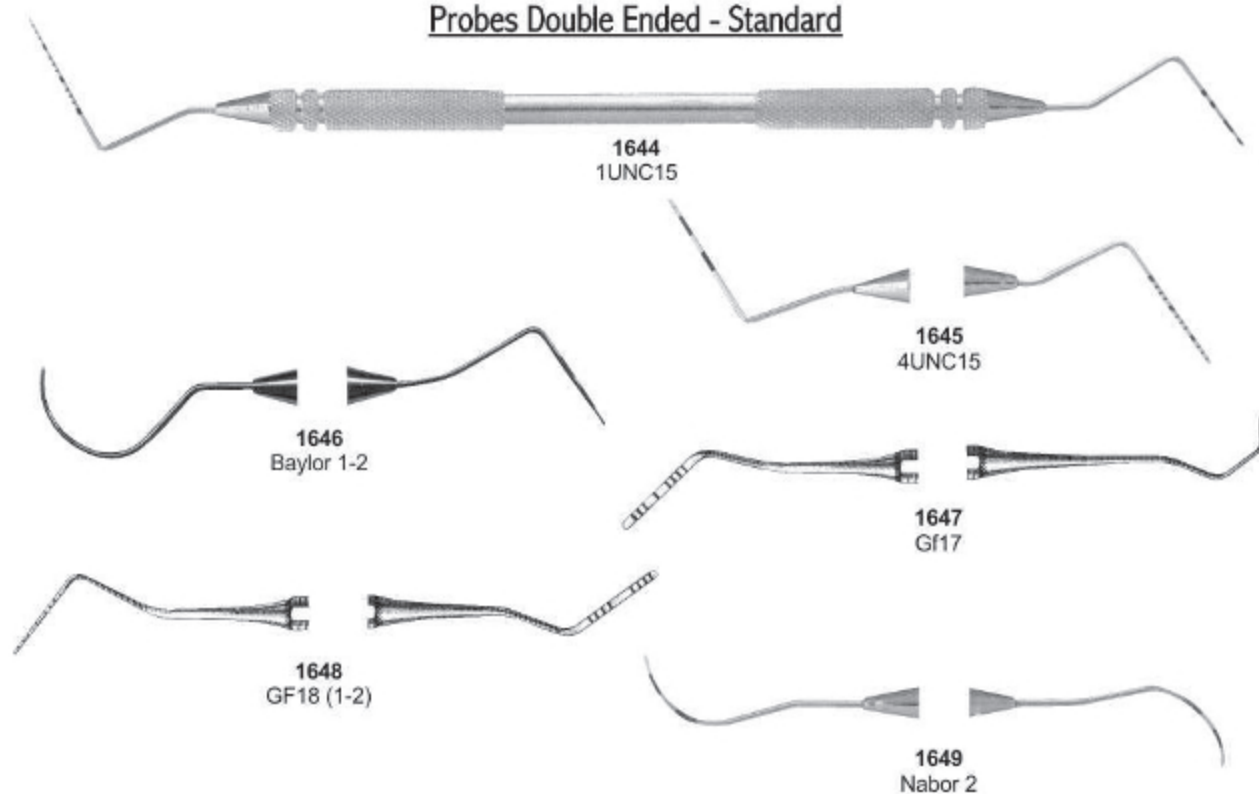

Probes Double Ended - Tactile Tone

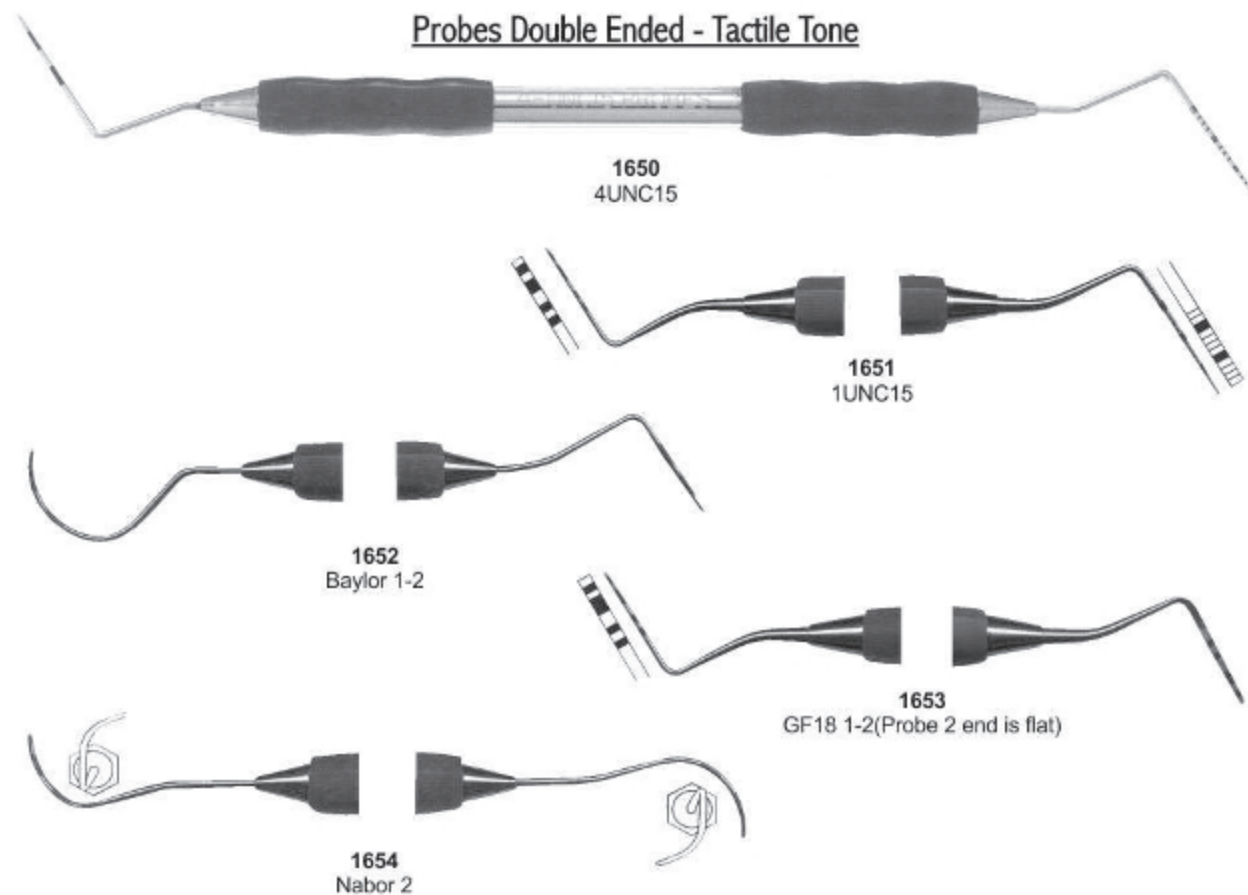

**Probes**

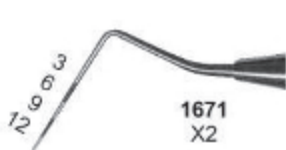
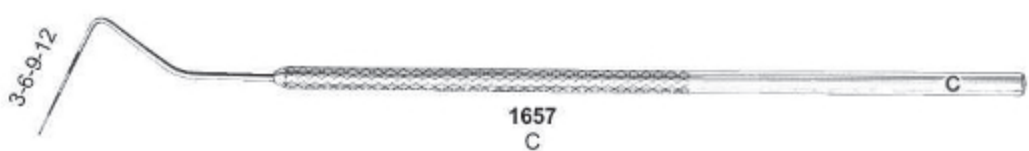
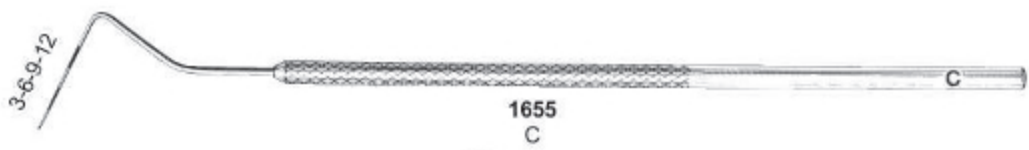

**Probes**

**PROBES DOUBLE ENDED STANDARD**

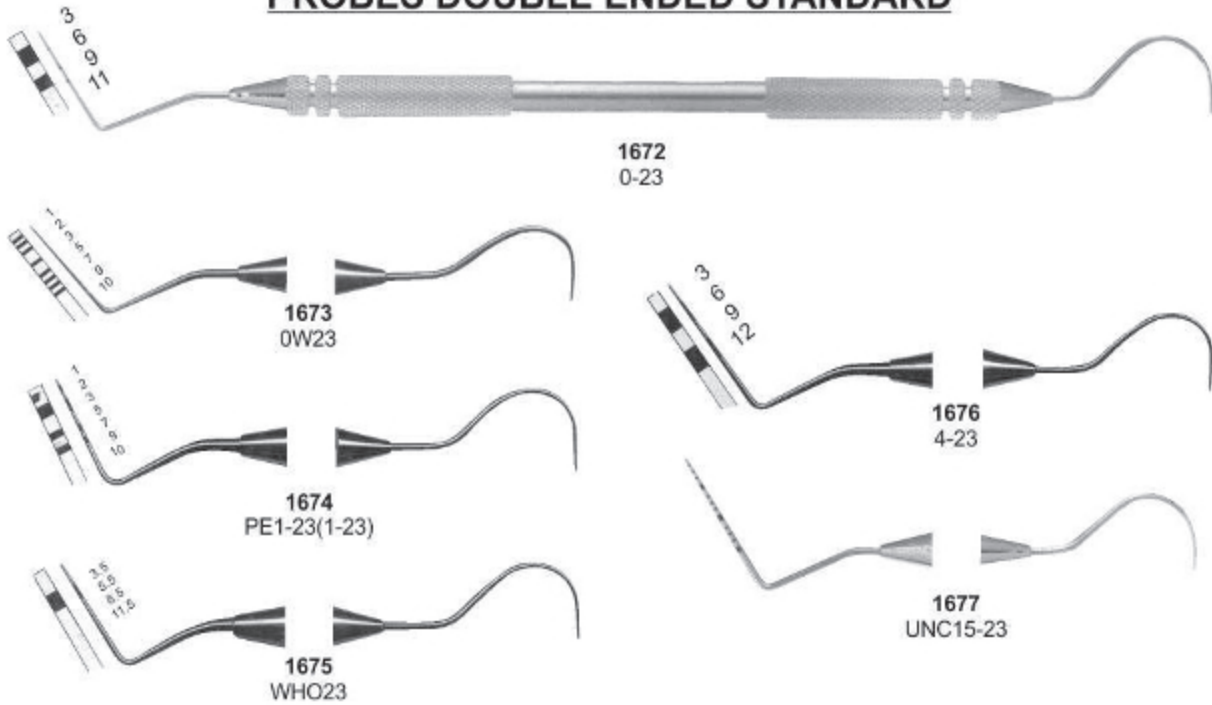

**PROBES DOUBLE ENDED TACTILE TONE**

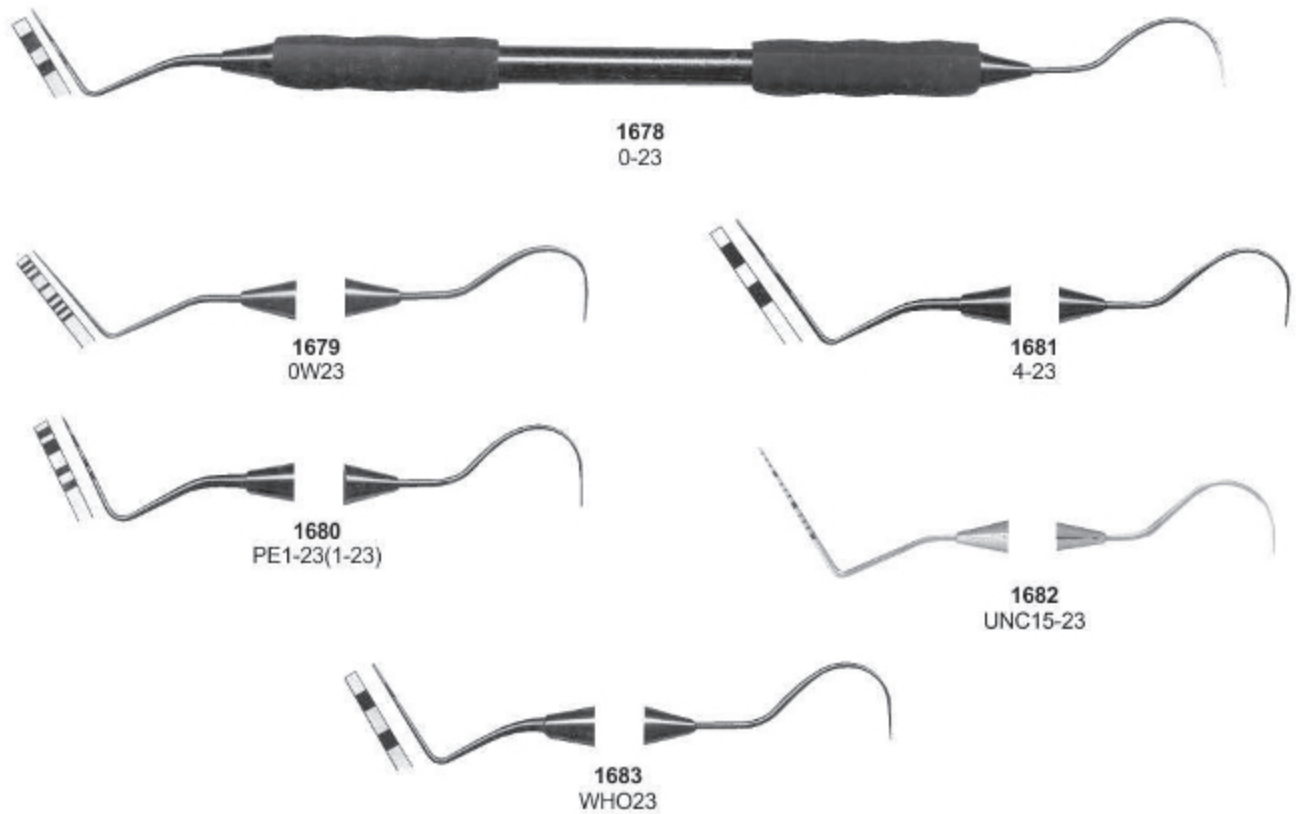



## Endodontic Condensers

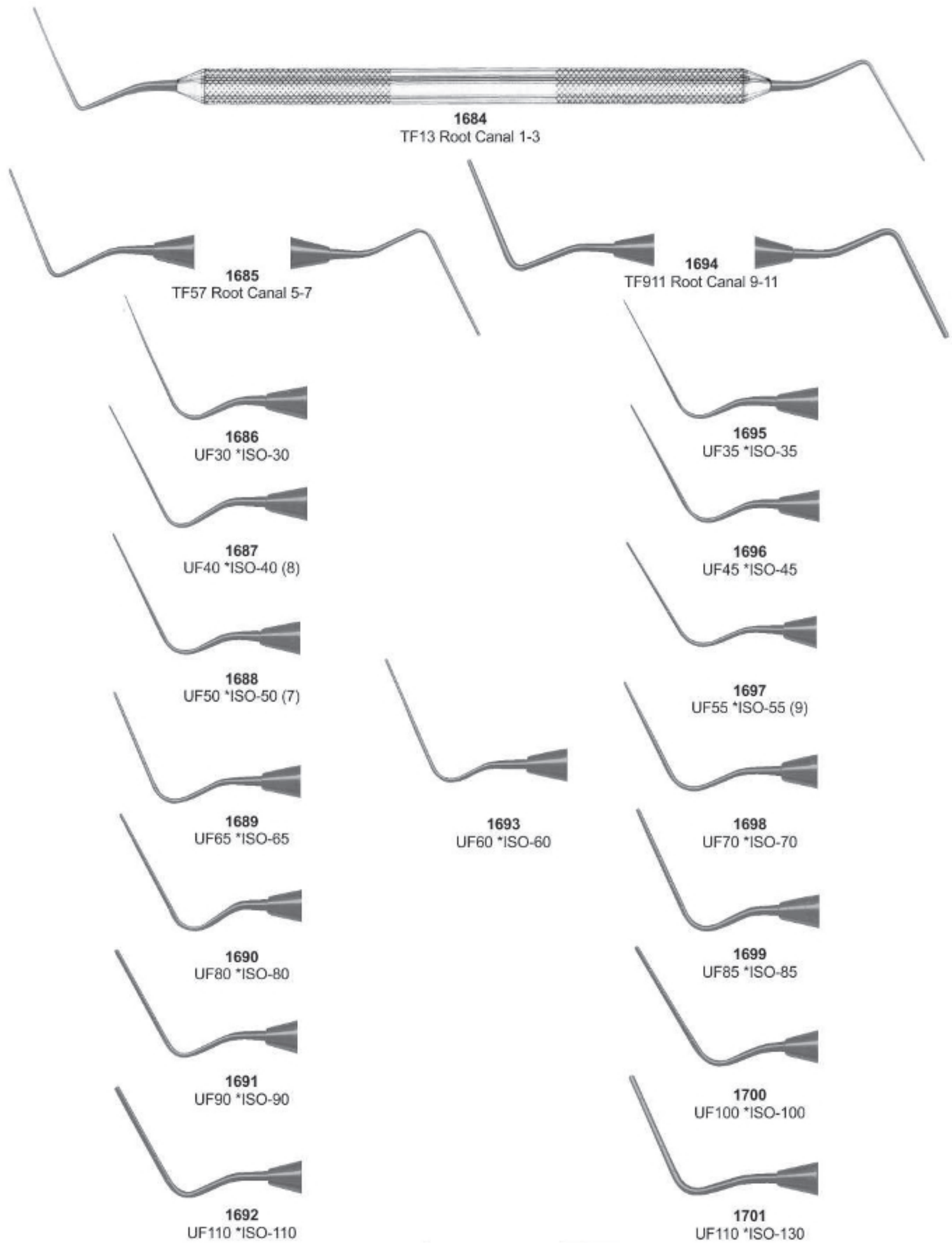

**Endodontic Condensers / Spreaders**

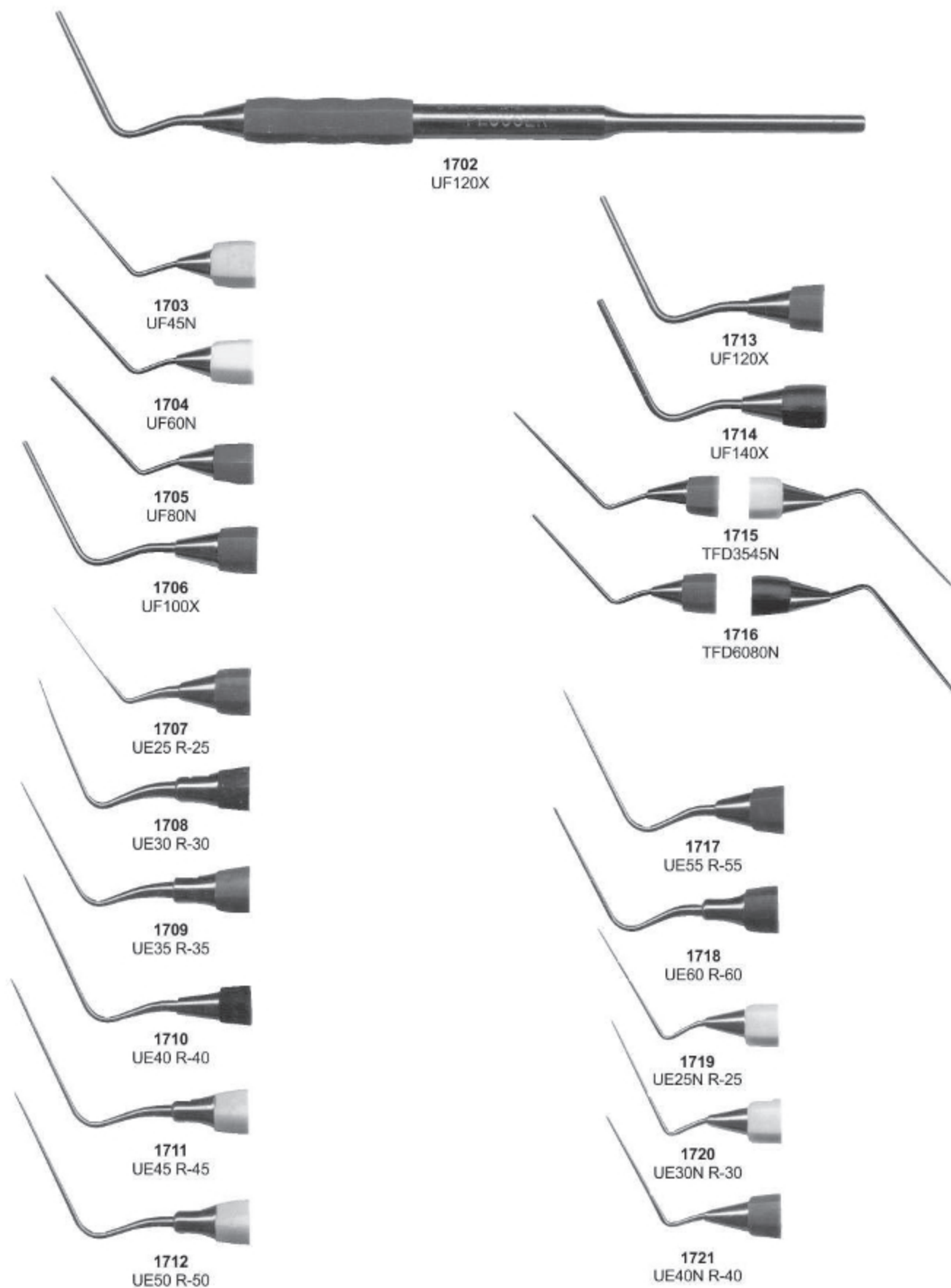

## Obturation Instruments

**1722**  
No. D11



**1723**  
No. D11T



**1724**  
No. KR1



**1725**  
No. 25S



**1726**  
No. W1S



**1727**  
No. W2S



**1732**  
No. 5, D(1mm).50mm, .55mm D(5mm)  
D(16mm), 85mm, .75mm D(16mm)

**1733**  
No. 7, D(1mm).70mm, .50mm D(5mm)  
D(16mm), 1.00mm, .75mm D(16mm)

**1734**  
No. 9, D(1mm)1.00mm, .63mm D(5mm)  
D(16mm), 1.30mm, .75mm D(16mm)

**1735**  
No. 11, D(1mm)1.20mm, .63mm D(5mm)  
D(16mm), 1.50mm, .75mm D(16mm)

**1736**  
No.1 (D1 .35mm, D16 .75mm)

**1737**  
No.2 D1 .55mm, D16 .85mm

**1738**  
No.3 D1 .85mm, D16 1.15mm

**1739**  
No.4 D1 1.00mm, D16 1.30mm

**1740**  
No.1-3 - D1 .25mm/D1 .35mm

**1741**  
No.3-5 - D1 .35mm/D1 .55mm

**1742**  
No.5-7 - D1 .55mm/D1 .70mm

**1743**  
No.9-11 - D1 1.00mm/D1 1.20mm

**Excavators**

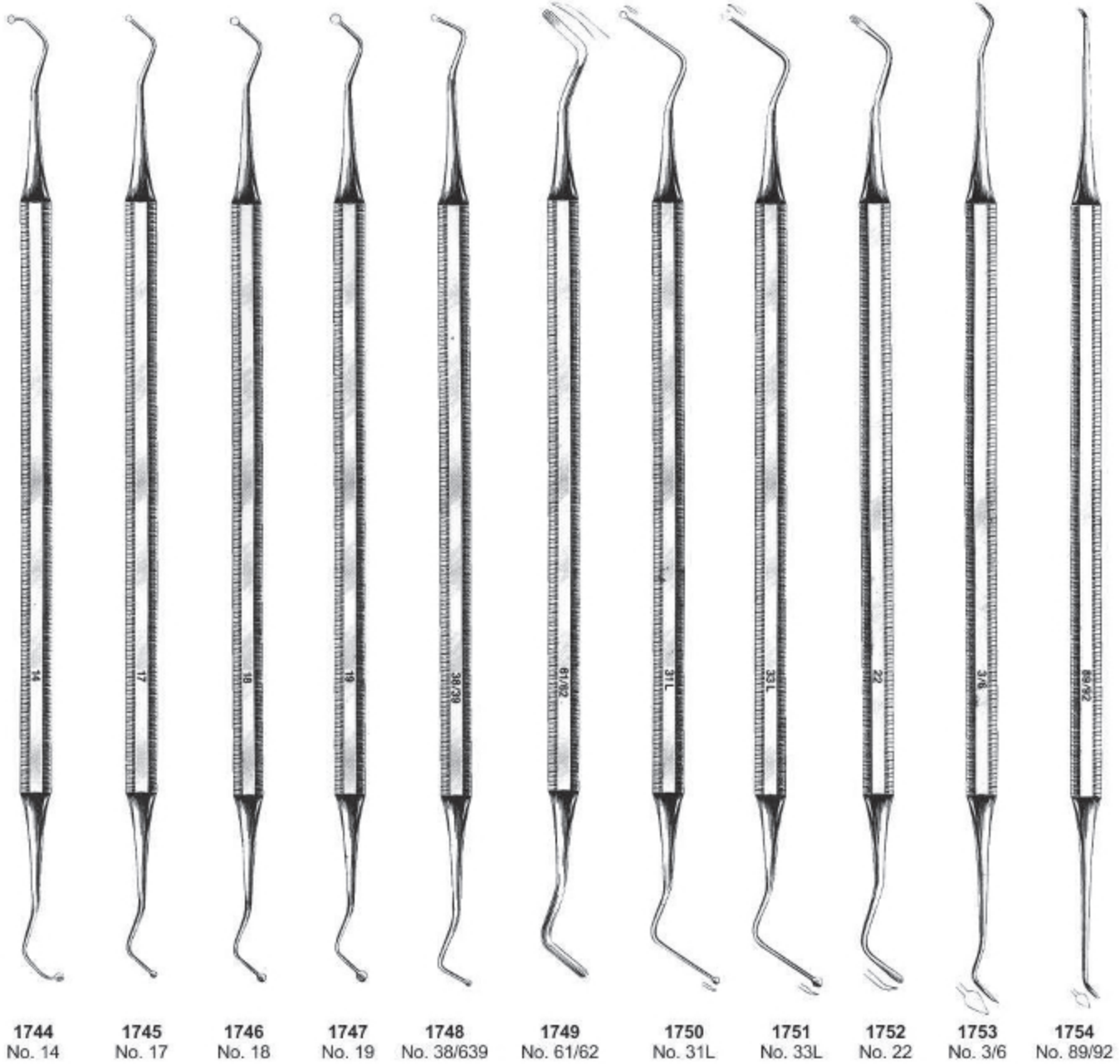

**1744**  
No. 14

**1745**  
No. 17

**1746**  
No. 18

**1747**  
No. 19

**1748**  
No. 38/39

**1749**  
No. 61/62

**1750**  
No. 31L

**1751**  
No. 33L

**1752**  
No. 22

**1753**  
No. 3/6

**1754**  
No. 89/92



## Excavators

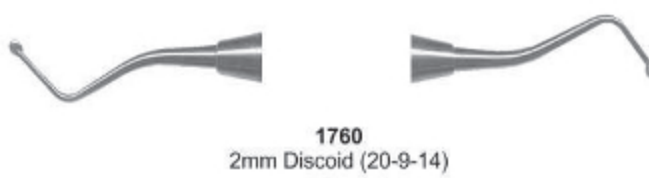

**Excavators, Explorer / Probes**

Excavators

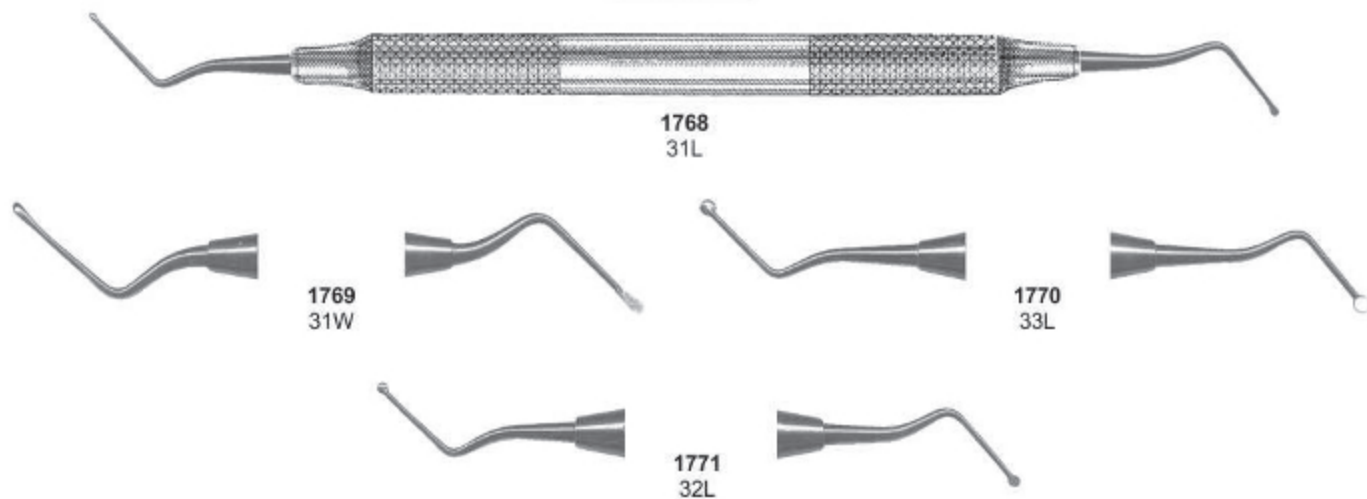

Explorers / Probes

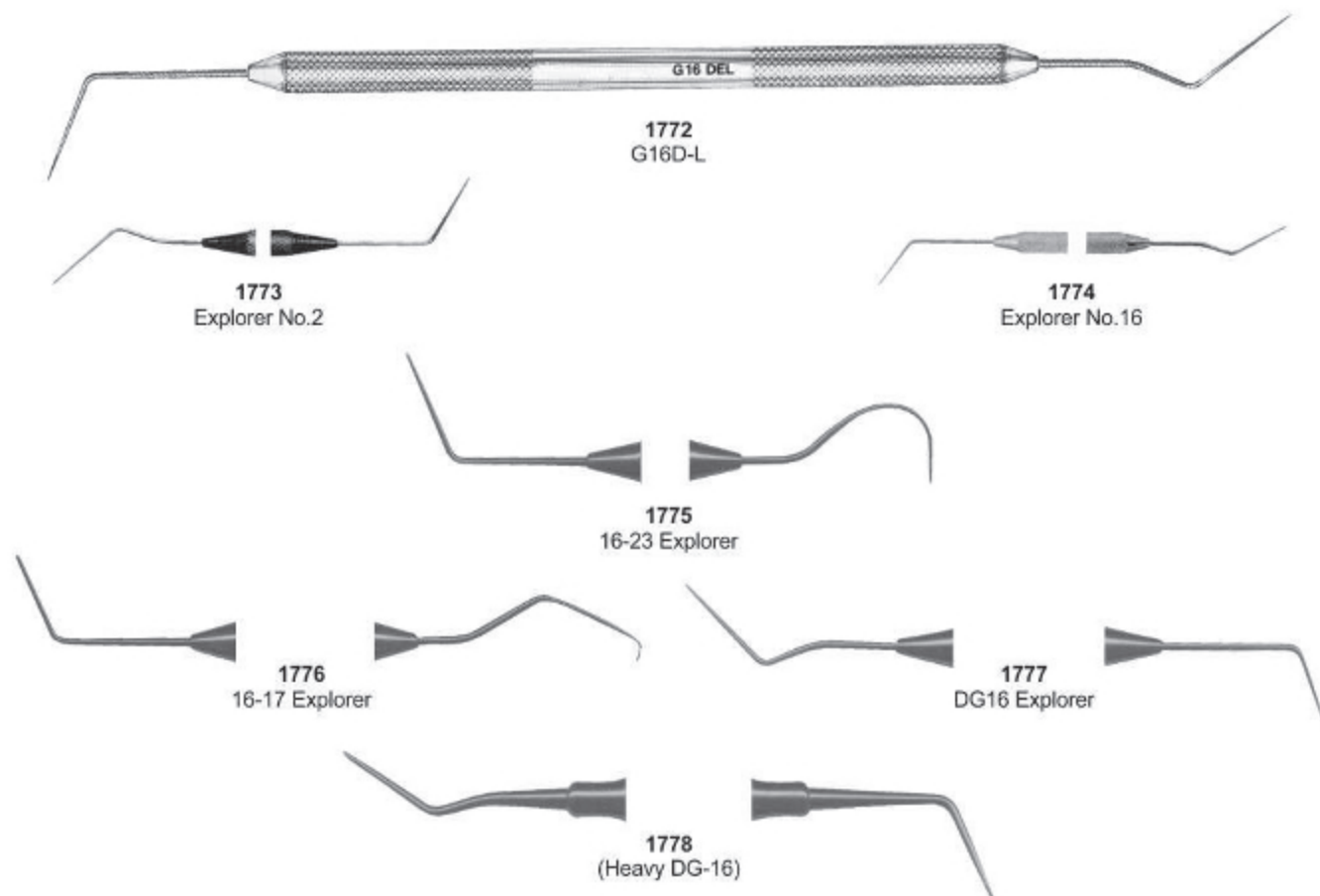

**Explorers**



**Explorers**

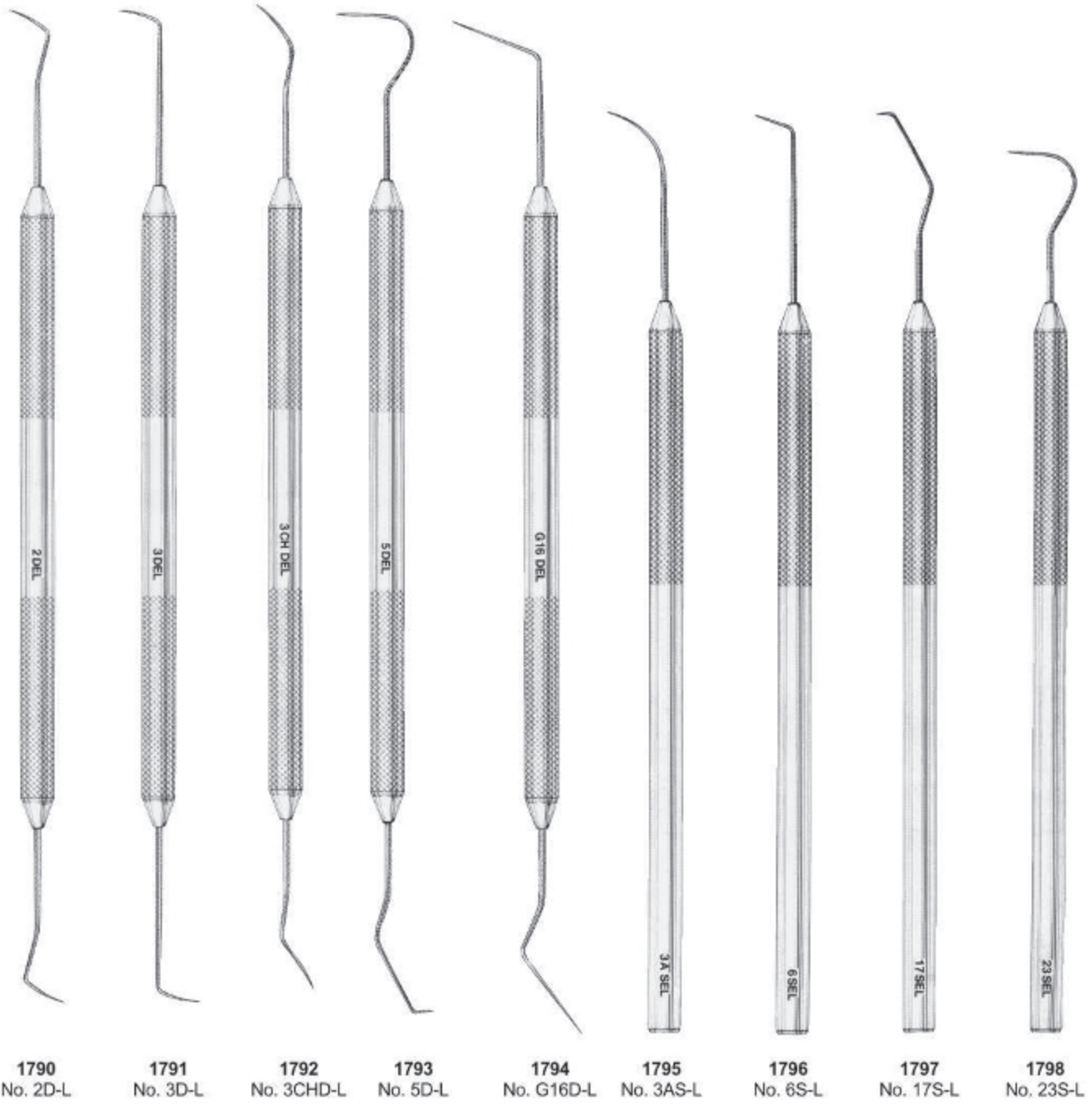



## Explorer / Probe Combination

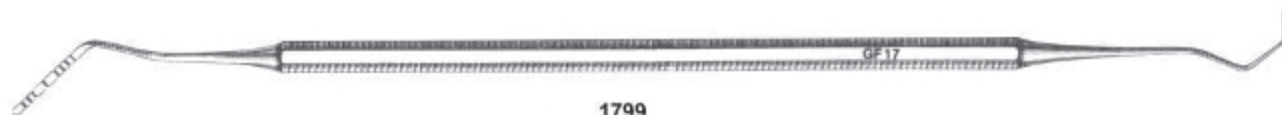

**1799**  
Gf17 Probe/Explorer



**1800**  
PE 1-23 Probe/Explorer

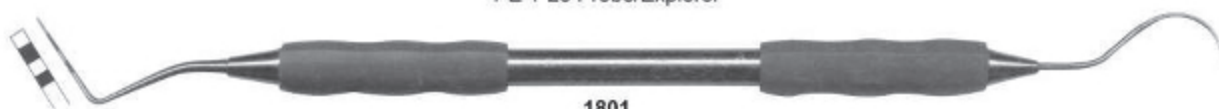

**1801**  
Probe 0 / 23 Explorer (fine)



**1802**  
Probe 1 / 23 Explorer



**1804**  
Probe 4 / 23 Explorer



**1803**  
Probe OW / 23 Explorer

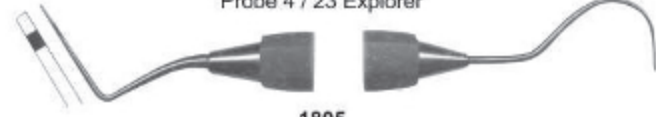

**1805**  
Ball Tip Probe WHO / 23 Explorer

## PROBES



**1806**  
Gf18 Probe



**1807**  
"C" Probe

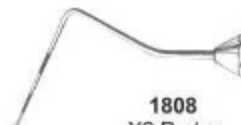

**1808**  
X2 Probe



**1809**  
1-2 (Probe 2 end is flat)



**1810**  
1 UNC 15



**1811**  
4 SE

**Cord Packers, Hatchets, Hoes**

CORD PACKERS



1812

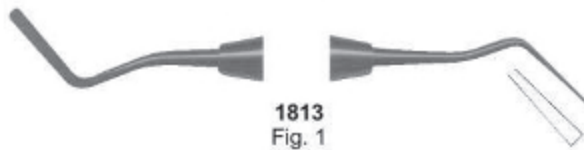

1813  
Fig. 1



1814  
Fig. 2



1815  
BLOOMFIELD  
Fig. 2 (off angle)



1816  
Fig. 1



1817  
CSI-1 (slightly serrated on ends)

HATCHETS



1818  
1mm (10-7-14)

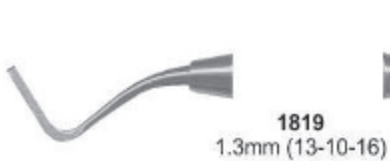

1819  
1.3mm (13-10-16)



1820  
1.5mm (15-8-14)

HOES

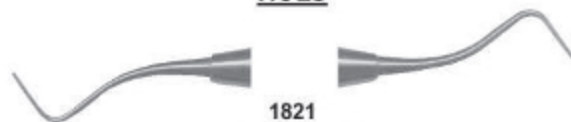

1821  
1mm (10-8-16)



1822  
UWH 18-19



1823  
UWH 16-18



1824  
UWH 20-21

**P.K.Thomas waxing & Gracey Currettes Set**



**1825**  
P.K.Thomas 1



**1826**  
P.K.Thomas 2



**1827**  
P.K.Thomas 3



**1828**  
P.K.Thomas 4

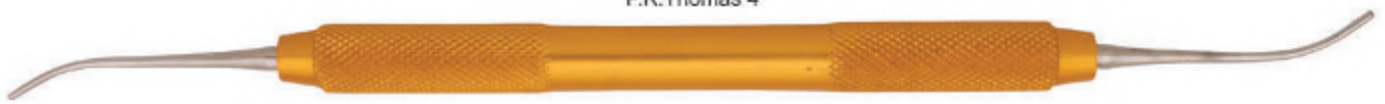

**1829**  
P.K.Thomas 5

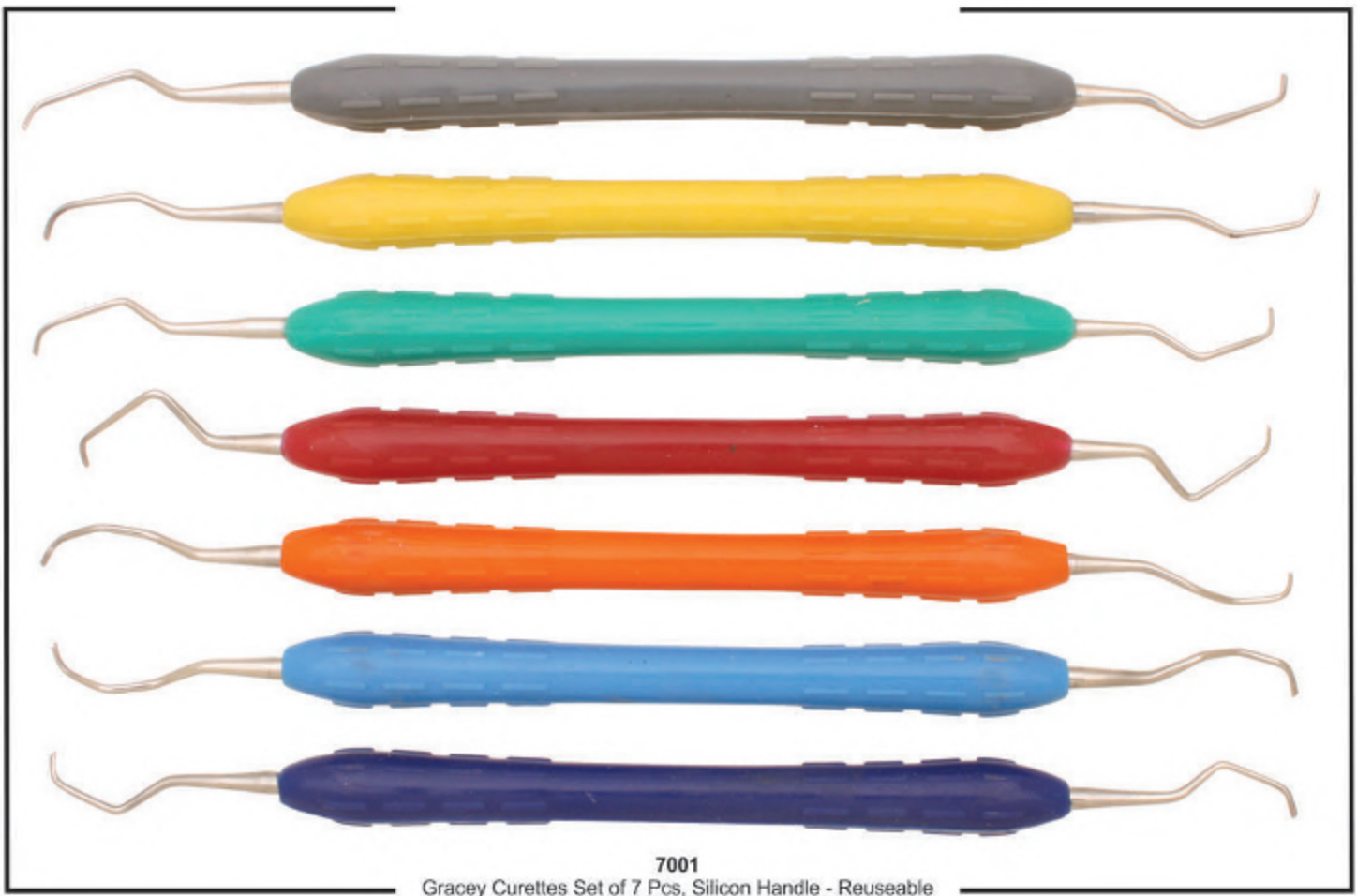

**7001**  
Gracey Currettes Set of 7 Pcs, Silicon Handle - Reuseable

## Amalgam Plugger / Condensers / Applicators



**1830**  
BEHRMAN (Fig. 1)



**1831**  
BLACK (Fig. 1-2)



**1832**  
MORQUETTE (Fig. 0/1)



**1833**  
Black Action 11/12 Plugger



**1834**  
Hollenback No. 1 Plugger



**1835**  
Hollenback No. 2 Plugger



**1836**  
Hollenback No. 3 Plugger



**1837**  
Blacks 0-1 (1mm-1.5mm)



**1838**  
Blacks 1-2 (1.5mm-2.5mm)



**1843**  
.7mm-1mm



**1839**  
Bodkin 1 (.7mm-1mm)



**1844**  
1mm-1.5mm

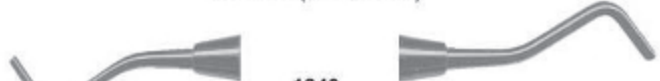

**1840**  
Bodkin 2 (1.5mm-2mm)



**1845**  
1.5mm-2mm



**1841**  
2.5mm-3mm



**1846**  
Oregon (Fig. 3)



**1842**  
Oregon 2



**1847**  
Oregon (Fig. 4)



**1848**  
UP 12



**1849**  
Applicator 1-2



**1850**  
Birtles Applicator Spatula



**1851**  
Birtles Applicator Spatula K



## Placement Instruments "Pluggers"

### Placement Instruments



### Stopping Stoppers



### Plugger



# SECTION 03



- ▶ Burnishers
- ▶ Chisels
- ▶ Filling Instruments
- ▶ Disposable Instruments
- ▶ Composite Placements
- ▶ Carvers
- ▶ Curettes



**Burnishers**



1864  
Fig. 1



1865  
Fig. 28/29



1866  
Fig. 34



1867  
Fig. 27/29



1868  
Fig. 21B



1869  
ACORN  
Fig. 21

**Burnishers**

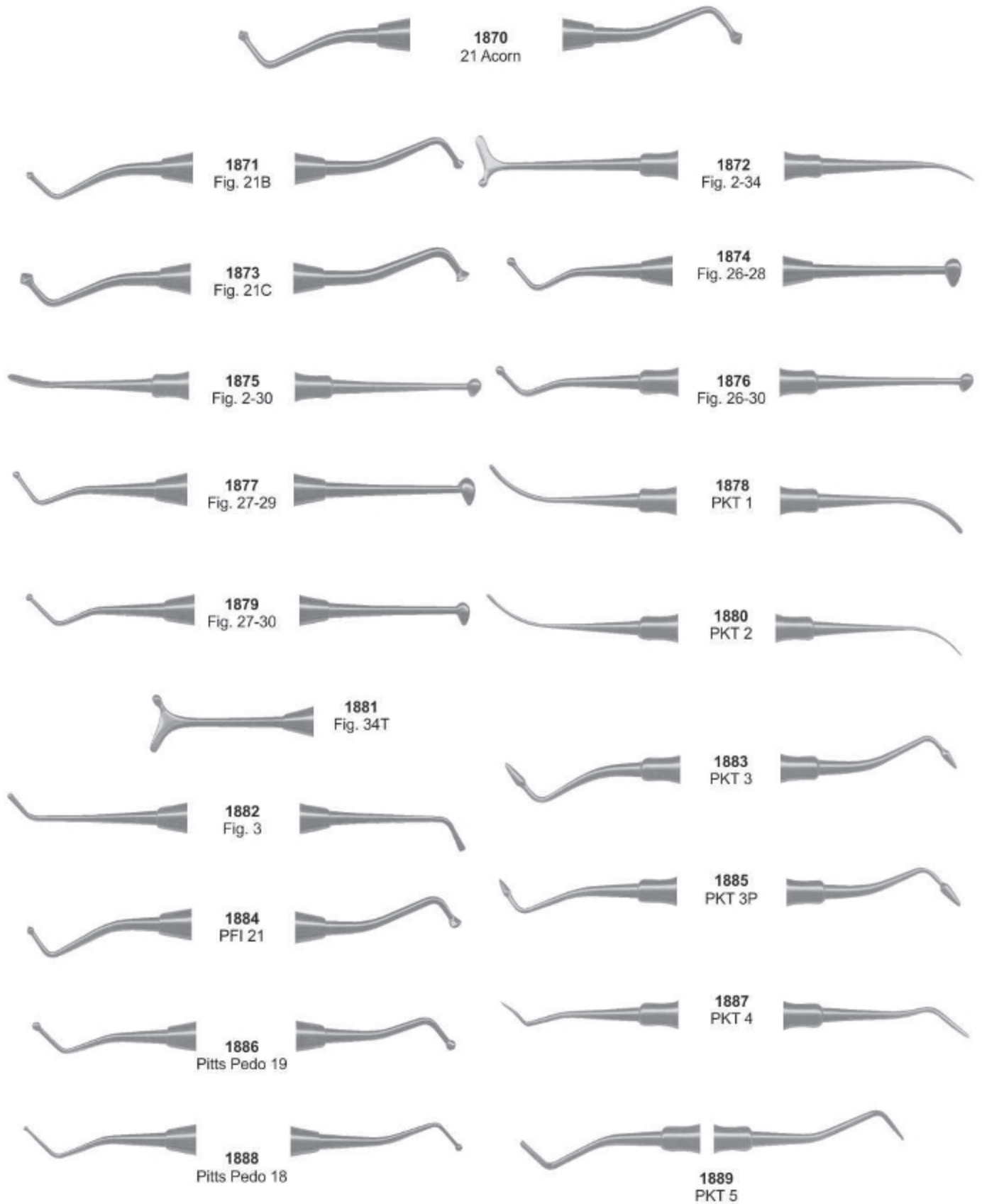



**Wax Carvers**



**1890**  
 HOLLENBACK  
 Fig. 3



**1891**  
 HOLLENBACK  
 Fig. 3S



**1892**  
 WARD 1  
 Fig. 1



**1893**  
 WARD 2  
 Fig. 2



**1894**  
 WALL 1  
 Fig. 1



**1895**  
 WALL 3  
 Fig. 3



**1896**  
 Fig. 3/6  
 Cleoid/Discoïd



**1897**  
 Fig. 89/92  
 Cleoid/Discoïd

## Carvers



**1898**  
1.5mm Cleoid Discoid (Shown with GTX Finish)



**1899**  
2mm Cleoid Discoid



**1900**  
GOLLOBIN  
Fig. 1



**1901**  
3mm Cleoid Discoid

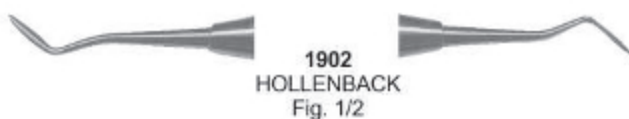

**1902**  
HOLLENBACK  
Fig. 1/2



**1903**  
FRAHM  
Fig. 2-3 (off-angle)

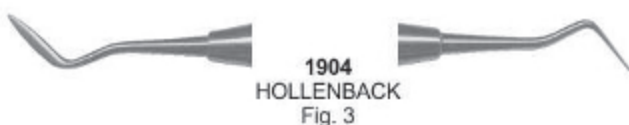

**1904**  
HOLLENBACK  
Fig. 3



**1905**  
Interproximal 1



**1906**  
THOMPSON (Fig. 3)  
( $\frac{1}{2}$  Hollenback Hoe & Wall 3)



**1907**  
Interproximal 1



**1908**  
THOMPSON (Fig. 5)  
( $\frac{1}{2}$  Hollenback Hoe & Tanner 5)



**1909**  
Baum Interproximal



**1910**  
THOMPSON (Fig. 8)  
(3mm Cleoid & Wall 3)



**1911**  
Sho A Carver



**1912**  
THOMPSON (Fig. 9)  
(Hollenback 3 & Wall 3)



**1913**  
Thompson 2



**1914**  
WARD  
Fig. 2

## Carvers, Chisels

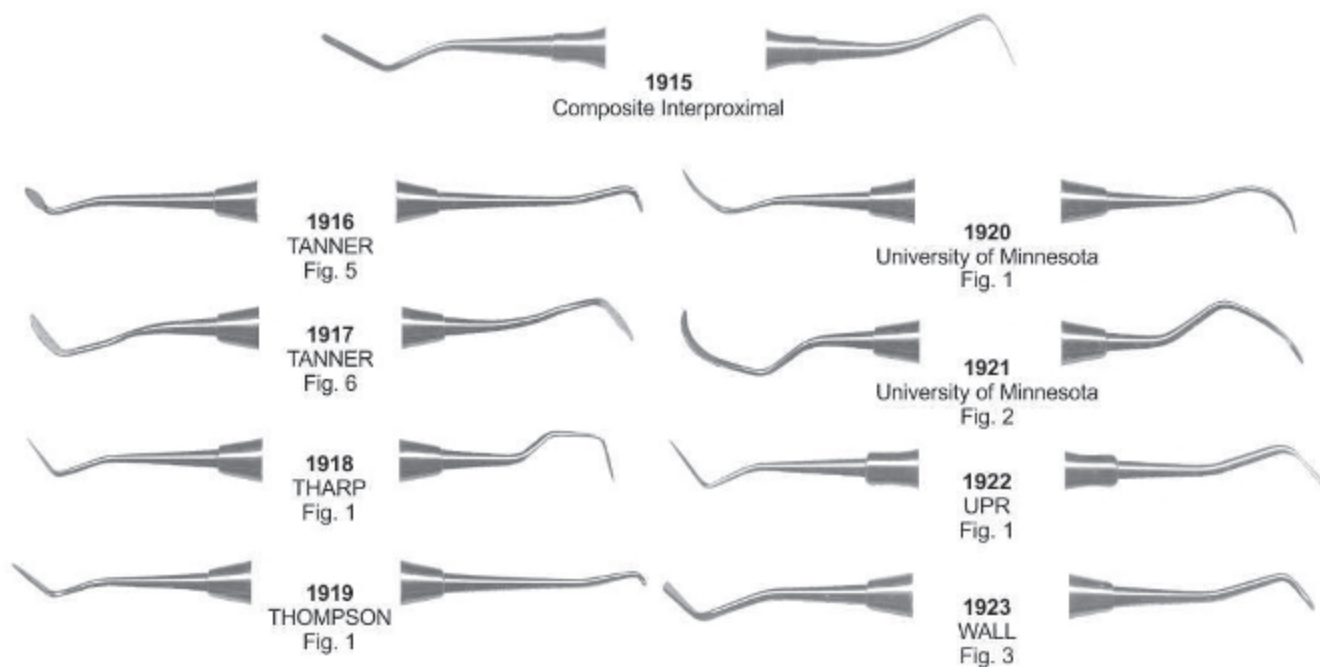

### Contour Carbide Carvers - Finishing

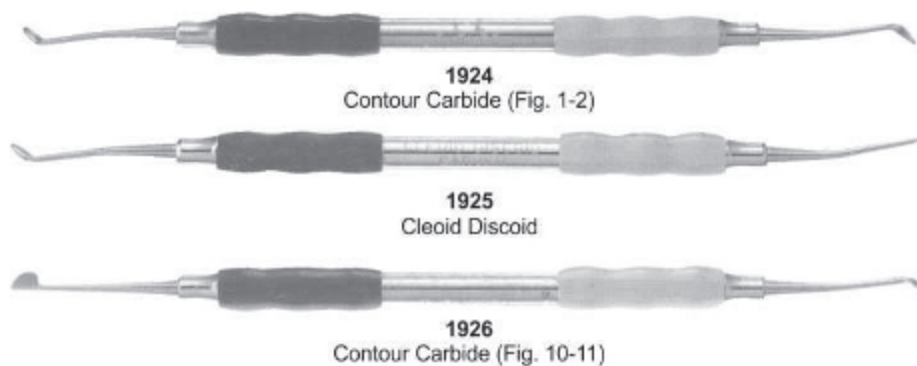

### Chisels

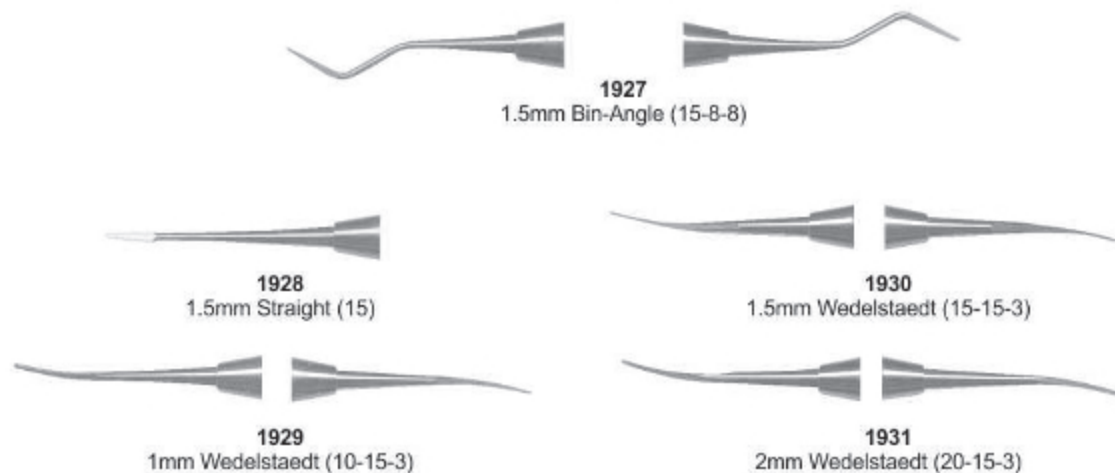

**Composite Placement**

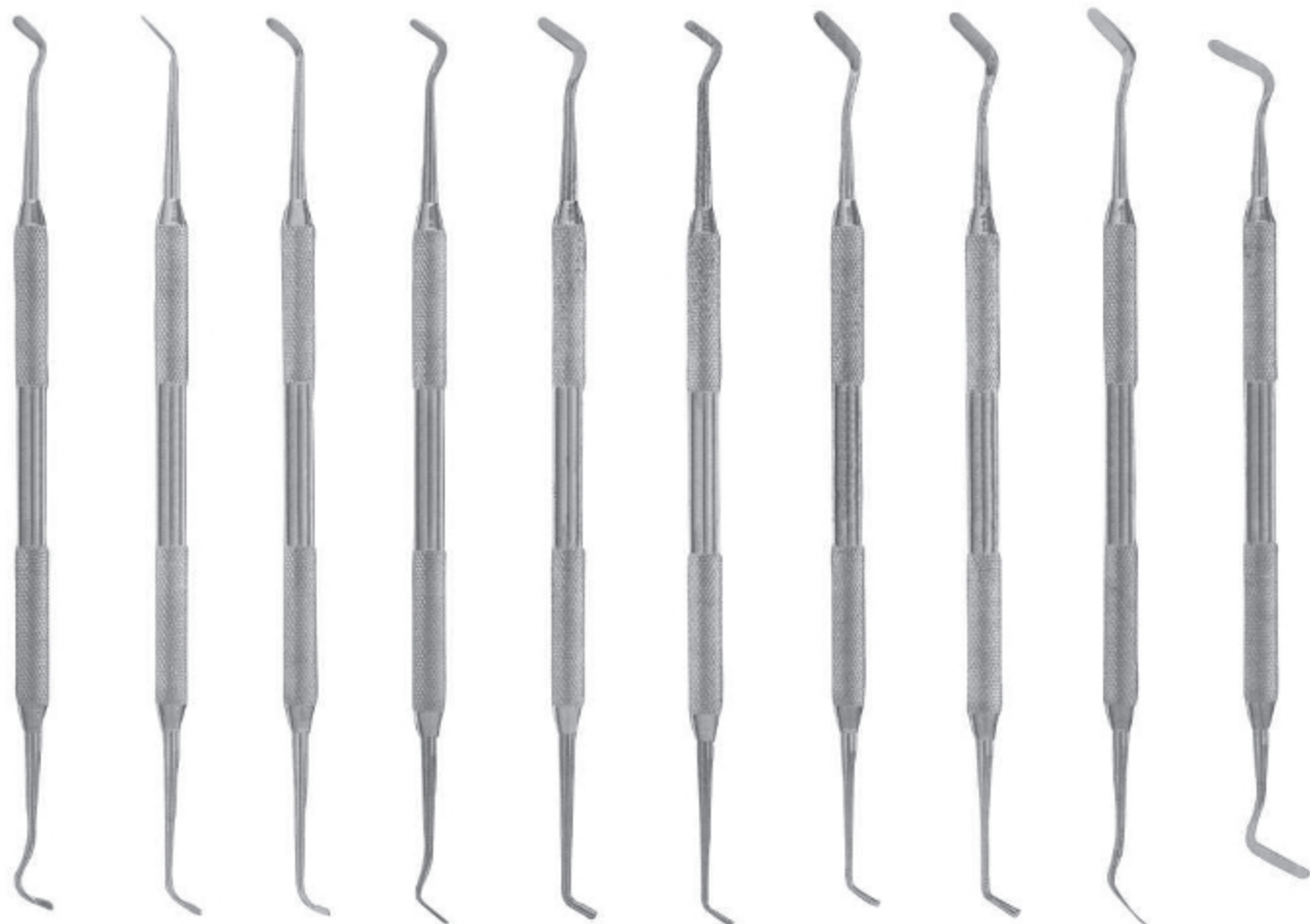

1932 F-Type 1    1933 F-Type 2    1934 F-Type 3    1935 F-Type 4    1936 F-Type 5    1937 F-Type 6    1938 G-Type 1    1939 G-Type 2    1940 G-Type 3    1941 G-Type 4

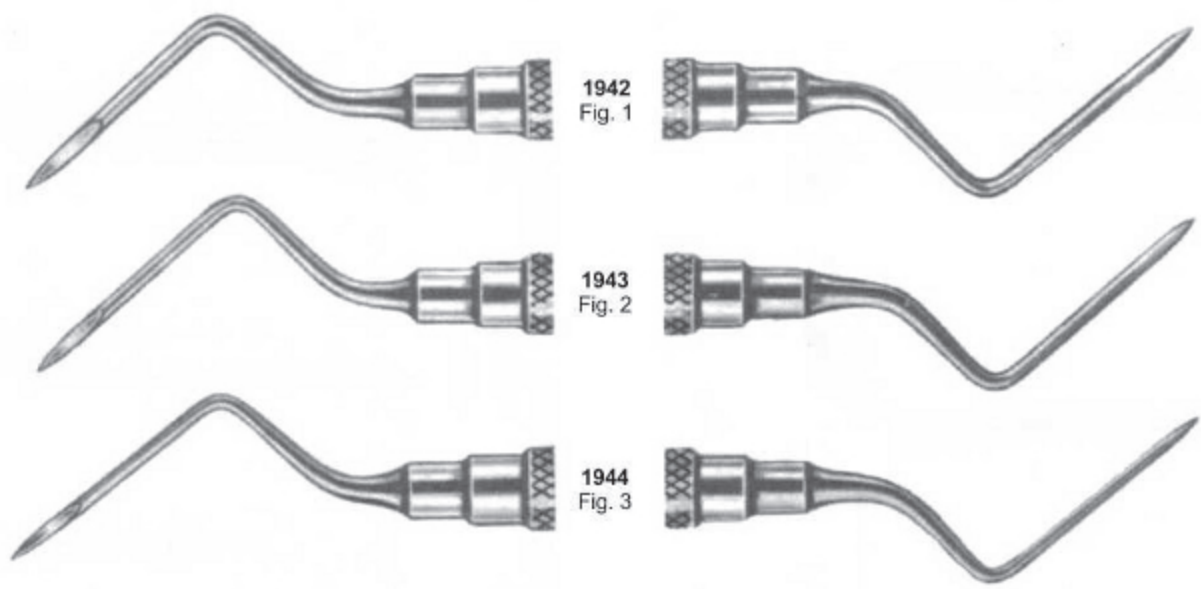

1942  
Fig. 1

1943  
Fig. 2

1944  
Fig. 3



**Composite Placement**



1945  
Fig. 2



1946  
Fig. 3 (off-set blade)



1954  
Fig.12



1947  
Fig. 4



1955  
Fig.15



1948  
Fig. 5



1956  
JORDAN  
Fig. 2



1949  
Fig. 6



1957  
FREEDMAN  
Fig. 1



1950  
Fig.7



1958  
FREEDMAN  
Fig. 2



1951  
Fig.8



1959  
FREEDMAN  
Fig. 3



1952  
Fig.9



1960  
Dr. Dan



1953  
Fig.11



1961  
SIMON  
Fig. 2



**K - Type**

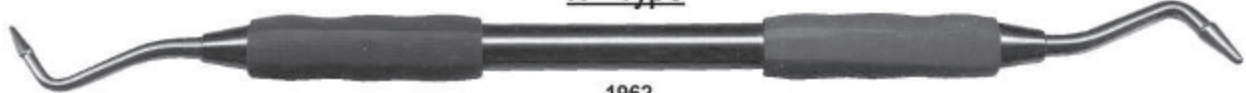

1962  
K-Type 1



1963  
K-Type 2



1965  
K-Type 4



1964  
K-Type 3



1966  
K-Type 5



1967  
K-Type 6 Carbide

**Plastic Filling Instruments**



## Plastic Filling Instruments



1977  
 Fig. 5-7



1978  
 Fig.1



1979  
 Fig. 3



1983  
 GLICK  
 Fig.1



1980  
 Fig. 4



1984  
 P8



1981  
 Fig. 5-7



1985  
 WOODSON  
 Fig. 1



1982  
 Fig. 8A



1986  
 WOODSON  
 Fig. 2



1987  
 WOODSON  
 Fig. 3



## Curettes



1988  
GRACEY  
GC 1-2



1989  
GRACEY  
GC 3-4



1990  
GRACEY  
GC 5-6



1991  
GRACEY  
GC 7-8



1992  
GRACEY  
GC 9-10



1993  
GRACEY  
GC 11-12



1994  
GRACEY  
GC 13-14



## Gracey Currettes



1995  
G1-2



1996  
G3-4



1997  
G5-6



1998  
G7-8



1999  
G9-10



2000  
G11-12

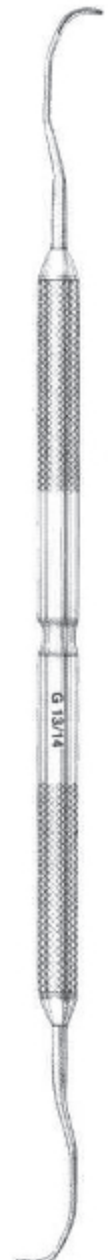

2001  
G13-14

**Curettes # 4 Handle**

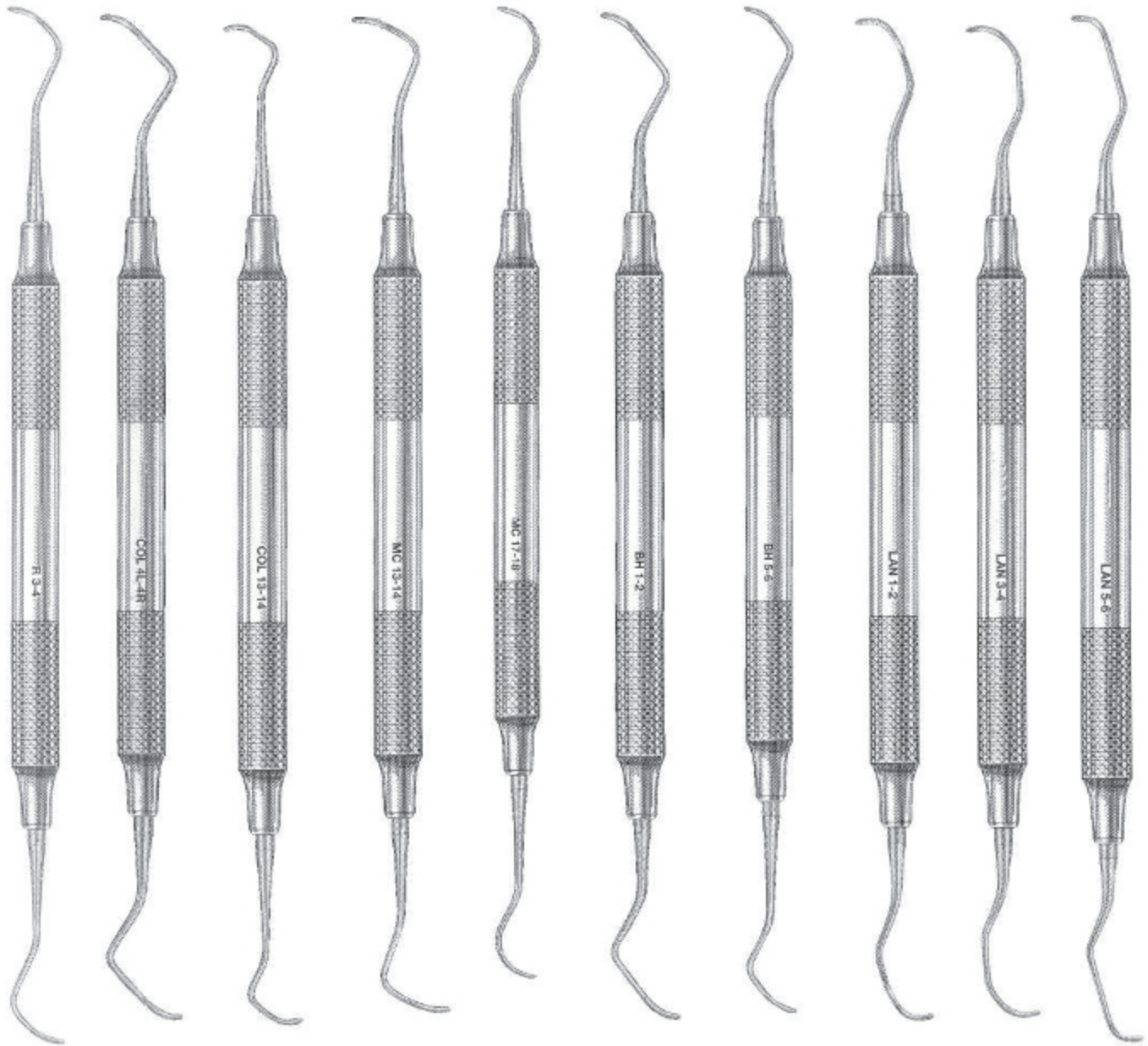

**2002**  
**RULE**  
 3-4

**2003**  
**COLUMBIA**  
 4R-4L

**2004**  
**COLUMBIA**  
 13-14

**2005**  
**MCCALLS**  
 13-14

**2006**  
**MCCALLS**  
 17-18

**2007**  
**BARNHART**  
 1-2

**2008**  
**BARNHART**  
 5-6

**2009**  
**LANGER**  
 1-2

**2010**  
**LANGER**  
 3-4

**2011**  
**LANGER**  
 5-6

**Curettes**

COLUMBIA CURETTES



2012  
4L-4R

2013  
13-14

2014  
2L-2R

MCCALLS CURETTES



2015  
13-14

2016  
13S-14S

2017  
17-18

2018  
17S-18S

**Curettes**

**GOLDMAN FOX**



**2019**  
GF1 Universal Scaler



**2020**  
GF2 Curette



**2021**  
GF3 Curette



**2022**  
GF4 Curette



**2023**  
GF5 Hoe



**2024**  
GF6 Hoe



**Curettes**

**GOLDMAN FOX**



**2025**  
GF 7 Knife



**2026**  
GF 8 Spear Knife



**2027**  
GF 9 Knife Scaler



**2028**  
GF 11 Spear Knife



**2029**  
GF 21 Sharp Spoon /  
Small Scaler

## Knives, Interproximal Files



2030  
Kirkland 15 / 16



2031  
Ordan 1 / 2



2032  
Buck 3 / 4

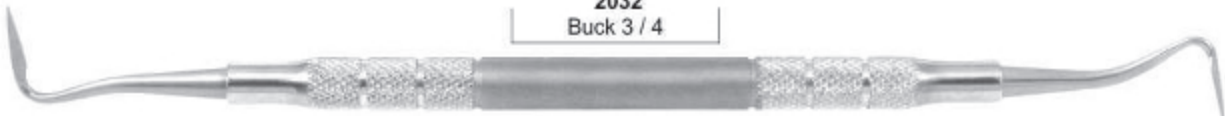

2033  
Buck 5 / 6



2034  
Goldman-Fox 7



2035  
Goldman-Fox 8



2036  
Goldman-Fox 9



2037  
Goldman-Fox 11



2038  
CK 3 (Crane)

### Interproximal Files



2039  
Sugarman 1S-2S

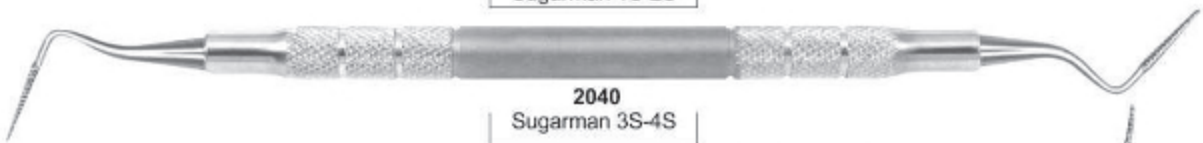

2040  
Sugarman 3S-4S



2041  
Schluger 9 -10



2042  
Buck 11 - 12

## Curettes, Root Planing Curettes



**2043**  
 COLUMBIA (2L-2R)



**2044**  
 MCCALL (13-14)



**2045**  
 MCCALL (17S-18S)

### Root Planing Curettes



**2046**  
 Root Plane (1-2)



**2047**  
 Root Plane (5-6)



**2049**  
 Root Plane (11-12)



**2048**  
 Root Plane (7-8)



**2050**  
 Root Plane (13-14)

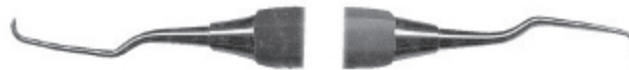

**2051**  
 Petite (1-2)



**2052**  
 Petite (11-12)



**2053**  
 Petite (5-6)



**2054**  
 Petite (13-14)

## Curettes



**2055**  
BARNHART (1-2)



**2056**  
BARNHART (5-6)



**2065**  
COLUMBIA (4L-4R)



**2057**  
GRACEY (1-2)



**2066**  
COLUMBIA (13-14)



**2058**  
GRACEY (3-4)



**2067**  
LANGER (1-2)



**2059**  
GRACEY (5-6)



**2068**  
LANGER (3-4)



**2060**  
GRACEY (7-8)



**2069**  
LANGER (5-6)



**2061**  
GRACEY (9-10)



**2070**  
MCCALL (13-14)



**2062**  
GRACEY (11-12)



**2071**  
MCCALL (13S-14S)



**2063**  
GRACEY (13-14)



**2072**  
MCCALL (17-18)



**2064**  
GRACEY (2L-2R)



**2073**  
MCCALL (17S-18S)



**2074**  
RULE (3-4)



**Dental Products**

Silicon Handles-Reusable

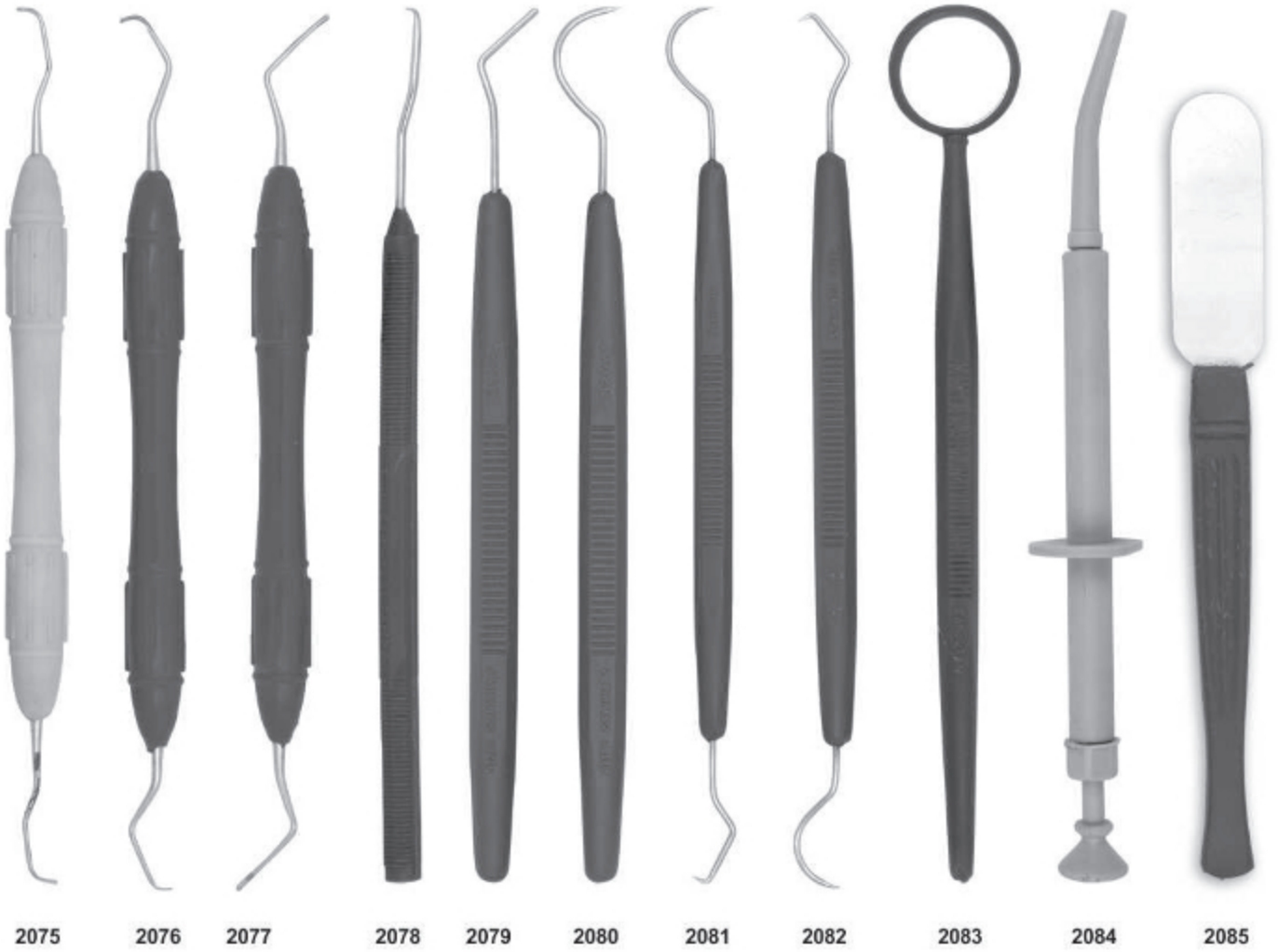

# SECTION 04

**SEASONED**  
*Take away the Beauty*  
Since 1985

- ▶ Cement Instruments
- ▶ Spatulas
- ▶ Knives
- ▶ Bone Currettes & Files
- ▶ Bone Chisels
- ▶ Bone Mallets
- ▶ Crown Remover
- ▶ Implant Instruments



**Wax, Porcelain & Cement Instruments**

Comfort Grip  
Vinyl - Covered Insulating Handles



2091 ROACH-A    2092 ROACH-B    2093 LECRON 5-A    2094 LECRON 5-B    2095 VEHE-A    2096 VEHE-B    2097 A7    2098 B7    2099 WARD 2-A    2100 WARD 2-B



**Wax, Porcelain & Cement Instruments**

P.K. THOMAS

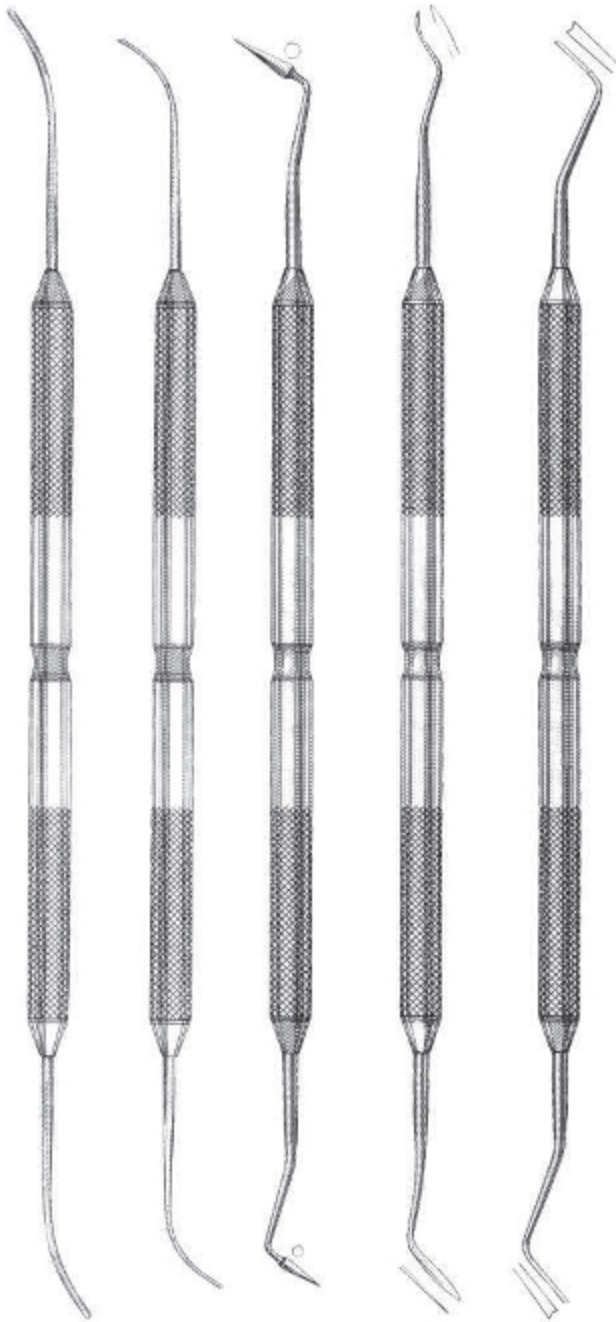

2101 PKT 1    2102 PKT 2    2103 PKT 3    2104 PKT 4    2105 PKT 5

Set of 5 instruments

WAX CARVERS

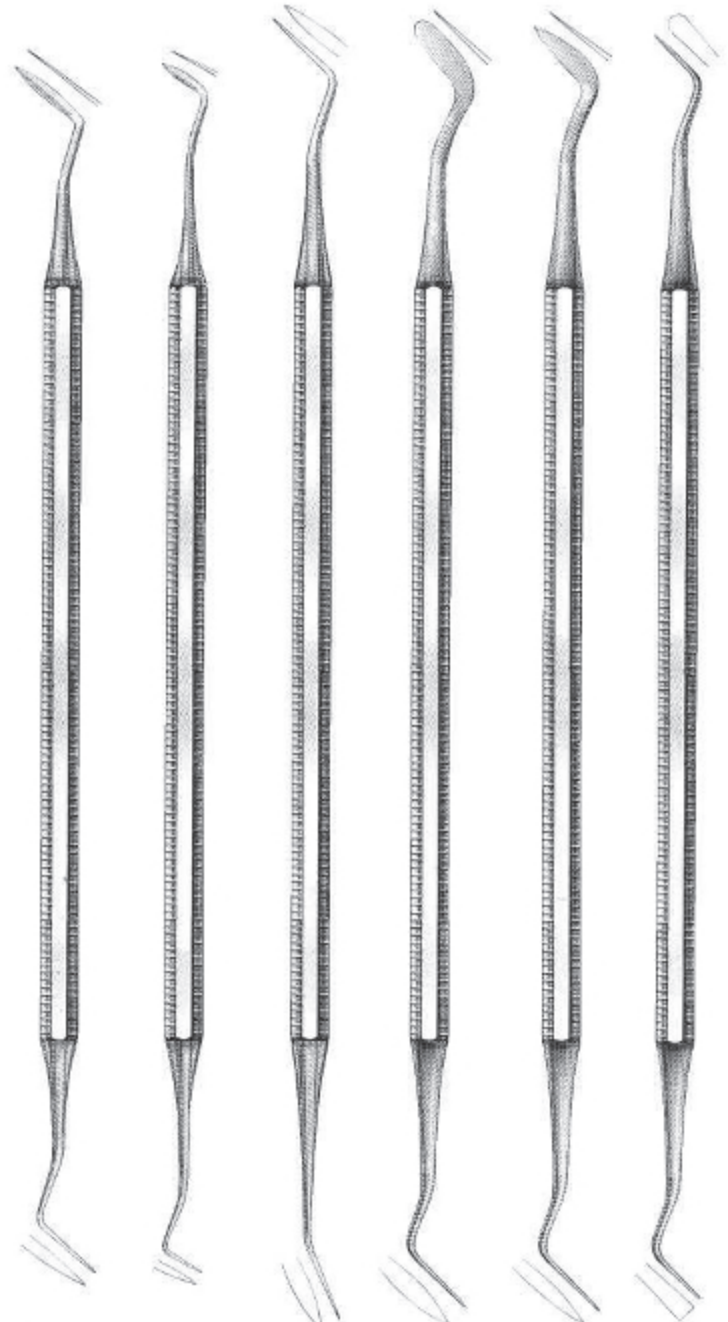

2106 Hollenback 3    2107 Hollenback 3S    2108 WARD 1    2109 WARD 2    2110 WALL 1    2111 WALL 3



**Wax & Modelling Carvers, Cement Spatulas**

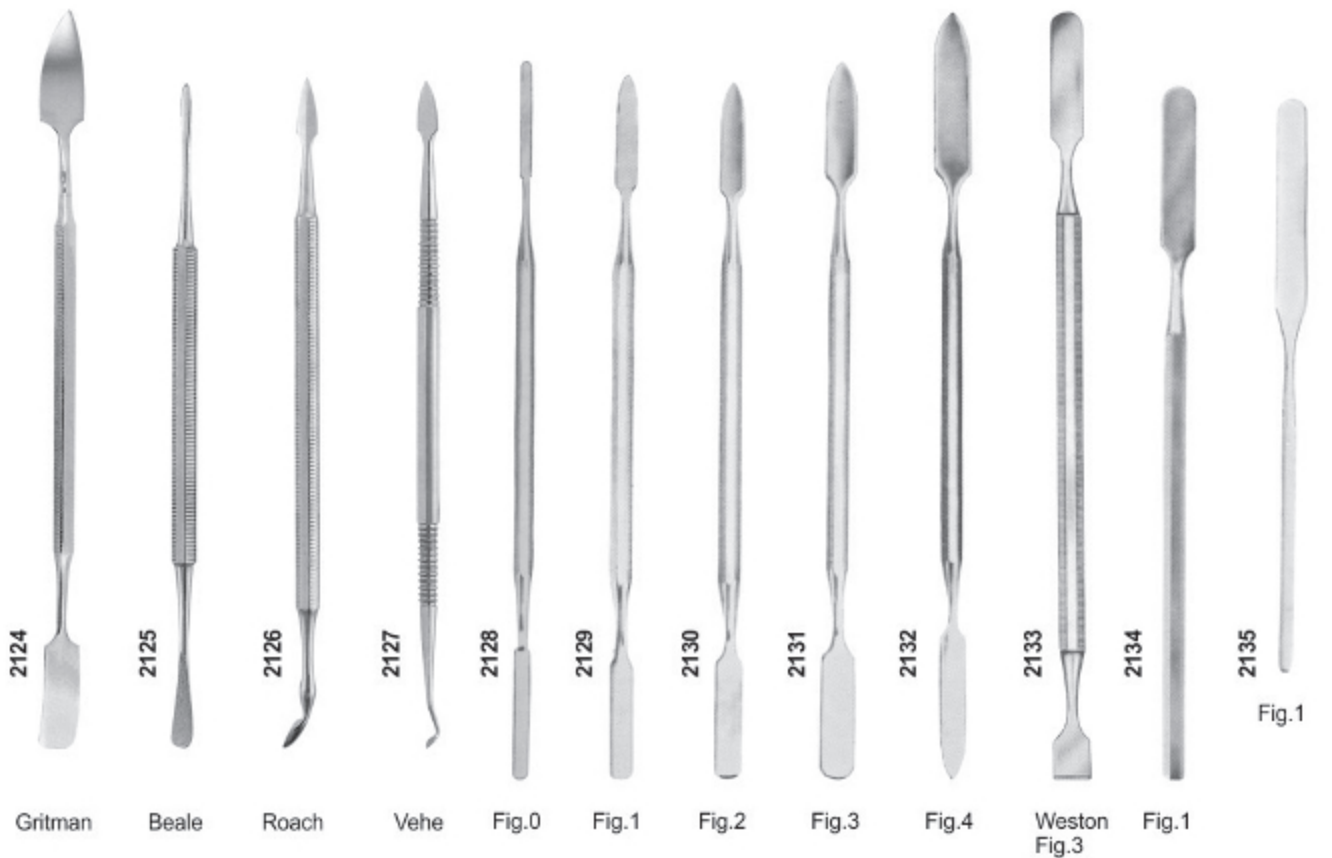
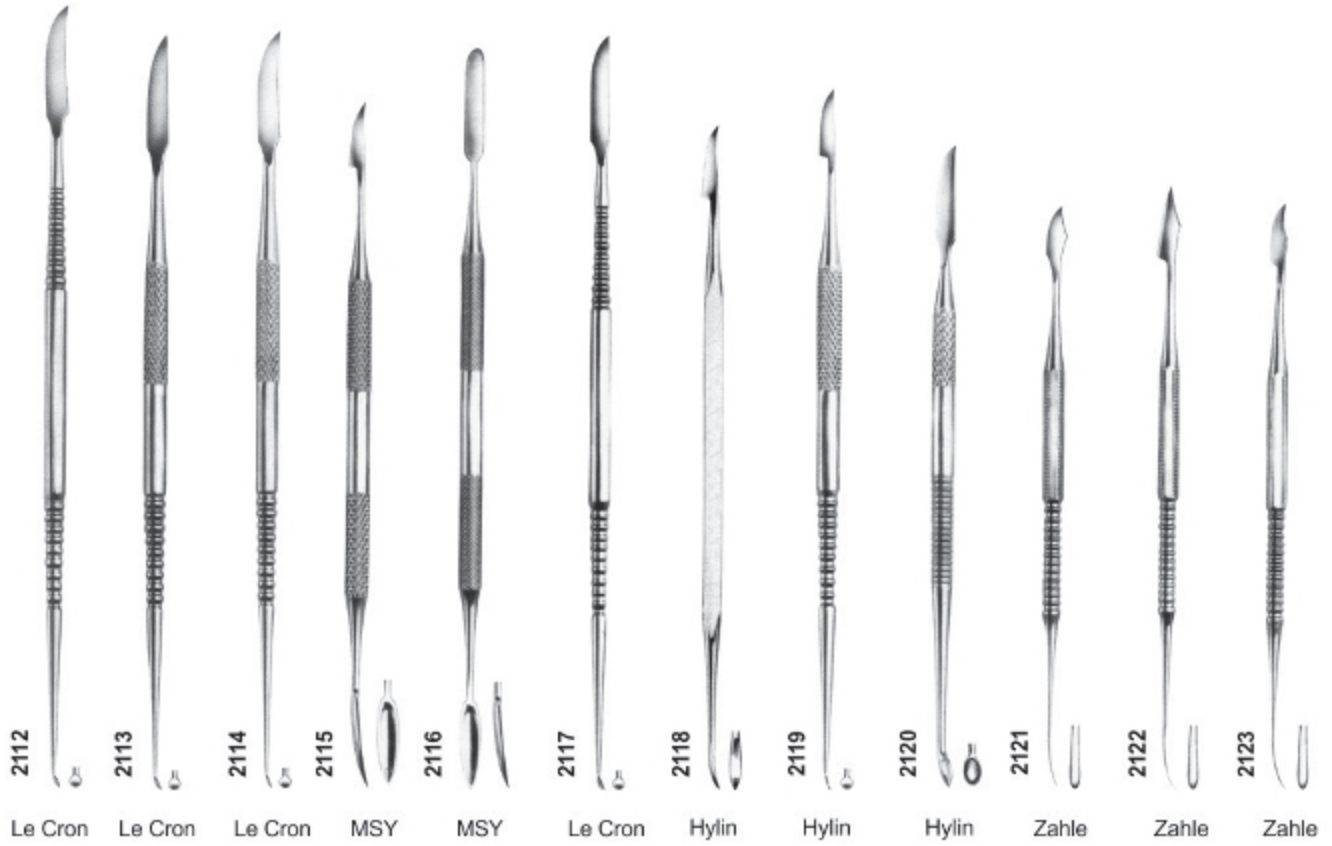

**Wax, Porcelain & Cement Instruments**

WAX & PORCELAINE CARVERS

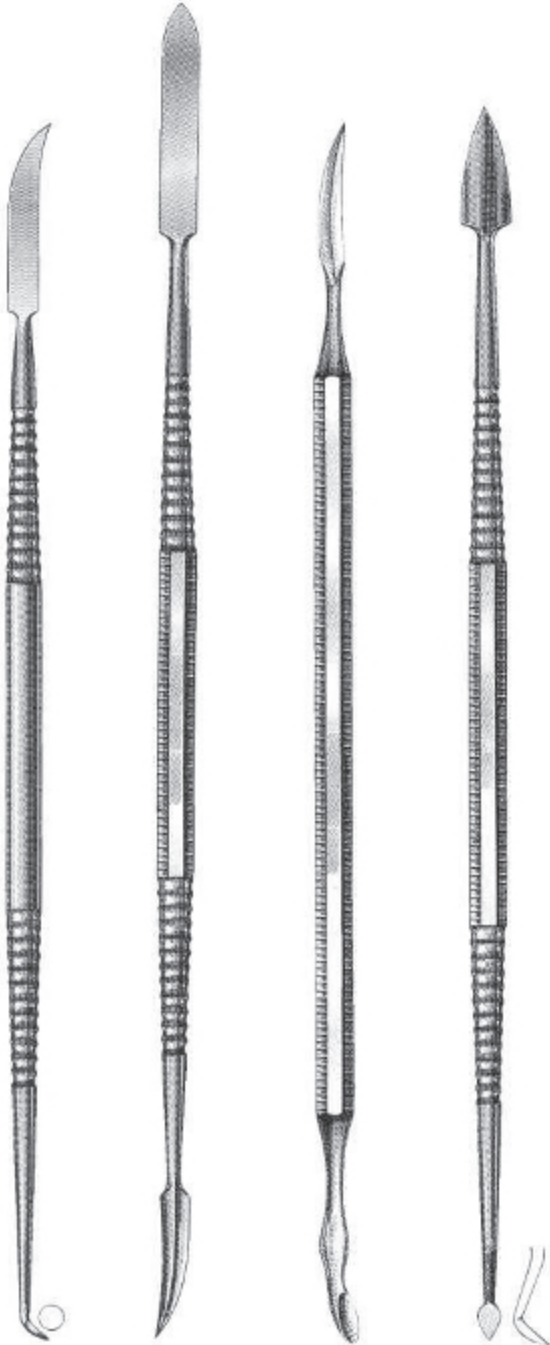

2136  
LECRON  
Inlay

2137  
REEVES

2138  
VEHE  
Wax

2139  
ROACH  
Wax

WAX SPATULAS

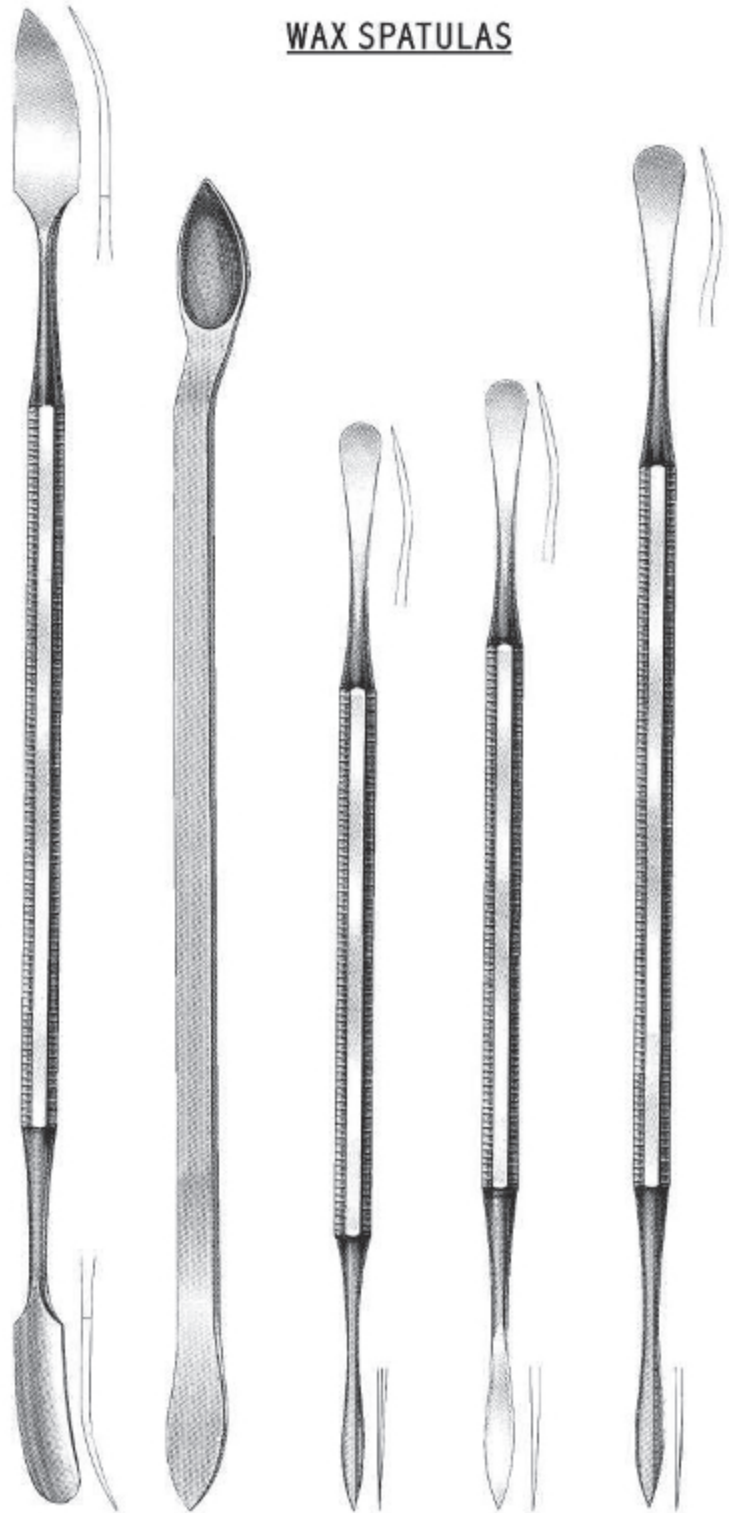

2140  
W-31

2141  
W-5

2142  
W-7

2143  
W-7A

2144  
W-7G

## Cement Spatulas



2145  
AGATHE



2146  
C-7



2147  
C-5



2148  
C-313



2149  
C-24A Rigid



2150  
C-24 Flexible



2151  
C-24 Flexible



2152  
24



2153  
A6



2154  
7 Wax



2155  
26



2156  
All Metal Spatulas with High Polish  
Stainless Steel Blade



2157  
31

**Spatulas**





## Spatulas



**Files, Hoes & Knives**

**FILES**

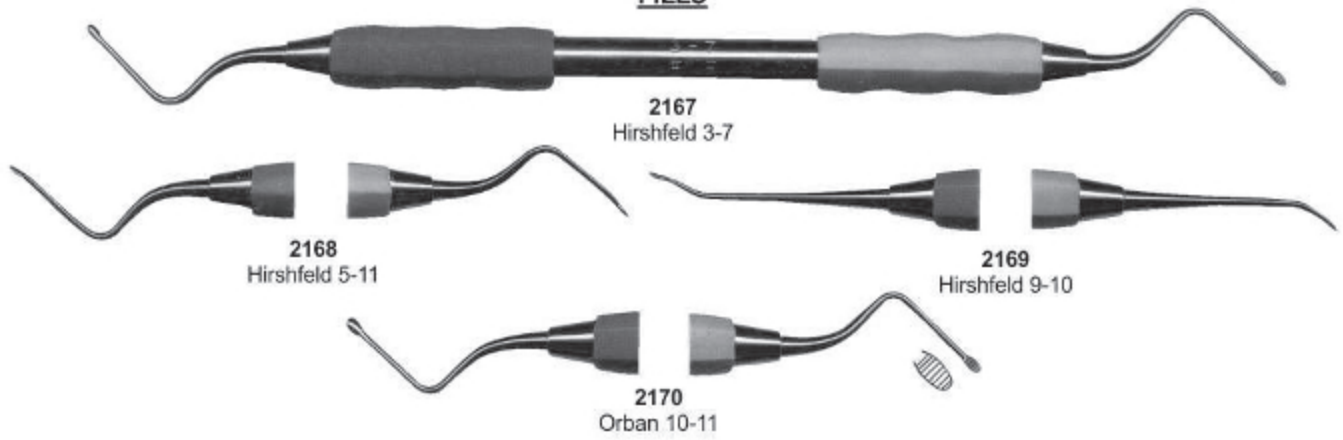

**HOES**

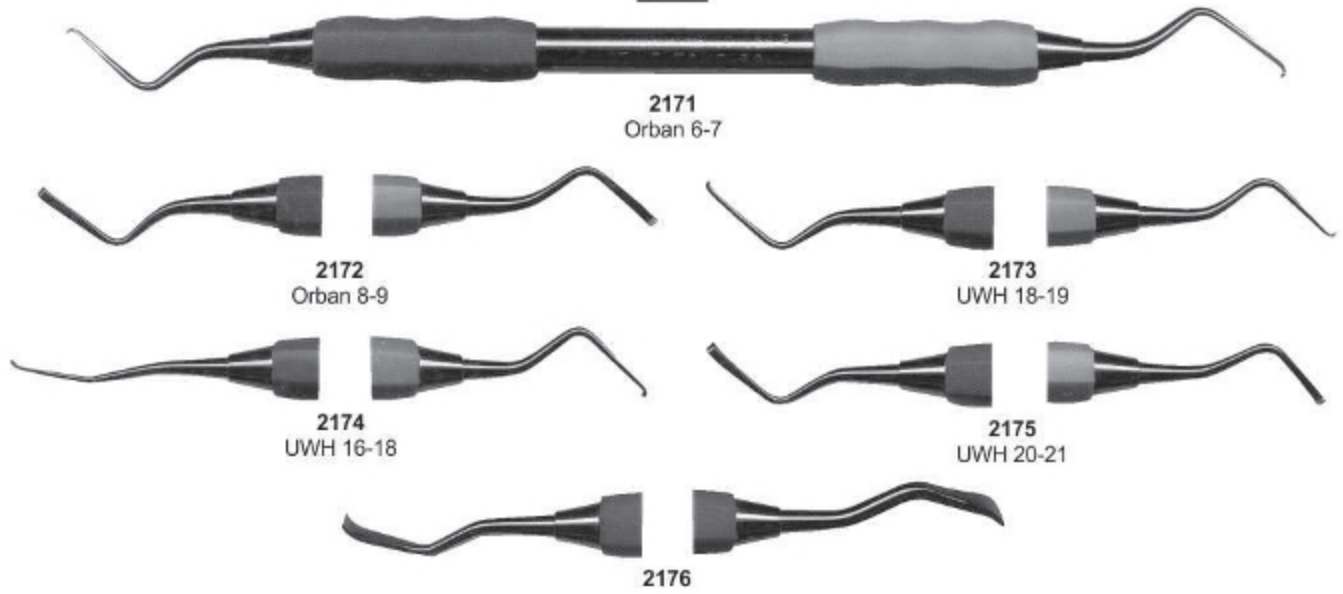

**KNIVES**

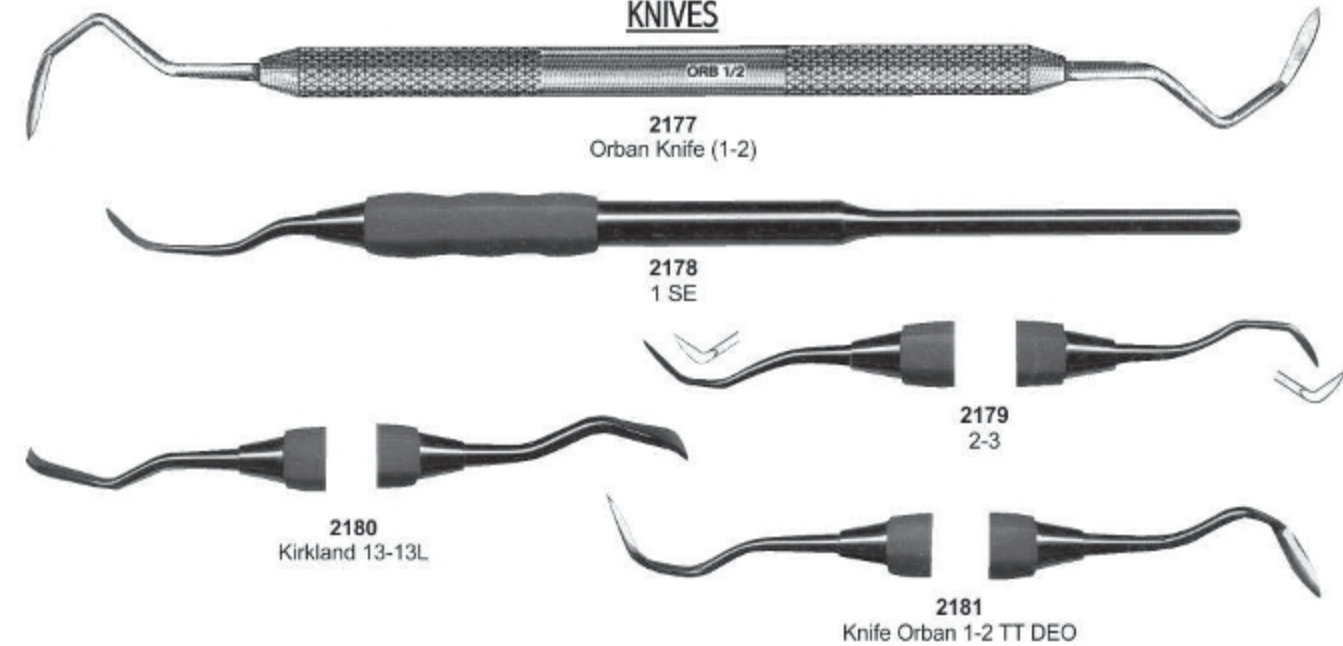

**Wax Knives**



**2182**  
 Fahnenstock  
 Fig. 1  
 12,5cm

**2183**  
 Fahnenstock  
 Fig. 2  
 17cm

**2184**  
 Lessmann  
 Fig. 1  
 12,5cm

**2185**  
 Lessmann  
 Fig. 2  
 17cm

**2186**  
 Con scodellino  
 Fig. 1  
 12,5cm

**2187**  
 Con scodellino  
 Fig. 2  
 17cm

**2188**  
 Ermert

**2189**  
 Ermert

**Wax Knives & Plaster Knives**



**2190**  
 18 cm  
 7 1/8"



**2191**  
 18 cm  
 7 1/8"



**2192**  
 17 cm  
 6 3/4"  
 Gritman



**2193**  
 17 cm  
 6 3/4"  
 Medicon



**2194**  
 Fig. 1  
 17 cm



**2195**  
 22 cm  
 8 3/4"



**2196**  
 22 cm  
 8 3/4"



**2197**  
 Gritman  
 Fig. 2  
 17 cm



**2198**  
 Fig. 3  
 16 cm



**2199**  
 Fig. 4  
 16 cm



**Crane-Kaplan, Chisels**

CRANE-KAPLAN



**2200**  
Ck1  
Pocket Marker



**2201**  
Ck2  
Pocket Marker



**2202**  
Knife



**2203**  
Dissector



**2204**  
Scaler

OCHSENBEIN



**2205**  
Ochsenbein  
Fig. 1



**2206**  
Ochsenbein  
Fig. 2



**2207**  
Ochsenbein  
Fig. 4

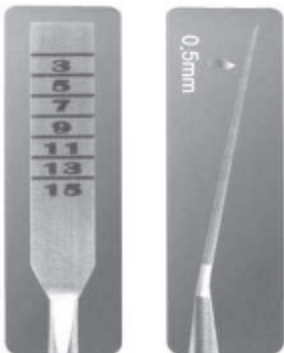

Split Chisel Set



**2208**  
Split Chisel  
6 mm Curved



**2209**  
Split Chisel  
6 mm Straight



**2210**  
Split Chisel  
4 mm Curved



**2211**  
Split Chisel  
4 mm Straight

**Bone Currettes**



**2212**  
No. 1



**2213**  
No. 2



**2214**  
No. 4



**2215**  
No. 5L



**2216**  
No. 6R



**2217**  
No. 75



**2218**  
No. 2/4



**2219-A**  
Miller  
11 cm



**2219-B**  
Lucas  
CL 84



**2219-C**  
Lucas  
CL 85



**2219-D**  
Lucas  
CL 86

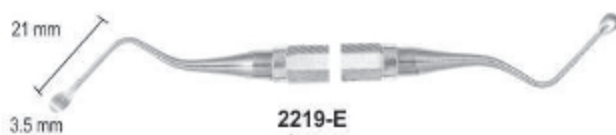

**2219-E**  
Lucas  
CL 87



**2219-F**  
Lucas  
CL 88

**100% actual size**

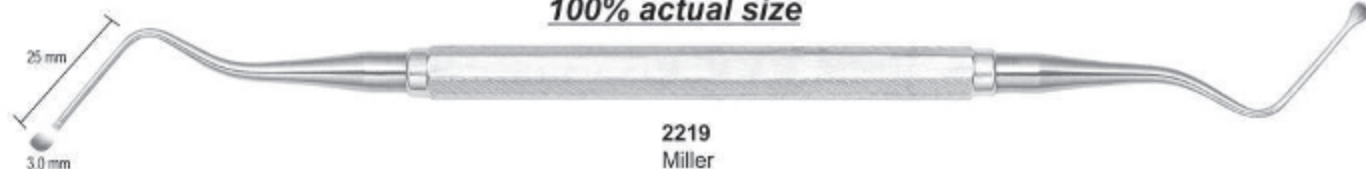

**2219**  
Miller  
10 cm

**Bone Files**

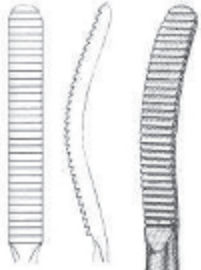

**2220**  
No. 10

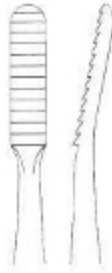

**2221**  
No. 33



**2222**  
MILLER  
No. 33

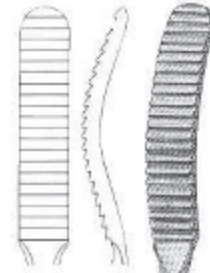

**2223**  
MILLER  
No. 64

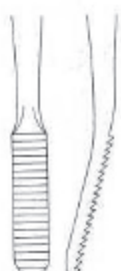
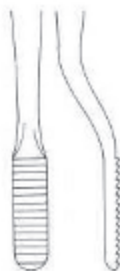



**Bone Files**

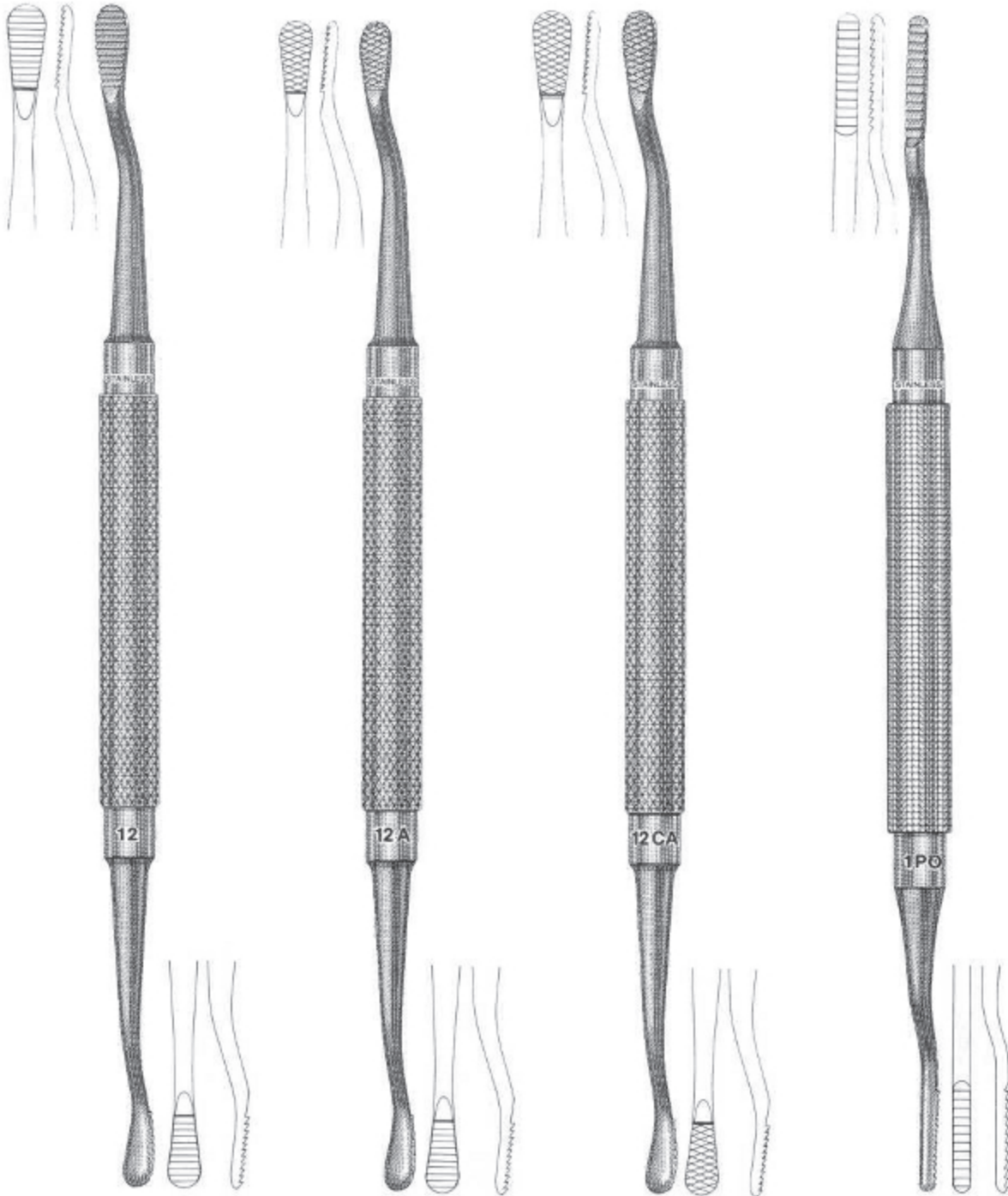

**2224**  
 HOWARD  
 No. 12

**2225**  
 HOWARD  
 No. 12A

**2226**  
 HOWARD  
 No. 12CA

**2227**  
 POLOKOFF  
 No. 1



**Bone Chisels**

GARDNER

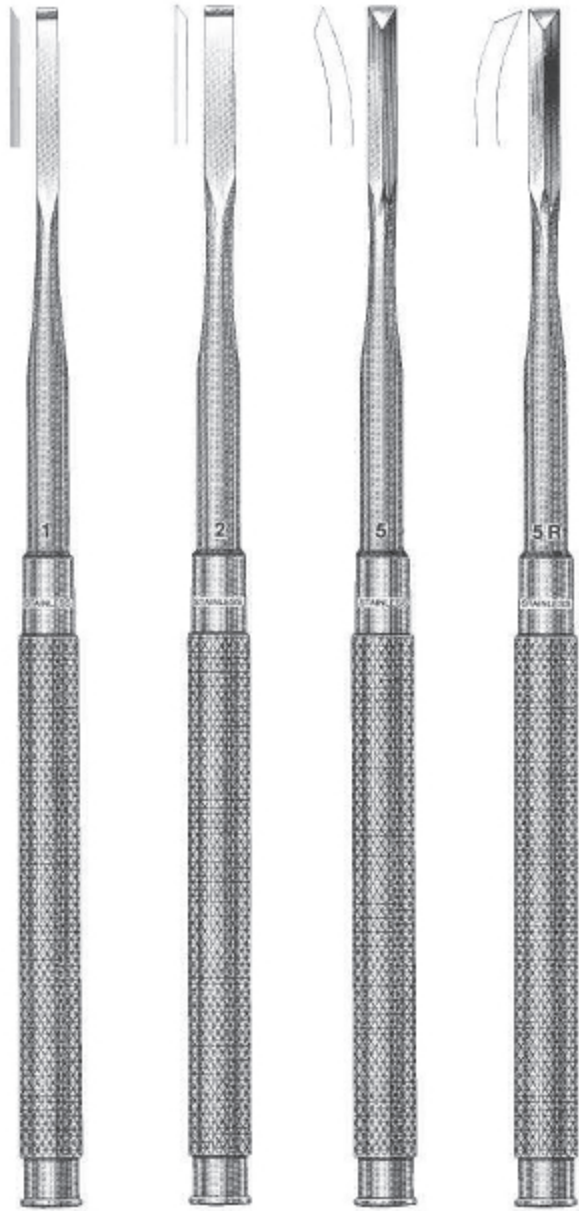

2228  
GARDNER  
No. 1

2229  
GARDNER  
No. 2

2230  
GARDNER  
No. 5

2231  
GARDNER  
No. 5R

WAKEFIELD



2232  
WAKEFIELD  
No. 1W

2233  
WAKEFIELD  
No. 2W

## Bone Chisels, Bone Mallets

### Bone Chisels and Gouges

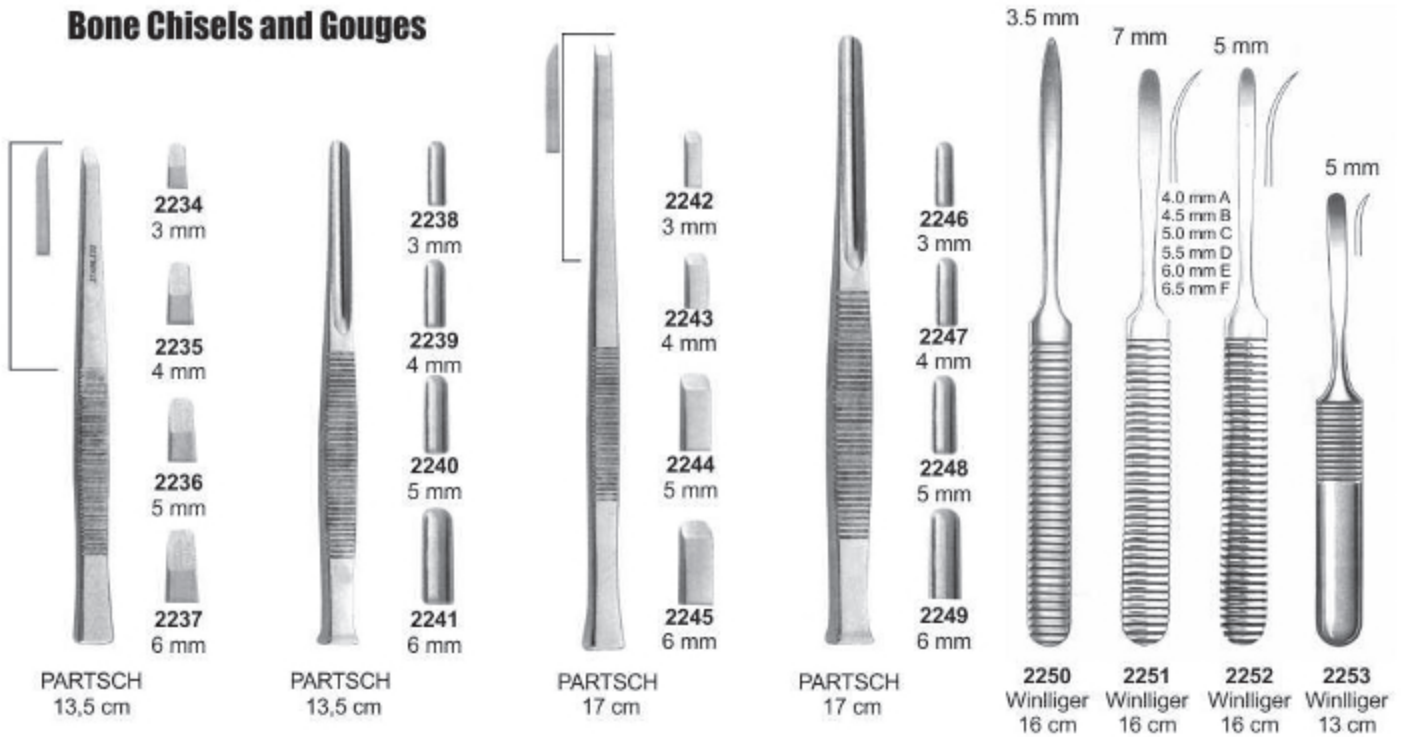

### Martelli chirurgici Mallet

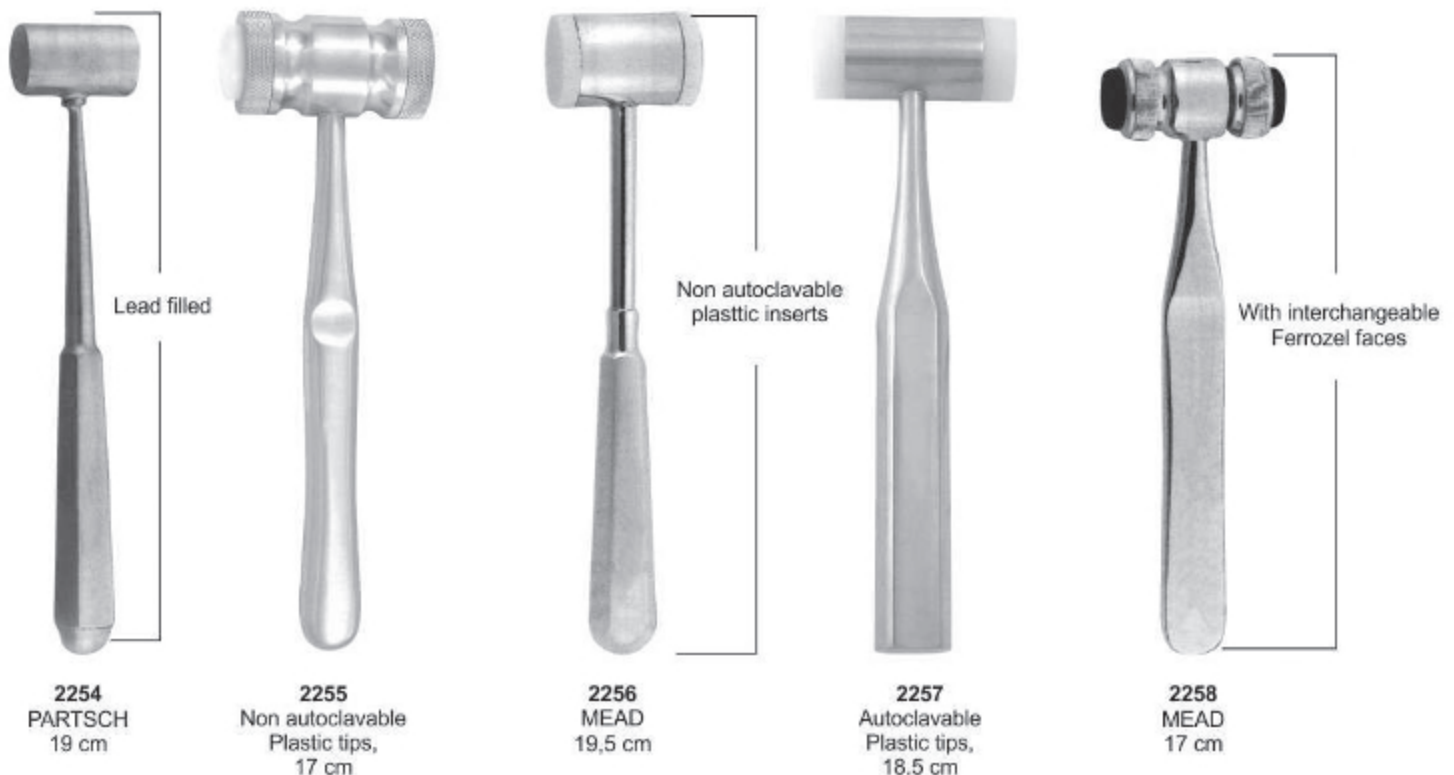

**Crown Remover**

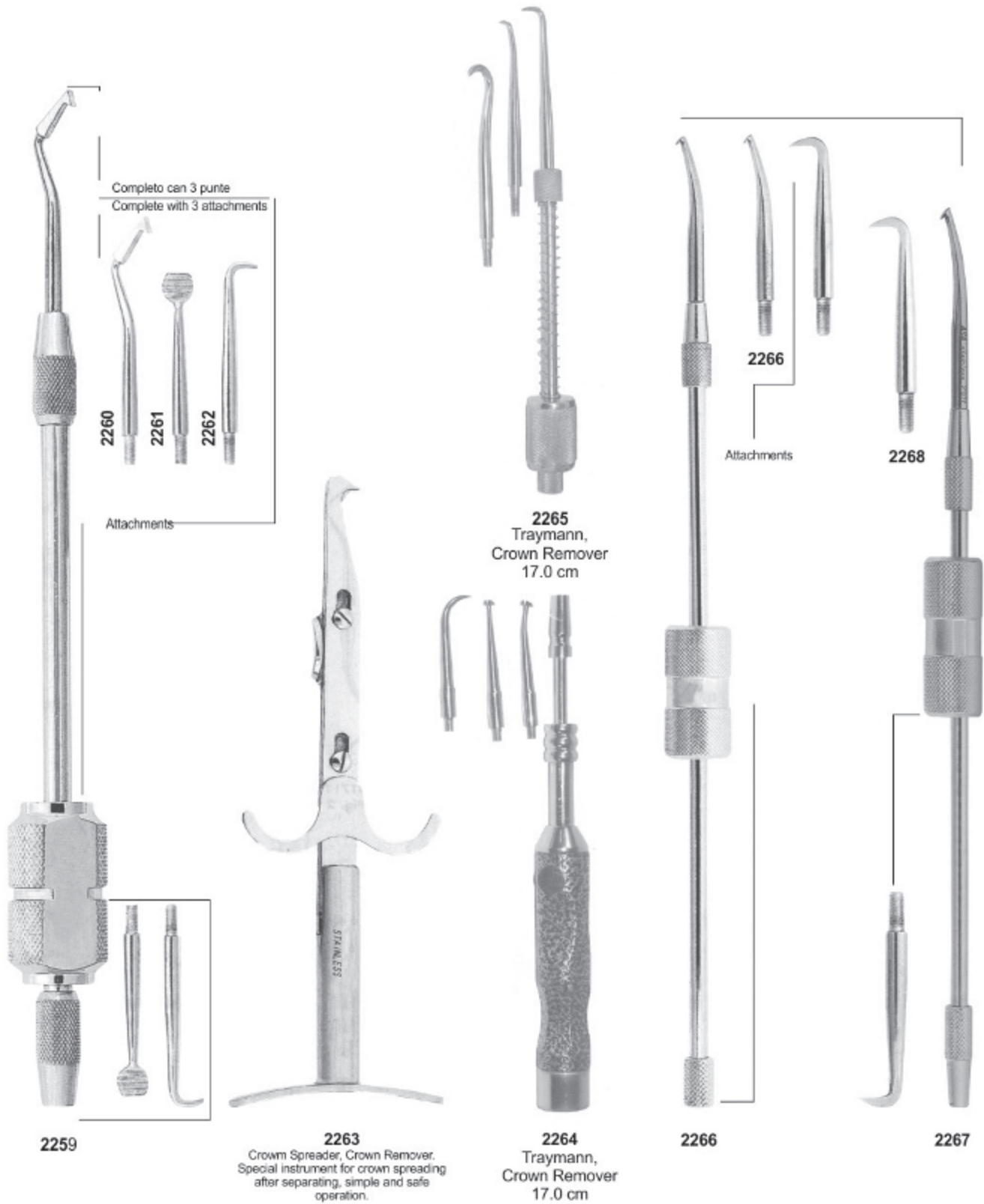

**Crown Instruments**



Fig.3  
2269  
Crown Remover

Fig.1  
Fig.2  
Fig.3  
2270  
Crown Remover

2271  
single loop  
with adapter

2272  
2273  
KEY/9 ADAPTER/8  
2274  
Crown & Bridge Holding Forceps  
With Support Ring

2275  
WYNMAN  
Crown Gripper, CARB-N-SERT

2276  
Crown opener

2277  
Mershon  
14.5 cm/5¾

2278  
Universal  
Hollow Handle

2279  
Fig.2

2280  
Fig.3

2281  
Fig.4



**Crown Instruments**



**2282**  
 Plaster Shear  
 210 mm



**2283**  
 Crown Removing Plier  
 14 cm



**2284**  
 MONTFORT  
 18 CM



**2285**  
 BOHM  
 16 cm



**2286**  
 Telescope Crown  
 Plier, Diamond coated  
 13.0 cm



**2287**  
 Telescope Crown  
 Plier, Diamond coated  
 13.0 cm



**2288**  
 Telescope Crown Plier  
 13.0 cm gerieften Maul  
 15.0 cm gerieften Maul  
 13.0 cm gelatts Maul  
 15.0 cm gelatts Maul



**2289**  
 Telescope Crown  
 Plier, Fine  
 15.0 cm

## Implant Instruments



**2290**  
 1P  
 150 mm



**2291**  
 Fig. 1  
 155 mm

Ø 2 mm



**1P**  
 150 mm

Ø 2.7 mm

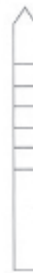

**2P**  
 150 mm

Ø 3.25 mm



**3P**  
 150 mm

Ø 3.8 mm

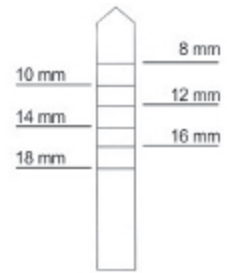

**4P**  
 150 mm

Ø 3 mm



**1T**  
 150 mm

Ø 4 mm



**2T**  
 150 mm

Ø 5 mm



**3T**  
 150 mm

Ø 1.60 mm



**1**  
 155 mm

Ø 1.90 mm



**2**  
 155 mm

Ø 2.80 mm



**3**  
 155 mm



**4**  
 155 mm



**5**  
 155 mm



**6**  
 155 mm

## Implant Instruments



**2292**  
Fig. 1B  
165 mm

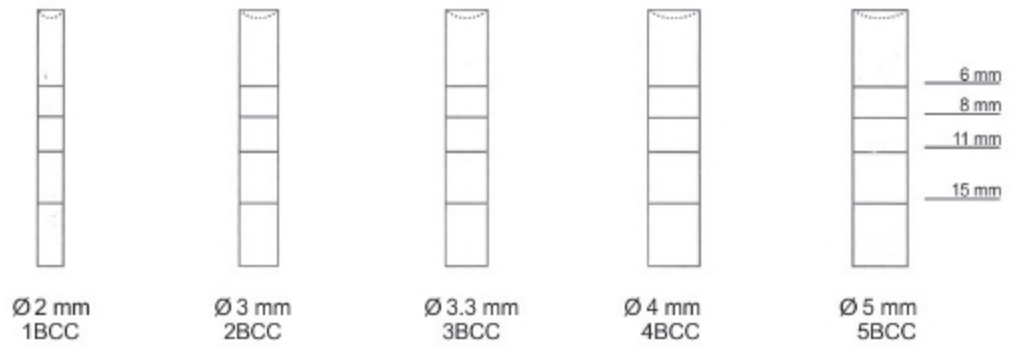
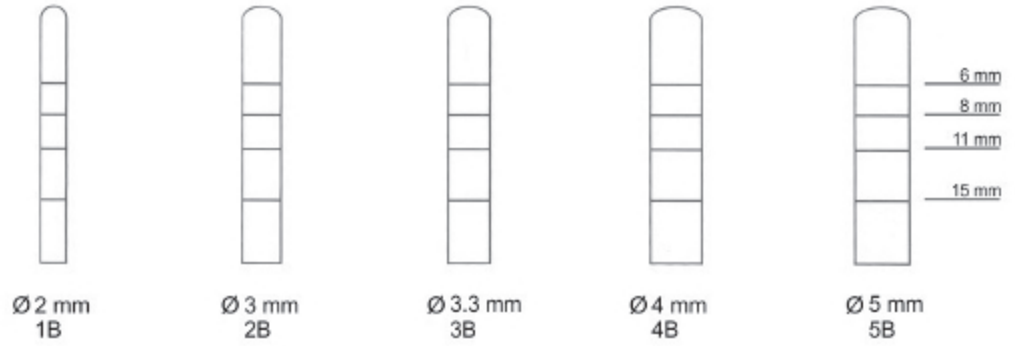

**2293**  
Fig. 1  
155 mm

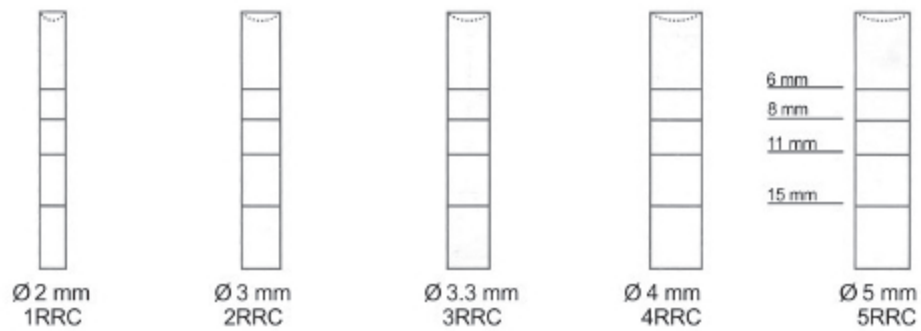
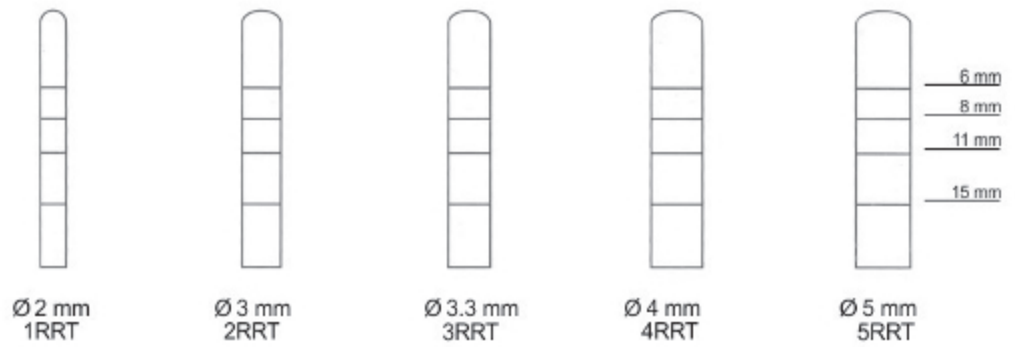

## Implant Instruments

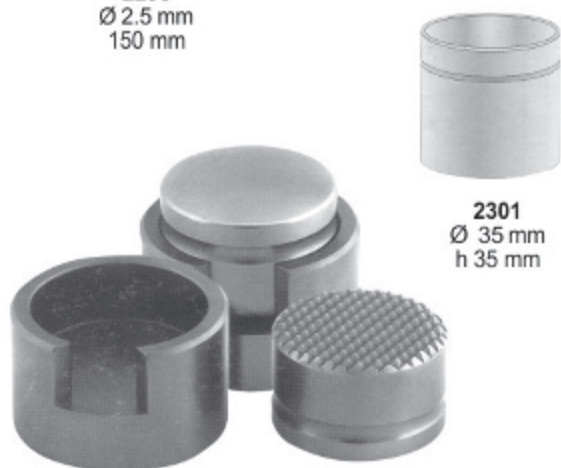
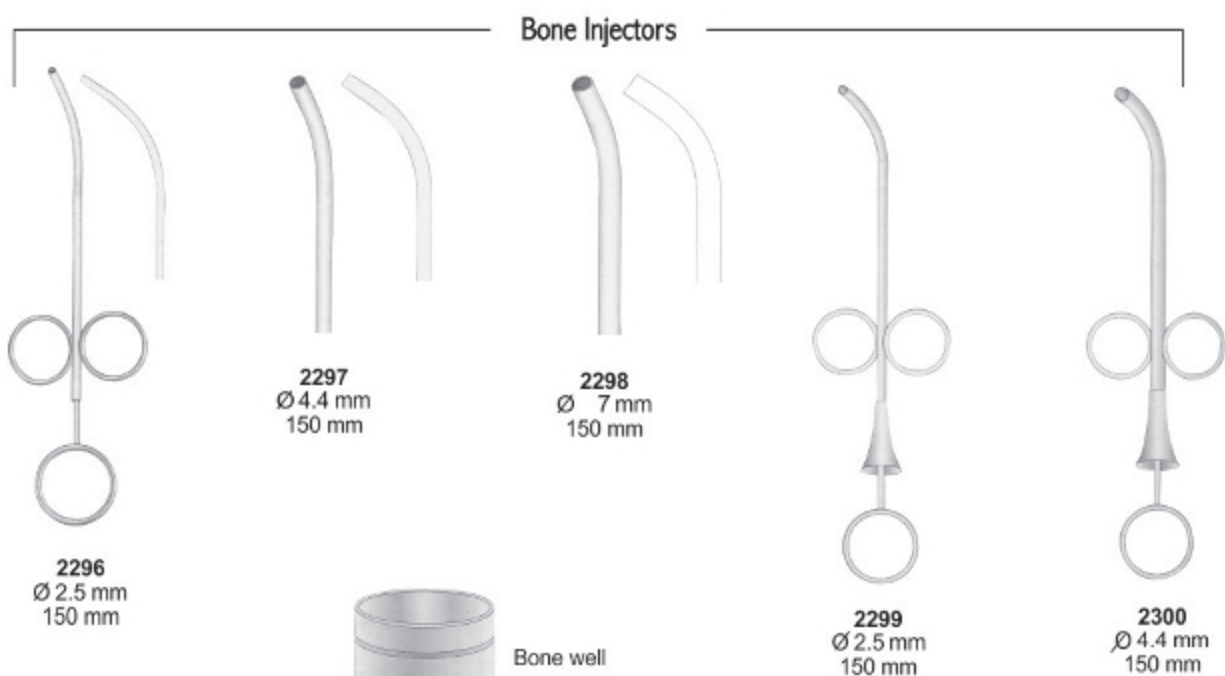
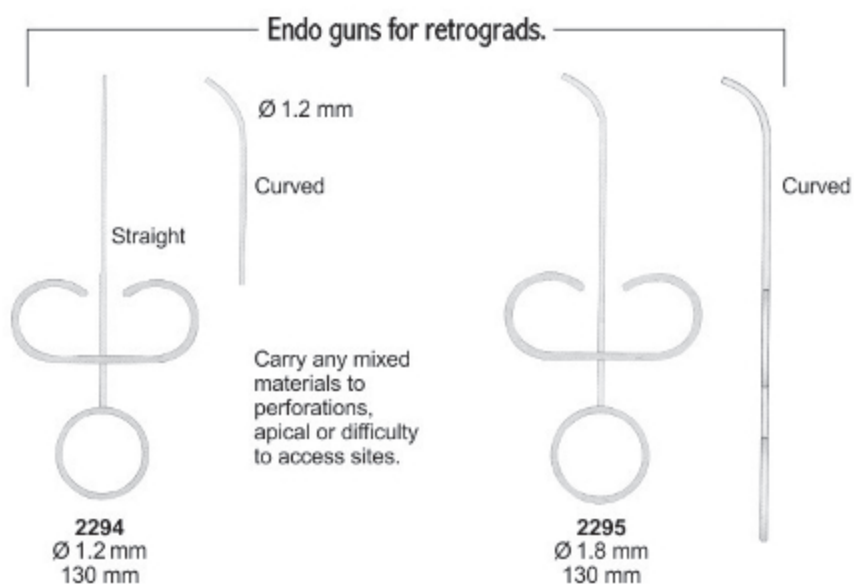

2302  
Grinders for autogenous

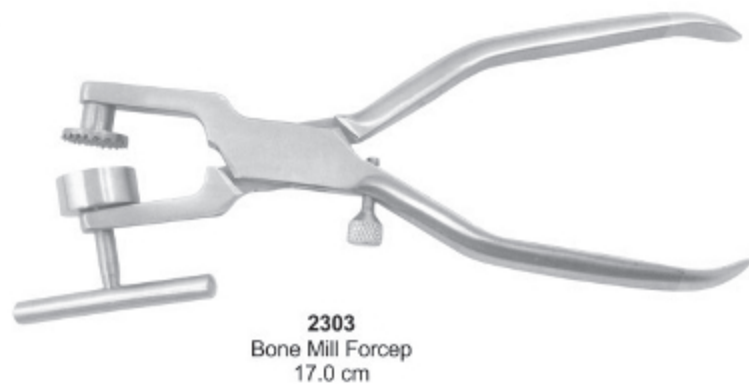



## Suction Tubes, bone Pluggers & Rongeurs

### Suction Tubes



### Bone Pluggers

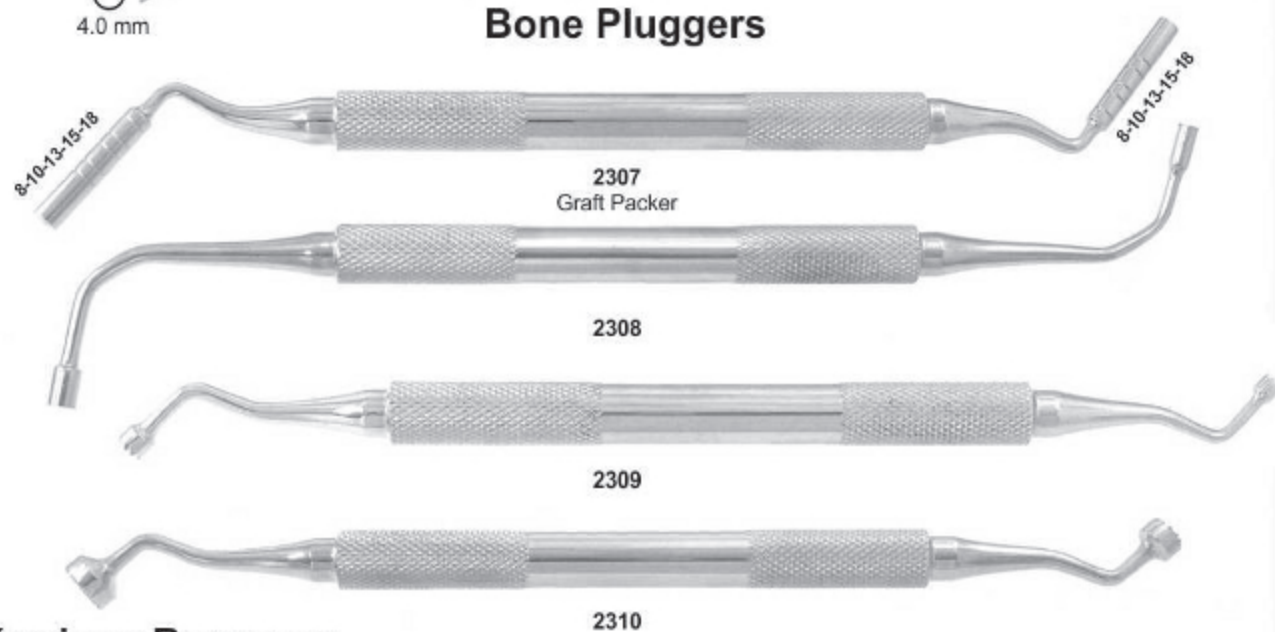

### Kerrison Rongeurs



( 1.5 mm inside ) 2311  
( 2.0 mm inside ) 2312  
( 3.0 mm inside ) 2313  
( 4.0 mm inside ) 2314  
( 4.5 mm inside ) 2315  
**16.5 cm**



( 1.0 mm inside ) 2316  
( 2.0 mm inside ) 2317  
( 2.50 mm inside ) 2318  
**16.5 cm**

# SECTION 05

**SEASONED**  
*Take away the Beauty*  
Since 1985

- ▶ Measuring Instruments
- ▶ Amalgam Guns & Carriers
- ▶ Retainers
- ▶ Rubber Dam Instruments
- ▶ Dental Syringes
- ▶ Tweezers
- ▶ Sterilizing & Lab. Instruments



## Implant Instruments



**2319**  
Fig. 1  
170 mm

**2320**  
Fig. 2  
175 mm

**2321**  
Fig. 3  
170 mm

**2322**  
LUCAS  
Fig. 88  
170 mm



**2323** Fig. 1  
Ø 3-4 mm

**2324** Fig. 2  
Ø 6-8 mm

Bone Compactors.

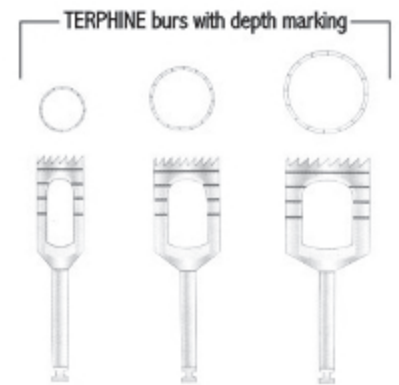

**2325**  
Ext. Ø 3.5 mm  
Int. Ø 3 mm

**2326**  
Ext. Ø 6 mm  
Int. Ø 5 mm

**2327**  
Ext. Ø 8.5 mm  
Int. Ø 7.55 mm

**2328**  
Ext. Ø 11 mm  
Int. Ø 10 mm

## Sinus lift instruments



**2329**  
Fig.1

**2330**  
Fig.2

**2331**  
Fig.3

**2332**  
Fig.4

**2333**  
Fig.5

**2334**  
Fig.6

**2335**  
Fig.7

**2336**  
Fig.8

**2337**  
Fig.9

## Suction Tubes

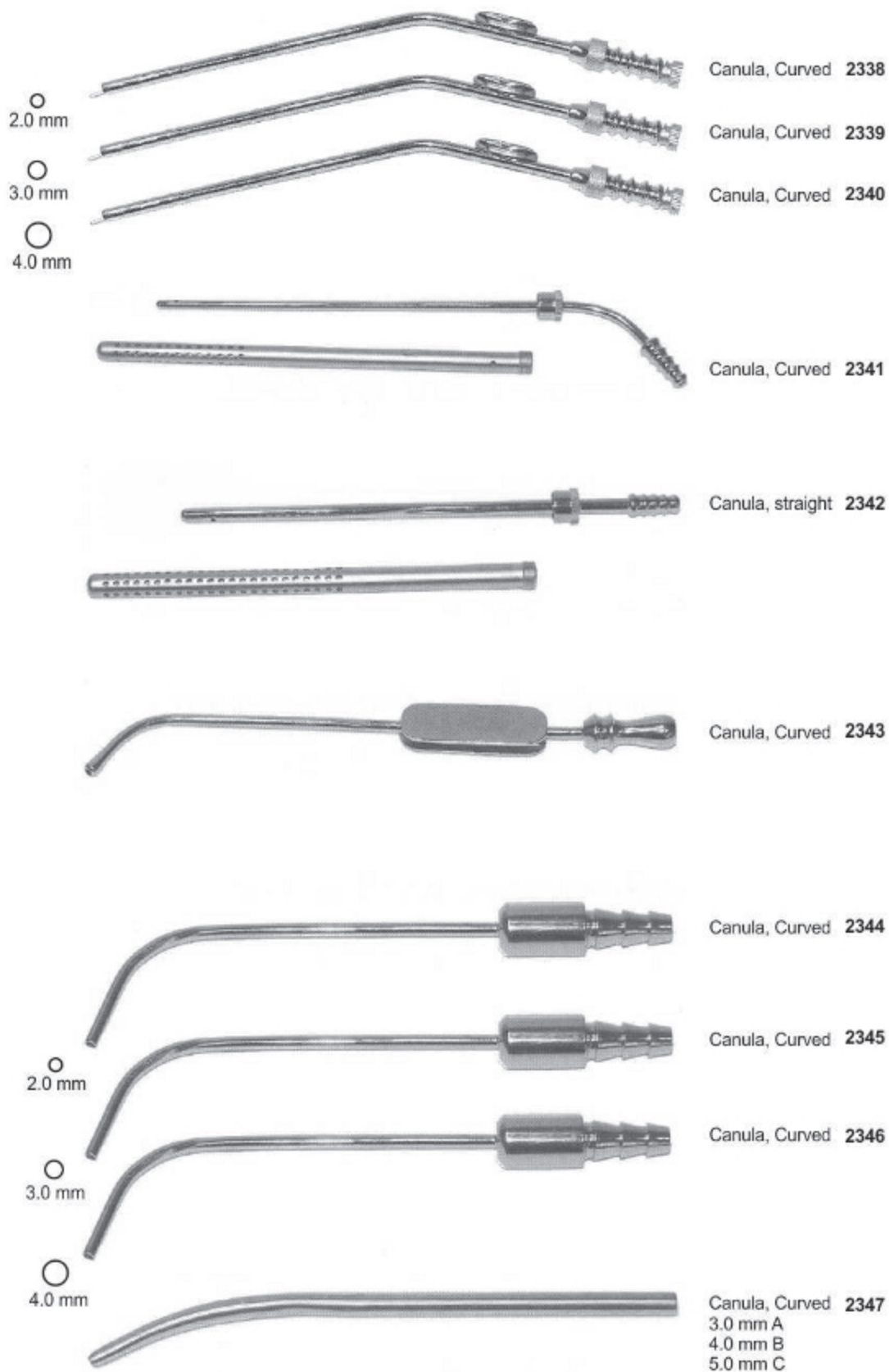



## Measuring Instruments



**2348**  
BOLEY Gauge



**2349**  
ZURICHER  
130 mm



**2350**  
VERNIER  
12 cm



**2351**  
VERNIER



**2352**  
VERNIER Gauge



**2353**  
VERNIER Gauge



**2355**  
Finger Ruler



**2354**  
LWANSON  
Crown Gauge



**2356**  
LWANSON  
Crown Gauge



**2357**  
Sliding Gauge  
10 cm



**2358**  
Spring Bow Divider  
6" Radius



**2359**  
VERNIER  
Gauge



**2360**  
ALBEE



**2361**  
Height Gauge  
Wick Type

## Bone Gauge & Measuring Instruments



**2362**  
Bone Gauge



**2363**  
Bone Caliper  
15 cm



**2364**  
Castroviejo



**2365 B**  
Straight



**2365 A**  
Castroviejo  
Curved



**2366 C**  
Castroviejo  
Straight

**2366 D**  
Curved



**2367**  
Gauge



**2368**  
Castroviejo  
Straight

**2369**  
Curved



**2370**  
Castroviejo  
Straight

**2370 A**



**2371**  
Curved



**2373**  
Boone - Gauge



**2372**  
Castroviejo

**2374** **2375**  
Curved Straight



**2376**  
Bracket Gauge. Ant/Post



**Amalgam Guns & Carriers**

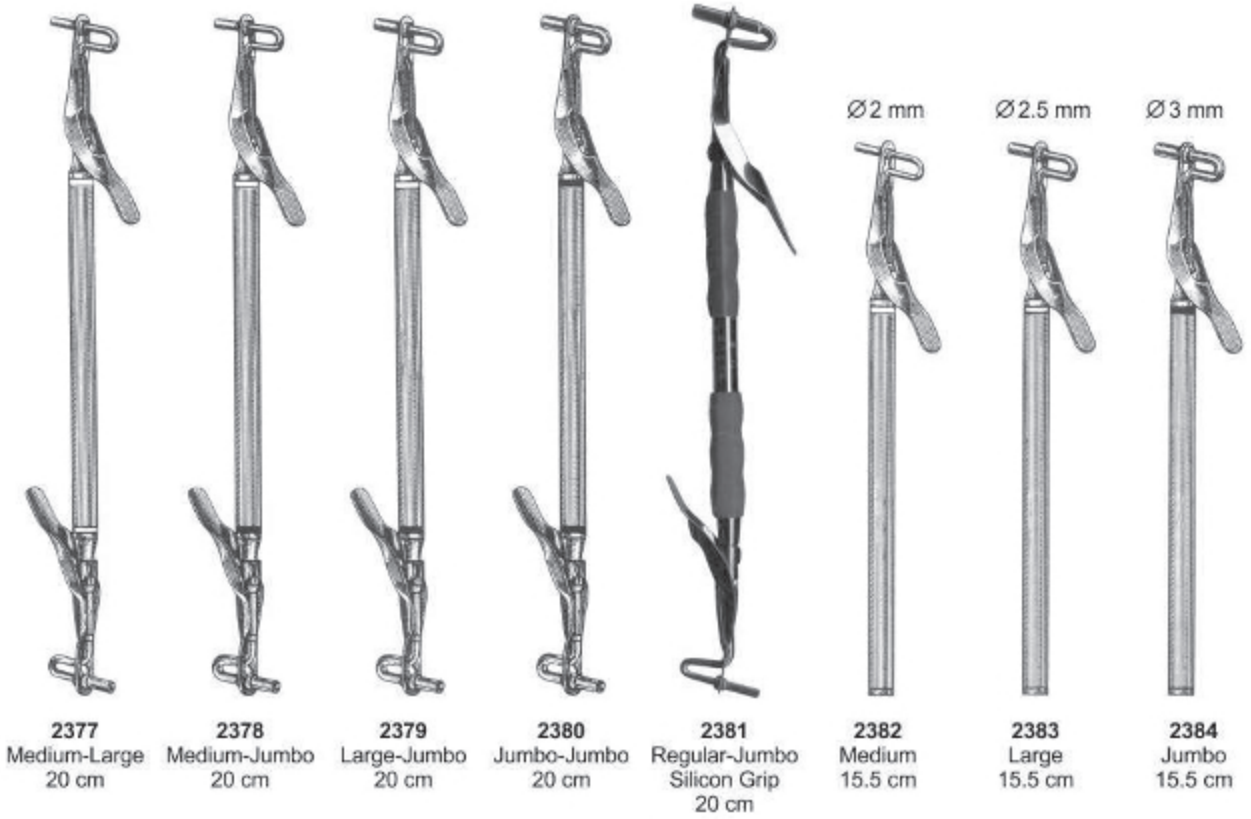

**2377** Medium-Large 20 cm  
**2378** Medium-Jumbo 20 cm  
**2379** Large-Jumbo 20 cm  
**2380** Jumbo-Jumbo 20 cm  
**2381** Regular-Jumbo Silicon Grip 20 cm  
**2382** Medium 15.5 cm  
**2383** Large 15.5 cm  
**2384** Jumbo 15.5 cm



**2385** 145 mm  
**2386** 130 mm  
 Ø2 mm  
**2387** Straight 15 cm  
 Ø2 mm  
**2388** 15 cm  
 Ø2 mm  
**2389** 15 cm 90°  
**2390** Amalgam Well Non Skid Base Ø3.5 mm



**Retainers, Bands, Strip Holder Clips, Napkin Holders**

Retainers

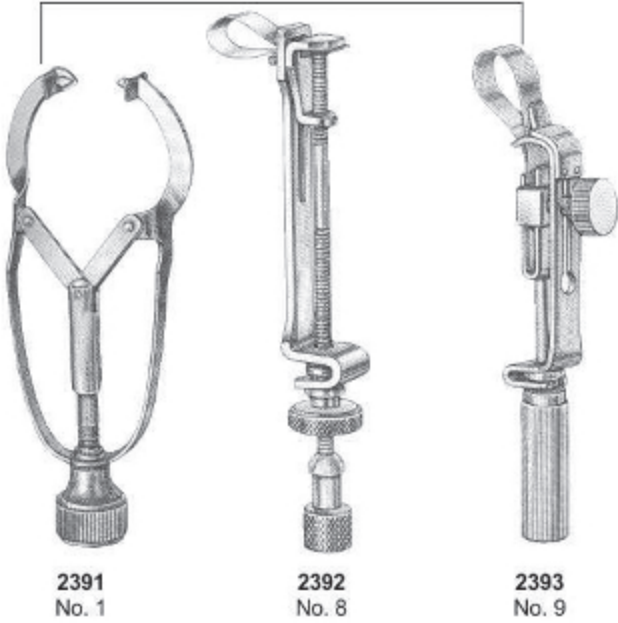

"Toffemire" Type Retainers



Toffemire Bands

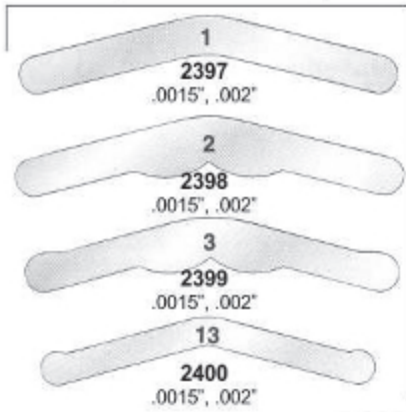

2401  
X-Ray Holder  
Small



Set of 10  
2402  
Film Hanger

Napkin Holders



Strip Holders

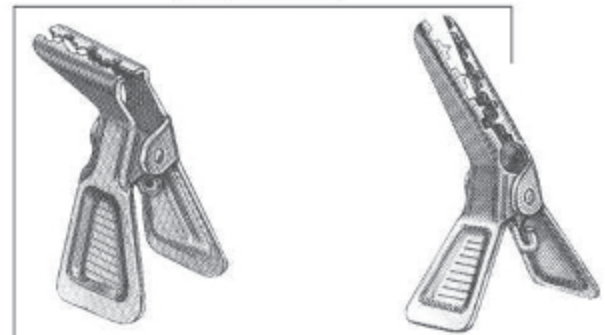

2405  
Finger Protector  
Small

2406  
Medium

2407  
Large



## Rubber Dam Instruments



**2410**  
 IVORY  
 Light weight, 170 mm



**2411**  
 BREWER  
 175 mm



**2412**  
 BREWER  
 175 mm



**2413**  
 WHITE  
 175 mm



**2414**  
 IVORY  
 170 mm



**2415**  
 AINSWORTH  
 Rubber Dam Punch  
 170 mm



**2416**  
 AINSWORTH  
 Ainsworth  
 Rubber Dam Punch  
 170 mm



**2417**  
 AINSWORTH  
 Rubber Dam Punch  
 170 mm

### Articulating Paper Forceps



**2421**  
 MILLER  
 Articulating  
 Forceps  
 15 cm



**2422**  
 MILLER  
 Articulating  
 Forceps  
 15 cm



**2418**  
 "IV" Type  
 Rubber Dam Punch  
 160 mm



**2419**  
 Plastic Rubber Dam  
 Frame 242

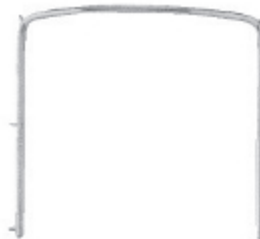

**2420**  
 Rubber Dam Holder  
 Stainless Steel Pins

## Rubber Dam Clamps

### LOWER MOLARS



2423  
76D-W3



2424  
76D-3



2429  
76D-7A



2430  
76D-7



2435  
76D-12A



2436  
76D-13A



2441  
76D-26



2442  
76D-28



2445  
76D-W8A



2446  
76D-8A



2447  
76D-10



2448  
76D-11



2451  
76D-24

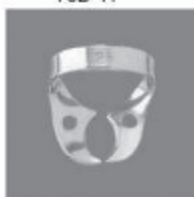

2452  
76D-25

### UPPER MOLARS



2425  
76D-4



2426  
76D-5



2431  
76D-8



2432  
76D-26N



2437  
76D-30



2438  
76D-31



2443  
76D-201



2444  
205

### MOLARS

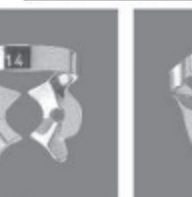

2449  
76D-14



2450  
76D-118



2453  
76D-27



2454  
76D-56

### PREMOLARS



2427  
76D-0



2428  
76D-1



2433  
76D-2A



2434  
76D-2



2439  
76D-27N



2440  
76D-29

### ANTERIOR



2456  
76D-00



2457  
76D-1A



2458  
76D-9



2459  
76D-212

2455  
76D-14A

## Aspirating Syringes

4969/CO



4969/F



4969/CV



**2460**  
ml 1,8  
EU

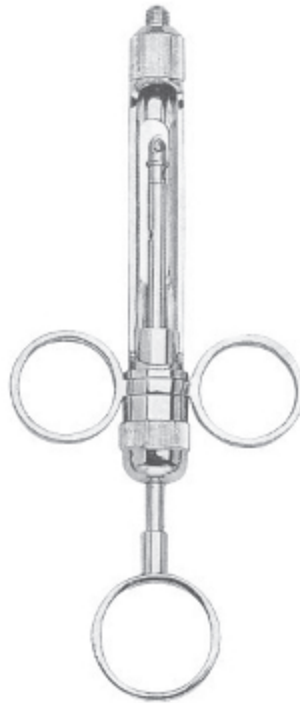

**2461**  
ml 1,8  
EU/AM



**2462**  
ml 1,8  
EU/AM



**2463**  
Fig. 1  
ml 1,8  
EU



**2464**  
Fig. 1  
ml 1,8  
EU



**2465**  
Autoclavable  
black plastic handle  
passive automatic  
aspiration.



**2466**  
Fig. 1  
ml 1,8  
EU/Am



**2467**  
Fig. 1  
ml 1,8  
EU/Am



**2468**  
Fig. 1  
ml 1,8  
EU/Am



**2469**  
ml 1,2  
EU/Am

**Syringes**

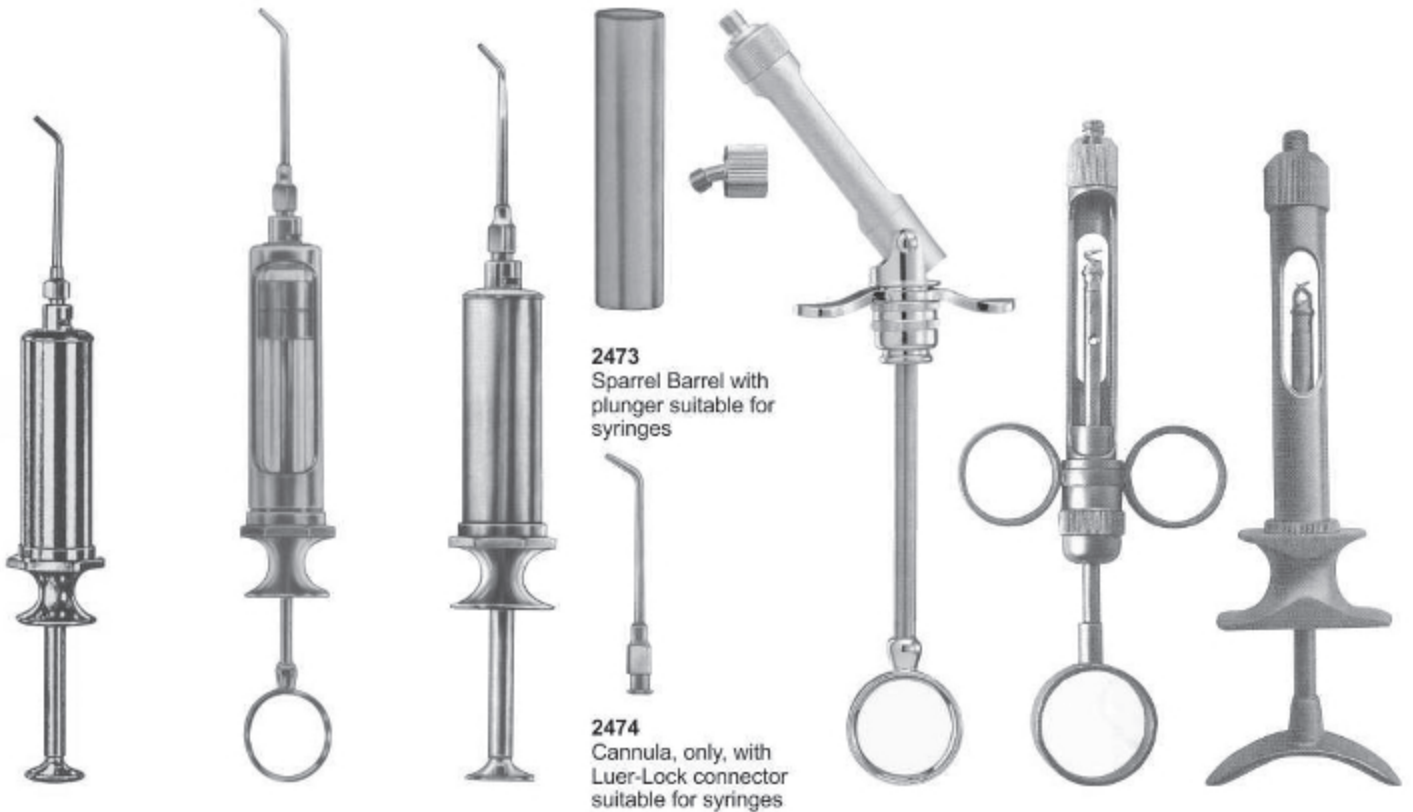

**2470**  
 Water Syringe  
 complete with  
 1 cannula (Lure-Lock)

**2471**  
 Water Syringe  
 complete with  
 1 cannula (Lure-Lock)

**2472**  
 Metal Water Syringe  
 self-filling, with 1  
 cannula (Lure-Lock)

**2473**  
 Sparrel Barrel with  
 plunger suitable for  
 syringes

**2474**  
 Cannula, only, with  
 Luer-Lock connector  
 suitable for syringes

**2475**  
 Articulating  
 Barrel Syringe

**2476**  
 ml 1,8

**2477**  
 ml 1,8

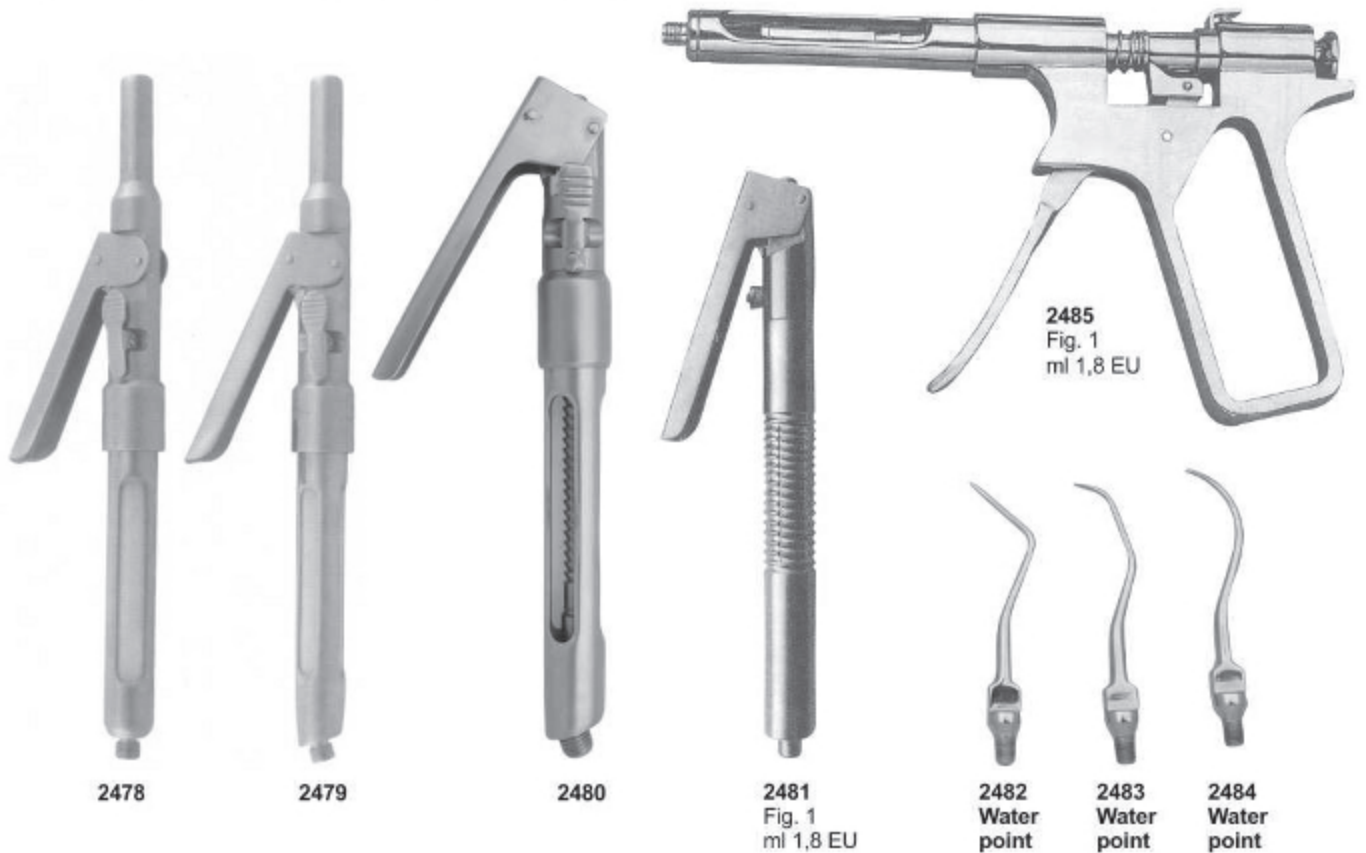

**2478**

**2479**

**2480**

**2481**  
 Fig. 1  
 ml 1,8 EU

**2485**  
 Fig. 1  
 ml 1,8 EU

**2482**  
 Water  
 point

**2483**  
 Water  
 point

**2484**  
 Water  
 point



**Dental Tweezers**



**2486**  
 ADSON  
 Curved 14 cm

**2487**  
 ADSON  
 1X2 / 12 cm

**2488**  
 ADSON  
 12 cm

**2489**  
 MICRO ADSON  
 15 cm

**2490**  
 STANDARD  
 14, 18, 25 cm

**2491**  
 CUSHING  
 18 cm

**2492**  
 Curved

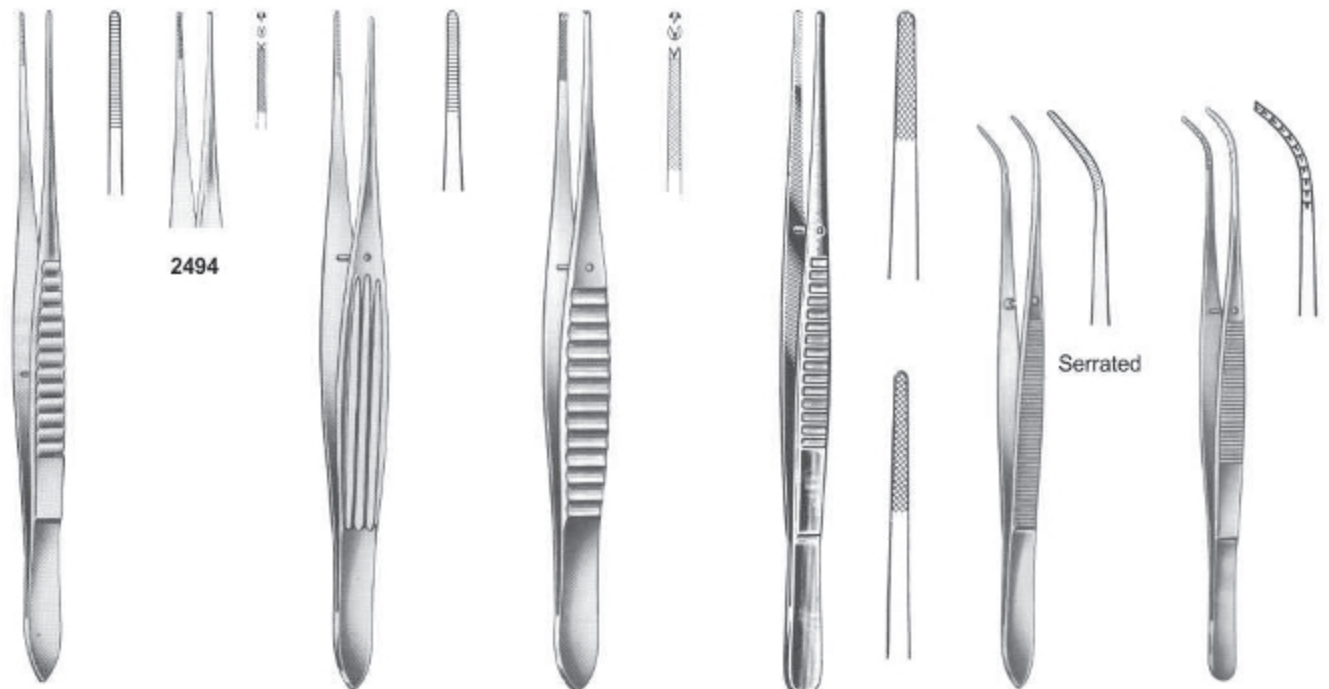

**2493**  
 SELECT  
 15, 18, 20 cm

**2494**

**2495**  
 MCINDOE  
 15 cm

**2496**  
 GILLIES  
 15 cm

**2497**  
 WAUGH  
 15, 20 cm

Serrated

**2498**  
 PERRY  
 13 cm

**2499**  
 KOPP  
 15.5 cm

**Dental Tweezers**



**2500**  
 COLLEGE  
 15 cm



smooth



**2501**  
 COLLEGE  
 15 cm



serrated



**2502**  
 COLLEGE  
 15 cm



smooth



**2503**  
 COLLEGE  
 15 cm



serrated



**2504**  
 COLLEGE  
 15 cm



smooth



**2505**  
 COLLEGE  
 15 cm



serrated



**2506**  
 COLLEGE  
 15 cm



smooth



**2507**  
 COLLEGE  
 15 cm



serrated

# SECTION 06

**SEASONED**  
*Take away the Beauty*  
Since 1985

- ▶ Endodontic Forceps
- ▶ Tissue Forceps
- ▶ Retractors
- ▶ Mouth Gags



**Dental Tweezers**



**2508**  
 MERIAM  
 16 cm



smooth



**2509**  
 MERIAM  
 16 cm



serrated



**2510**  
 MERIAM  
 16 cm



smooth



**2511**  
 MERIAM  
 16 cm 1



serrated



**2512**  
 MERIAM  
 16 cm



smooth



**2513**  
 MERIAM  
 16 cm



serrated



**2514**  
 MERIAM  
 16 cm



smooth



**2515**  
 MERIAM  
 16 cm



serrated



**Dental Tweezers**

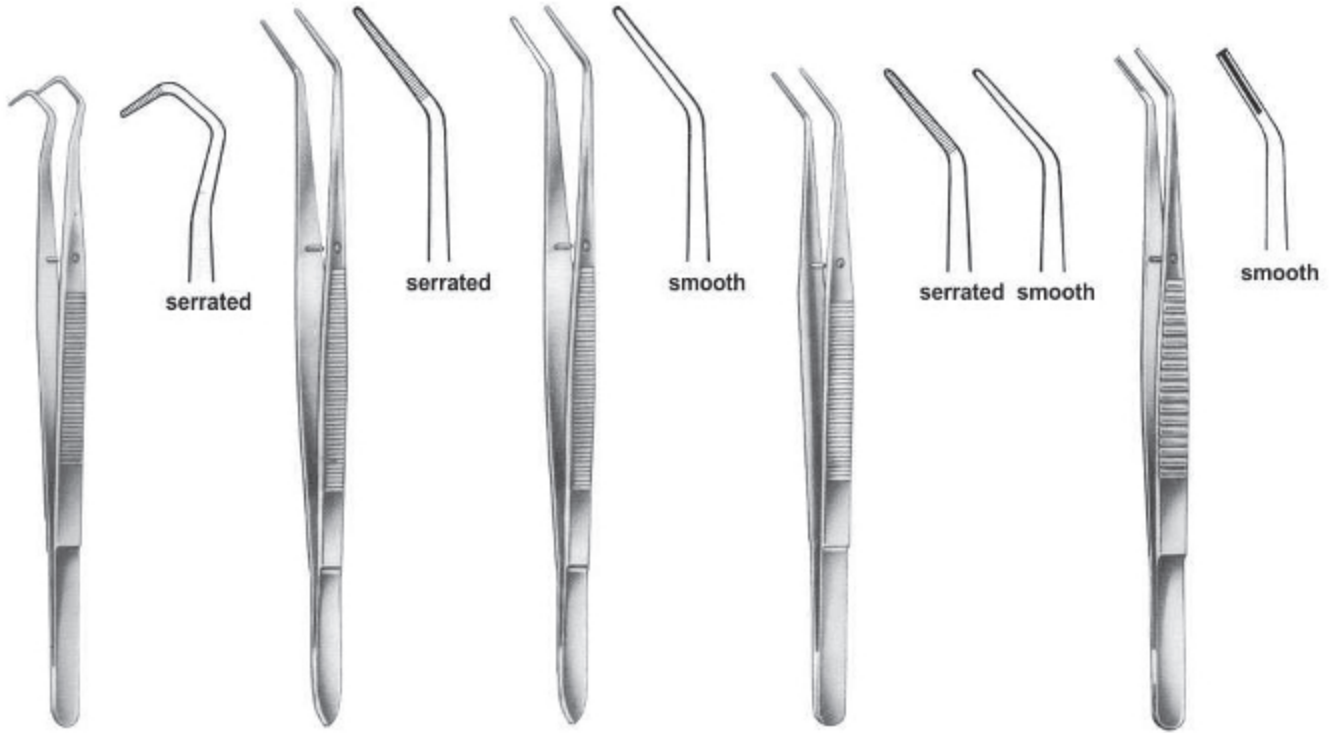

**2516**  
 COLLEGE  
 14.5 cm, 5<sup>3</sup>/<sub>4</sub>"

**2517**  
 FLAGG  
 16 cm, 6<sup>1</sup>/<sub>4</sub>"

**2518**  
 FLAGG  
 16 cm, 6<sup>1</sup>/<sub>4</sub>"

**2519**  
 LANDGRAF  
 15 cm, 6"

**2520**  
 15,5 cm, 6<sup>1</sup>/<sub>8</sub>"

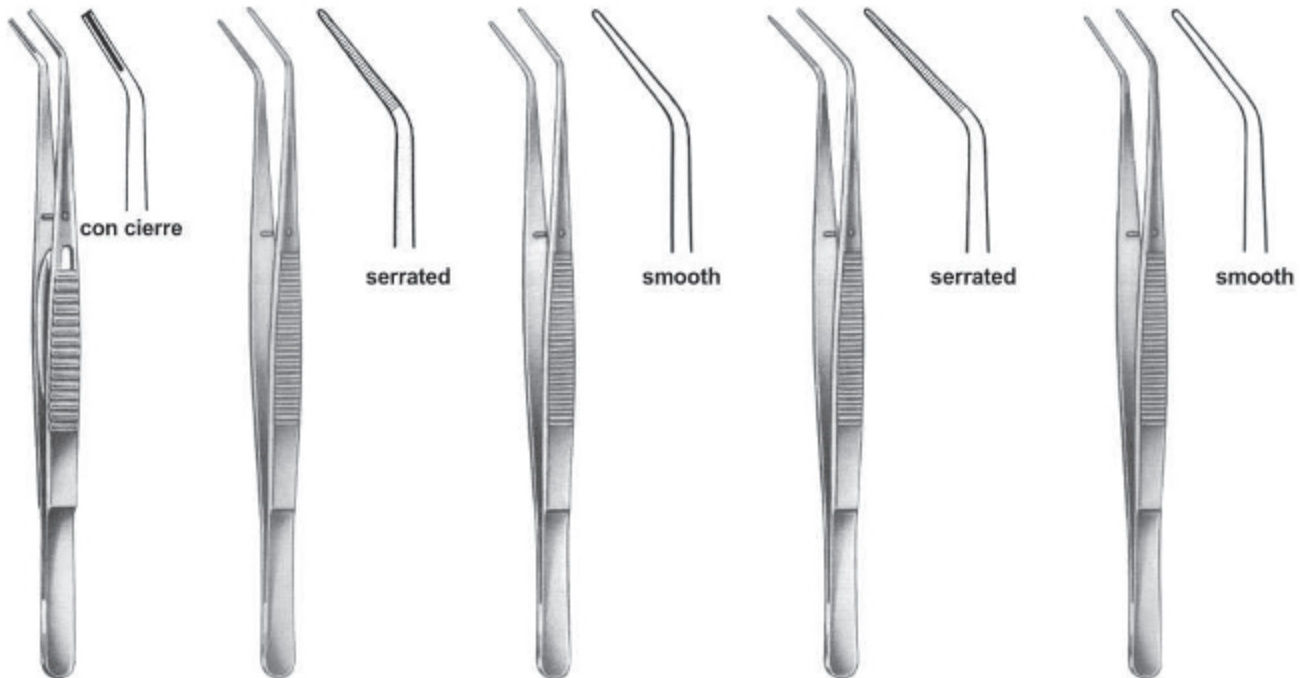

**2521**  
 15.5 cm, 6<sup>1</sup>/<sub>8</sub>"

**2522**  
 LONDON-COLLEGE  
 15 cm, 6"

**2523**  
 LONDON-COLLEGE  
 15 cm, 6"

**2524**  
 LONDON-COLLEGE  
 15 cm, 6"

**2525**  
 LONDON-COLLEGE  
 15 cm, 6"

**Dental Tweezers**



**2526**  
 LONDON-COLLEGE  
 15 cm, 6"



**2527**  
 LONDON-COLLEGE  
 15 cm, 6"



con cierre



**2528**  
 MERIAM  
 16 cm, 6 1/4"



serrated



smooth



**2529**  
 ALLEN  
 18 cm, 7 1/8"



**2530**  
 ALBRECHT  
 16 cm, 6 1/4"



**2531**  
 ALBRECHT  
 16 cm, 6 1/4"



**2532**  
 16 cm, 6 1/4"



**2533**  
 16 cm, 6 1/4"



**2534**  
 16 cm, 6 1/4"



**Sterilizing & Lab Instruments**



**2535**  
 DAVIS  
 6"



**2536**  
 Grasping Forceps  
 6 1/4"



**2537**  
 Mesh Bur & Diamond Holder  
 Large, 2 1/8" Diameter



**2538**  
 Soldering Tweezers  
 6 1/4"



**2539**  
 Narrow Fine  
 4 3/4"



**2540**  
 Super Fine  
 4 3/8"



**2541**  
 Fine Curved  
 4 1/2"



**2542**  
 Bonding Bracket  
 Holder  
 136 mm



**2543**  
 Bonding Bracket  
 Holder  
 135 mm



**2544**  
 Bonding Bracket  
 Holder  
 135 mm



**2545**  
 Bonding Bracket  
 Holder  
 140 mm

## Endodontic Forceps



**2546**  
Endo Forceps  
4 3/4"



**2547**  
PEETS Forceps  
4 3/4", Useful For  
Removing Broken  
Instruments

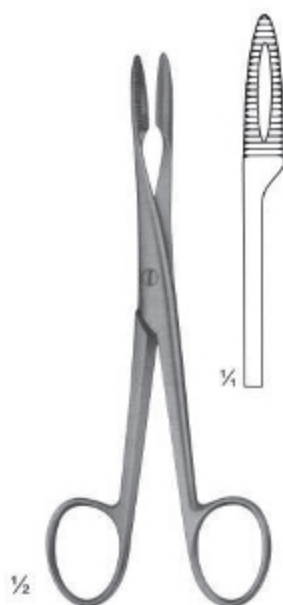

**2548**  
Without Ratchet  
145 mm

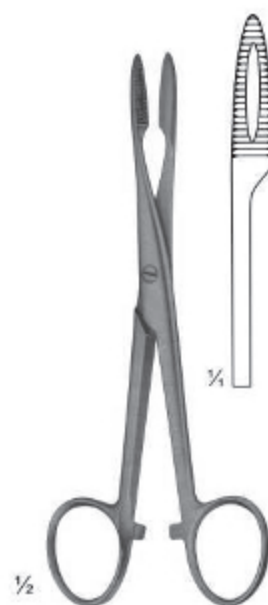

**2549**  
With Ratchet  
145 mm



**2550**  
CRILE  
140 mm

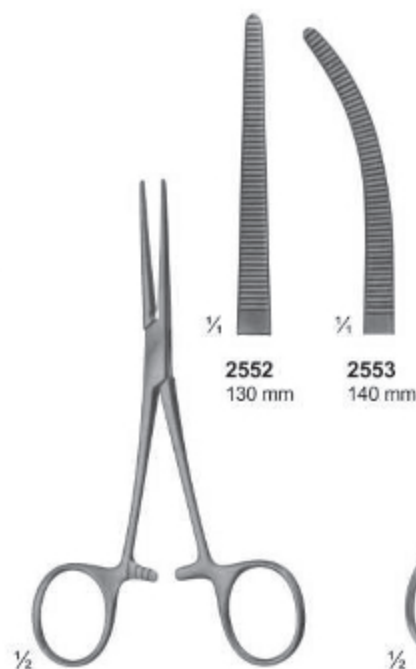

**2551**  
PEAN  
Slender type

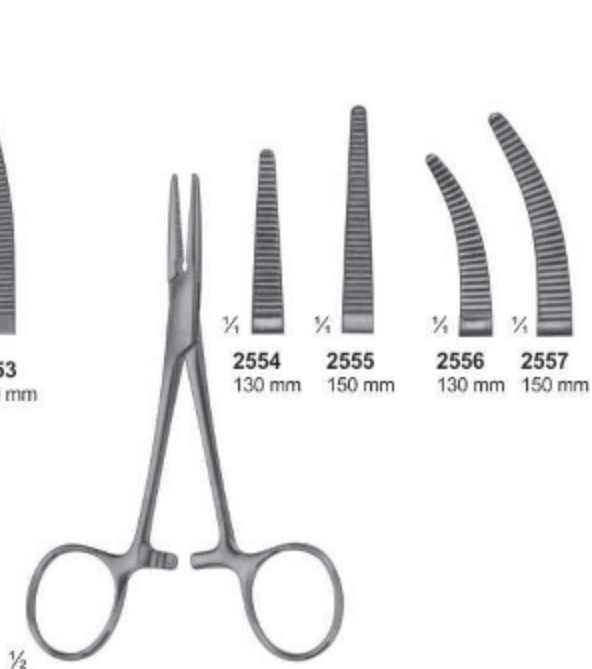

**2554**  
SPENCER-WELLS



**Tissue Forceps**

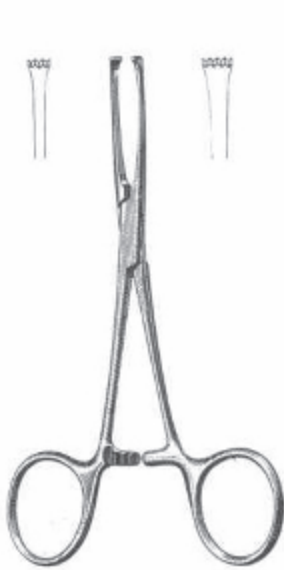

**2558**  
BABY-ALLIS  
5", Straight  
4x5 teeth extra delicate



**2559**  
ALLIS  
6", Straight  
4x5 teeth extra delicate

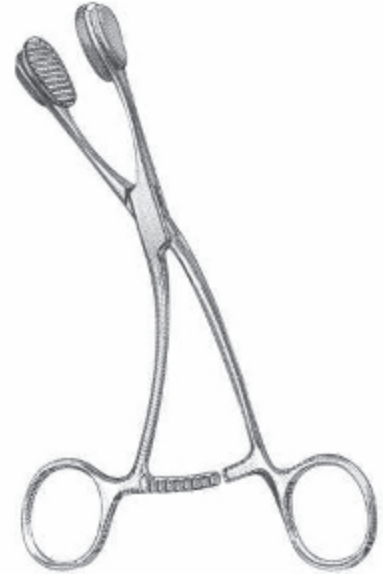

**2560**  
ALLIS  
6", Straight  
4x5 teeth extra delicate



**2561**  
1x2 teeth  
6"



**2562**  
SEMKIN  
6", Straight,  
1x2 teeth



**2563**  
ADSON  
4 3/4"  
1x2 teeth



**2564**  
BROWN-ADSON  
4 3/4"  
7x7 teeth



**2565**  
BROWN  
6"  
8x8 teeth



**2566**  
RUSSIAN  
6"  
8x8 teeth



**2567**  
Extra-Delicate,  
Straight, 4"  
1x2 teeth

## Hemostatic Forceps, Towel Clamps, Napkin Holders



**2568**  
**HALSTED-MOSQUITO**  
 Straight, Curved, 5"



**2569**  
**HALSTED-MOSQUITO**  
 Straight, Curved, 5"  
 1x2 teeth



**2570**  
**HALSTED-MOSQUITO**  
 Jaws 45 Angled on Flat, 5"  
 Extra Delicate



**2571**  
**KELLY**  
 5 1/2", Straight



**2572**  
**JONES**  
 3 1/2"



**2573**  
**BACKHAUS**  
 3 1/2"



**2574**  
**BACKHAUS**  
 5 1/4"



**2575**  
**LORNA**  
 Non Perforated  
 3 1/2"

**Retractors, Depressors, Mouth Gags**

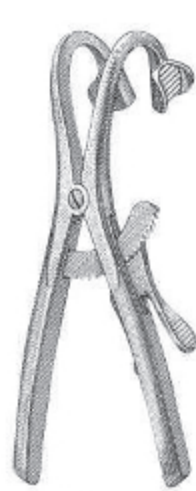

**2576**  
DENHART



**2577**  
DENHARDT  
Mouth Gag With  
Silicon Inserts,  
Interchangeable  
Size: 125 mm

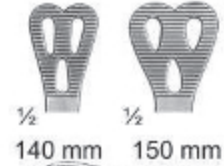

1/2 1/2  
140 mm 150 mm



**2578**  
WIEDER  
Tongue depressor  
**2579** 140mm  
**2580** 150mm

**2581**  
TOBOLD  
Tongue depressor  
Size: 145 mm

**2582**  
ANDREW  
Tongue depressor  
Size: 110 mm

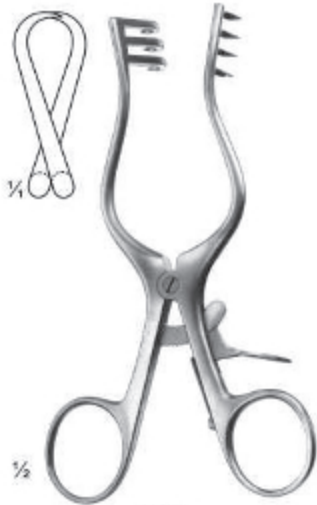

**2583**  
WEITLANER  
Sharp  
130 mm



**2584**  
WEITLANER  
Sharp  
110 mm



**2585**  
WEITLANER  
Semi-Sharp  
110 mm



**2586**  
MOLT  
Pediatric



**2587**  
MOLT  
Child



**2588**  
MOLT  
Adult



**2589**  
FERGUSON-ACKLAND  
Mouth Gag  
Size: 145 mm



**2590**  
ROSER KOENIG  
Mouth Gag  
Size: 160mm / 185mm



# SECTION 07

**SEASONED**  
*Take away the Beauty*  
Since 1985

- ▶ Orthodontic Pliers
- ▶ Orthodontic Cutters
- ▶ Rongeurs
- ▶ Needle Holders

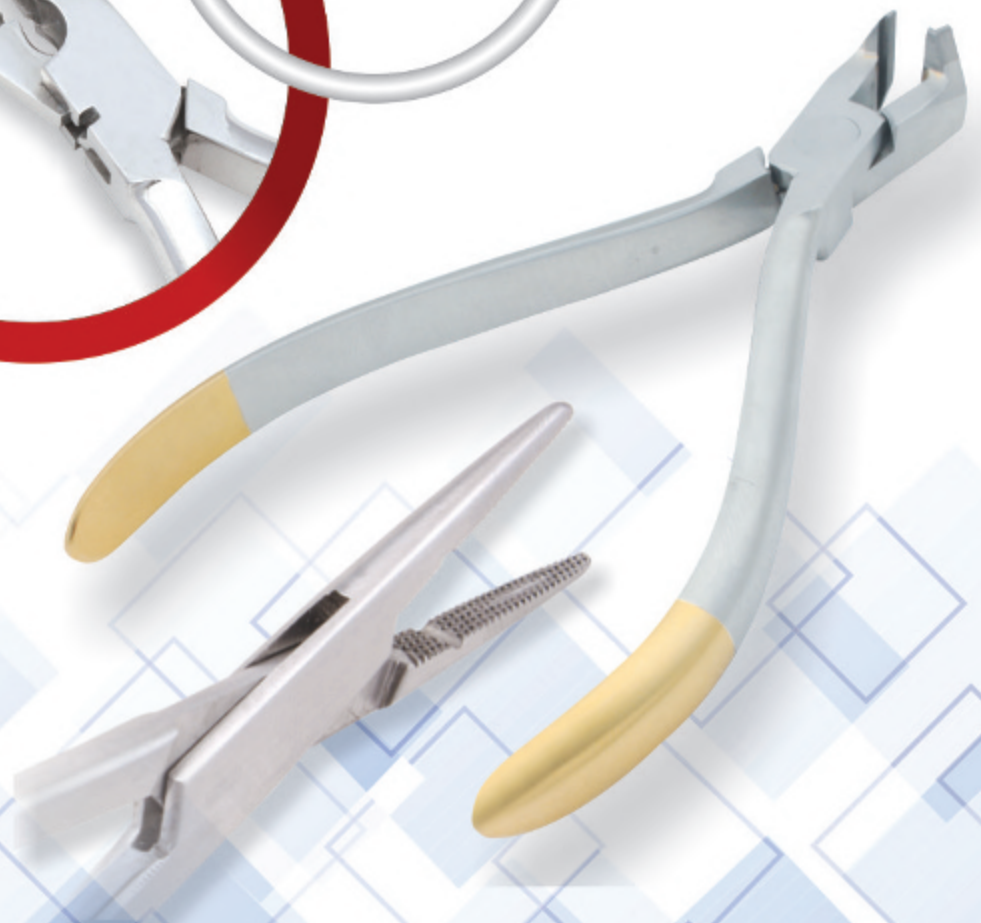



**Lip & Cheek Retractors**

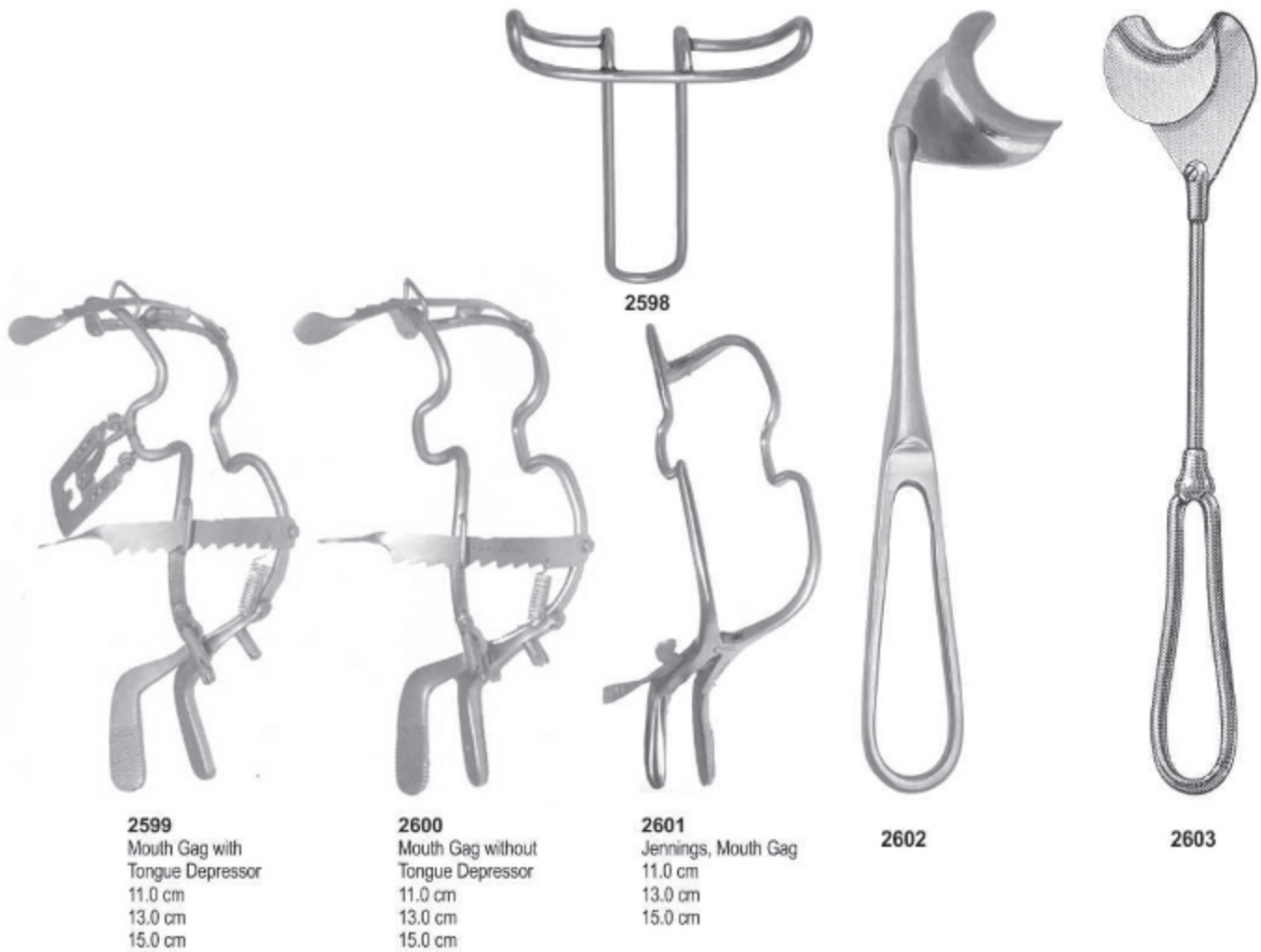

## Lip & Cheek Retractors

- 30 x 4 mm A
- 23 x 7 mm B
- 24 x 11 mm C
- 29 x 10 mm D
- 30 x 11 mm E
- 32 x 14 mm F
- 40 x 11 mm G
- 42 x 10 mm H
- 50 x 11 mm I
- 55 x 11 mm J
- 60 x 11 mm K
- 70 x 11 mm L
- 70 x 14 mm M



**2604**  
 LANGENBECK  
 210 mm



**2605**  
 KOCHER-LANGENBECK  
 215 mm



**2606**  
 BUCHS  
 205 mm



38 x 18 mm



**2607**  
 KOCHER  
 230 mm



**2608**  
 MIDDELDORPF



**2609**  
 15 x 15 mm  
 220 mm



**2610**  
 20 x 22 mm  
 215 mm



**2611**  
 28 x 28 mm  
 235 mm



**2612**  
 KOCHER  
 230 mm



**2613**  
 COLLIN  
 150 mm



**2614**  
 ROUX  
 Set  
 165 mm

**Sterilizing Forceps**



**2615**  
 Sterilizing Forcep Curved  
 20 cm A  
 25 cm B  
 30 cm C



**2616**  
 Sterilizing Forcep Straight  
 20 cm A  
 25 cm B  
 30 cm C



**2617**  
 Sterilizing Forcep  
 30 cm



**2618**  
 Becht Tweezer



**2619**  
 Sterilizing Forcep  
 23 cm A  
 30 cm B



**2620**  
 Sterilizing Forcep  
 20 cm



**Tissue Retractors & Hooks**



**2621**  
3 sharp prongs



**2622**  
2 sharp prongs  
6"



**2623**  
2 sharp prongs  
6"



**2624**  
FOMON  
145 mm



**2625**  
ALM  
70 mm



**2626**  
SENN  
3 sharp prongs  
6 3/8"



**2627**  
TOENNIS  
Dura Retractor  
150mm



**2628**  
JOSEPH  
165 mm



**2629**  
GILLIES  
180 mm



**Orthodontic Pliers**



**2630**  
Light Wire Cutter



**2631**  
Wire Cutter



**2632**  
Posterior Band Remover  
Long



**2633**  
Posterior Band Remover  
Short



**2634**  
Jarabak Plier  
Short



**2635**  
Distal End Cutter  
Safety End Cutter



**2636**  
Distal End Cutter



**2637**  
Kim's Plier



**2638**  
Loop Forming Plier



**2639**  
Tweed Arch Bending Plier



**2640**  
Utility Plier



**2641**  
Bonding Bracket Remover



**2642**  
Lingual Arch Plier



**2643**  
Light Wire Plier



**2644**  
Wire Cutter  
12.5 cm

**Orthodontic Pliers**



**2645**  
 Fig. 101  
 Wire Bending

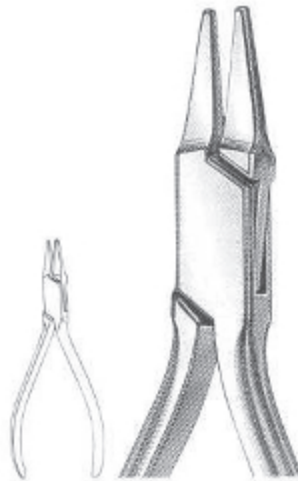

**2646**  
 Fig. 118  
 PEESO  
 Collar

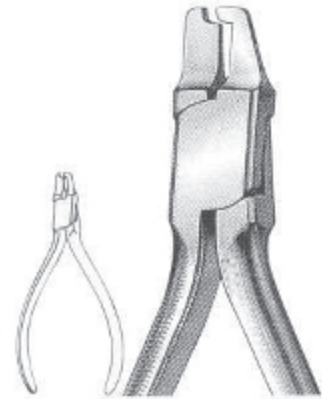

**2647**  
 Fig. 417  
 Crown Shell

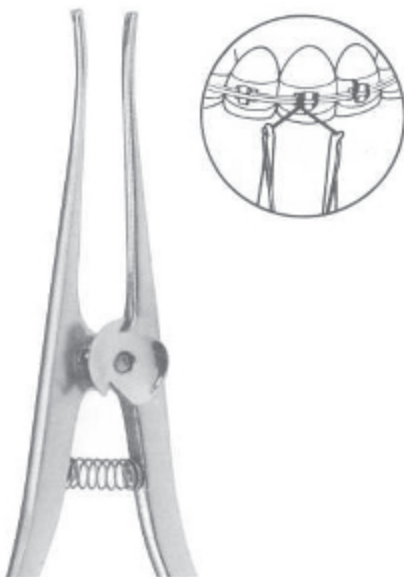

**2648**  
 STEINER  
 150 mm  
 Ligature Pliers

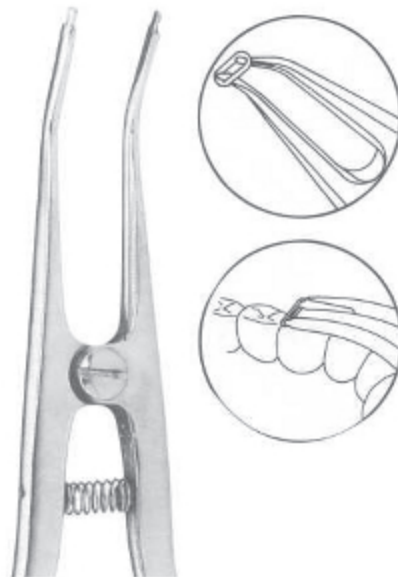

**2649**  
 Separating Pliers Elastics  
 150 mm

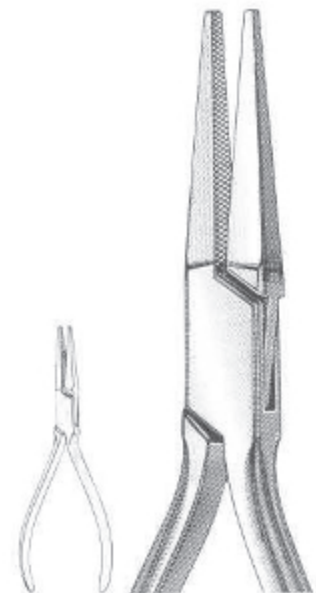

**2650**  
 121-Lab & Office

## Orthodontic Pliers



**2651**  
 How Plier-Titanium Alloy  
 With special coated beaks



**2652**  
 How Plier  
 Tips are 1/8"(3.2mm)  
 diameter



**2653**  
 How Plier  
 Tips are 1/8"(3.2mm)  
 diameter



**2654**  
 How Plier-Small  
 Tips are 3/32"(2.4mm)  
 diameter



**2655**  
 How Plier-Offset  
 Tips are 1/8"(3.2mm)  
 diameter



**2656**  
 Weingart Utility Plier  
 -Titanium Alloy  
 with special coated beaks

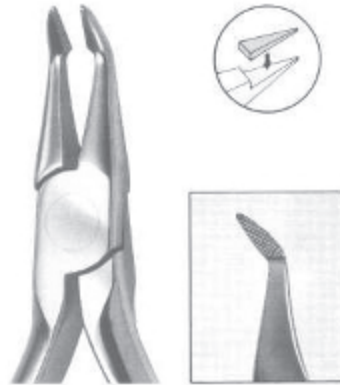

**2657**  
 Weingart Utility Plier  
 New type of the Weingart Utility Plier  
 designed for a more precise operation.



**2658**  
 Weingart Utility Plier

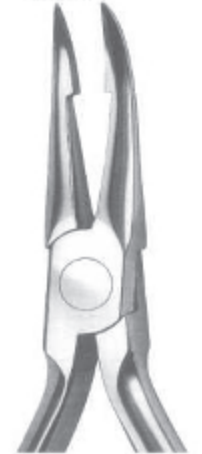

**2659**  
 Weingart Utility Plier

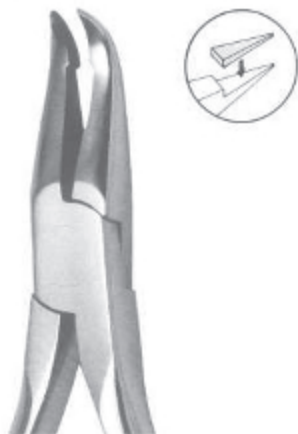

**2660**  
 Weingart Utility Plier

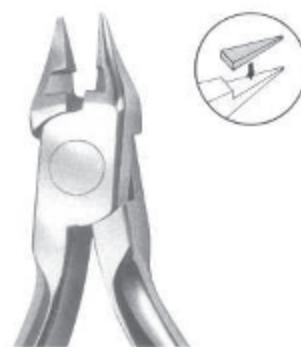

**2661**  
 Bird Beak Plier With Cutter  
**Maximum Bending &  
 Cutting Capacity:**  
 Wires up to .032"



**2662**  
 Bird Beak Plier  
**Maximum Bending Capacity:**  
 Wires up to .032"



**2663**  
 Bird Beak Plier  
**Maximum Bending  
 Capacity:**  
 Wires up to .030"

## Orthodontic Pliers



**2664**  
TWEED (Fig. 98)  
13 cm, 5 1/8"  
Tweed Loop Omega Pliers.



**2665**  
TWEED - (Fig. 90)  
14 cm, 5 1/2"



**2666**  
O'BRIEN - (Fig. 97)  
14 cm, 5 1/2"



**2667**  
TWEED (Fig. 96)  
14 cm, 5 1/2"



**2668**  
TWEED (Fig. 95)  
13.5 cm, 5 1/4"

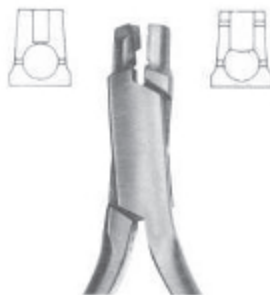

**2669**  
SCHWARZ (Fig. 29)  
12.5 cm, 5"



**2670**  
NANCE (Fig. 80)  
13 cm, 5 1/8"

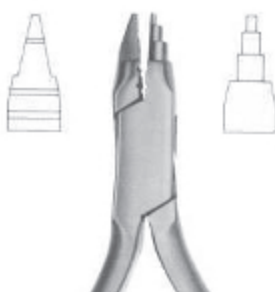

**2671**  
YOUNG (Fig. 55)  
13 cm, 5 1/8"



**2672**  
SCHWARZ (Fig. 30)  
13 cm, 5 1/8"



**2673**  
Optical Plier (Fig. 53)  
14 cm, 5 1/2"

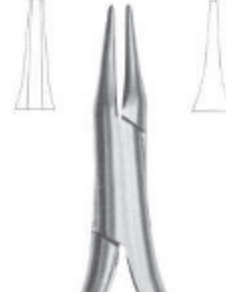

**2674**  
Schwarz (Fig. 79)  
13.5 cm, 5 1/4"



## Orthodontic Pliers



**2675**  
NANCE (Fig. 56)  
12.5 cm, 5"  
Wire bending Pliers



**2680**  
14.0 cm  
Goslee Contouring Plier



**2676**  
JOHNSON (Fig. 59)  
13.5 cm, 5 1/4"  
Contouring Plier.



**2678**  
De La Rosa (Fig. 34)  
12.5 cm, 5"  
Contouring Plier, Non-Grooved



**2677**  
REYNOLDS (Fig. 61)  
13 cm, 5 1/8"  
Contouring Plier.



**2679**  
De La Rosa (Fig. 35)  
12.5 cm, 5"  
Contouring Plier, Grooved



**2681**  
14.0 cm  
Goslee Contouring Plier



**2682**



**2683**  
Fig. 58  
12.5 cm, 5"  
Lingual Arch Bending Plier



**2684**  
Frevert/Tweed (Fig. 51)  
12.5 cm, 5"  
Tweed Arch Plier/Standard Jaw



**2685**



**2686**  
ANGLE (Fig. 52)  
13 cm, 5 1/8"  
Arch Forming Plier

## Orthodontic Pliers



**2687**  
Fig. 60  
13 cm, 5 1/8"  
Wire & Clasp Bending Pliers



**2688**  
Fig. 60  
13 cm, 5 1/8"  
Wire & Clasp Bending Pliers

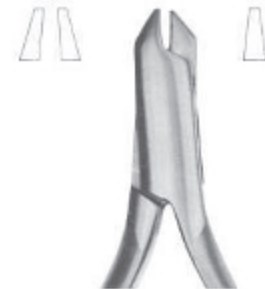

**2689**  
Aderer (Fig. 57)  
12 cm, 4 3/4"  
Wire & Clasp Bending Pliers



**2690**  
49 e 49 TC  
14 cm, 5 1/2"  
Band Removing Plier, short pad



**2691**  
50 e 50 TC  
14 cm, 5 1/2"  
Band Removing Plier, long pad



**2692**  
Fig. 84  
14.5 cm, 5 3/4"  
Band pinshing & ligature  
locking plier, serrated



**2693**  
Fig. 72  
14 cm, 5 1/2"  
Band pinshing & ligature  
locking plier, serrated



**2694**  
BRACKET (Fig. 82)  
13.5 cm, 5 1/4"  
Direct Bonding Bracket Remover



**2695**  
BRACKET (Fig. 83)  
13.5 cm, 5 1/4"  
Direct Bonding  
Bracket Remover

## Orthodontic Pliers



**2696**  
38c, 38TC  
13.5 cm, 5 1/4"  
Contouring closing loop pliers,  
wire bending, cutter.



**2697**  
40c, 40TC  
13.5 cm, 5 1/4"  
Contouring pliers light wire pliers  
grooved with cutter.



**2698**  
Fig. 81  
12.5 cm, 5"  
Sling clasp & wire bending plier



**2699**  
Fig. 28  
14 cm, 5 1/2"  
Sling clasp & wire bending plier.



**2700**  
Fig. 21  
13 cm, 5 1/8"  
Light wires pliers, grooved



**2704**  
46c - 46 TC  
ADAMS - N. 139c  
12.5 cm, 5"  
Bird beak with cutter.



**2701**  
ADAMS, 23, 23TC  
12.5 cm, 5"  
Sling clasp & wire bending plier.



**2702**  
ADAMS (Fig. 33)  
12.5 cm, 5"  
For retaining elements.



**2703**  
ADAMS (Fig. 44)  
12.5 cm, 5"  
Sling clasp & wire bending plier.



**2705**  
Universal Wire Bending  
Pliers (ADAMS) 47 TC, N.64  
12.5 cm, 5"  
Sling clasp & wire bending plier.



**2706**  
86c, 86 TC  
Angle Bird Beak - N.138  
12.5 cm, 5"  
Sling clasp & wire bending plier.

**Orthodontic Distal End Cutters with T.C.**



Ø 1.0 mm  
(0.40")

**2707**  
 Fig. 18 TC  
 15 cm, 6"



Ø 1.0 mm  
(0.40")

**2708**  
 Fig. 92 TC  
 14 cm, 5 1/2"



Ø 0.4 mm  
(0.16")

**2709**  
 Fig. 91 TC  
 13 cm, 5 1/8"



Ø 0.4 mm  
(0.16")

**2710**  
 Fig. 99 TC  
 13 cm, 5 1/8"



Ø 0.4 mm  
(0.16")

**2711**  
 Fig. 94 TC  
 13 cm, 5 1/8"  
 Angled at 15° with or  
 without spring on \  
 the handles.



**2712**  
 Fig. 85 TC  
 13 cm, 5 1/8"



**2713**  
 Fig. 87 TC  
 13 cm, 5 1/8"



**2714**  
 Fig. 85 TC  
 Angled at 15°  
 13 cm, 5 1/8"



**2715**  
 ADAMS 87 TC  
 Angled at 15°  
 13 cm, 5 1/8"



## Orthodontic Distal End Cutters



**2716**  
 Fig. 89 TC



**2717**  
 Fig. 64 TC  
 13 cm, 5 1/8"



**2718**  
 Fig. 67 TC  
 13 cm, 5 1/8"



**2719**  
 Fig. 88 TC  
 13 cm, 5 1/8"



**2720**  
 Fig. 77 TC  
 13 cm, 5 1/8"

**Pliers for Orthodontics & Prosthetics**



**2721**  
 UNIVERSAL  
 150 mm



**2722**  
 WALDSACHS  
 155 mm



**2723**  
 ADERER  
 125 mm



**2724**  
 NANCE  
 125 mm



**2725**  
 REYNOLDS  
 125 mm



**2726**  
 HOW  
 145 mm



**2727**  
 HOW  
 140 mm



**2731**  
 FURRER  
 150 mm



**2728**  
 WALDRON  
 125 mm



**2729**  
 ADAMS  
 125 mm



**2730**  
 ANGLE  
 125 mm



**2732**  
 YOUNG  
 130 mm



**2733**  
 NANCE  
 130 mm

## Pliers for Orthodontics & Prosthetics



**2734**  
LANGEBECK  
125 mm



**2735**  
LANGEBECK  
140 mm



**2736**  
LANGEBECK  
130 mm



**2737**  
PEESO  
125 mm



**2738**  
GOSLEE  
125 mm



**2739**  
FISCHER  
140 mm



**2740**  
FISCHER  
140 mm



**2741**  
JOHNSON  
130 mm



**2742**  
MSY  
130 mm



**2743**  
MC KELLOPS  
155 mm



**2744**  
ANDRESEN  
130 mm



**2745**  
SCHWARZ  
130 mm

# SECTION 08

**SEASONED**  
*Take away the Beauty*  
Since 1985

- ▶ Scissors
- ▶ Impression Trays
- ▶ Articulators
- ▶ Hollow Ware
- ▶ T.C. Instruments





**Rongeurs**



**2746**  
 BLUMENTHAL  
 6", 30°, Standard

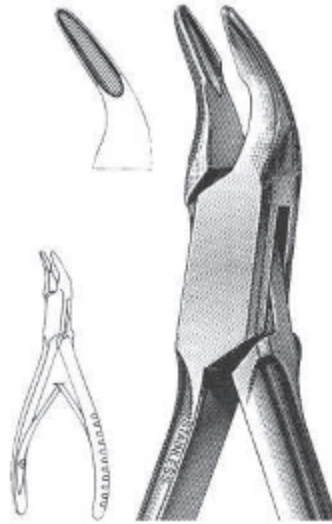

**2747**  
 MINI-BLUMENTHAL  
 6", 45°

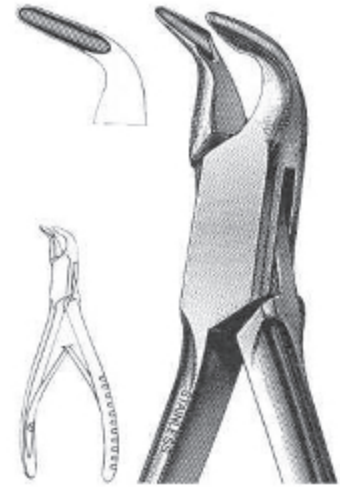

**2748**  
 MINI-BLUMENTHAL  
 6", 90°

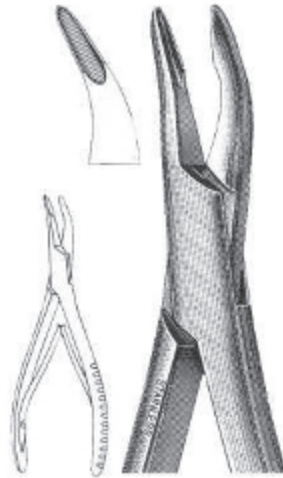

**2749**  
 BLUMENTHAL  
 7", 30°

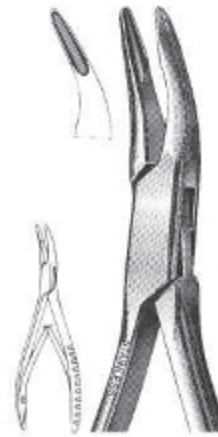

**2750**  
 MINI-BLUMENTHAL  
 4 1/2", 30°

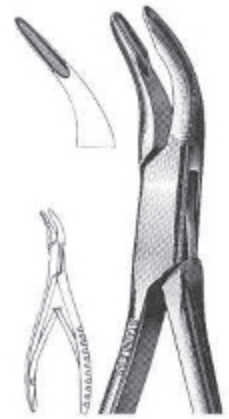

**2751**  
 MINI-BLUMENTHAL  
 4 1/2", 45°

**Rongeurs**



**2752**  
 CLEVELAND  
 No. 5-Side Cutting,  
 6 3/4"

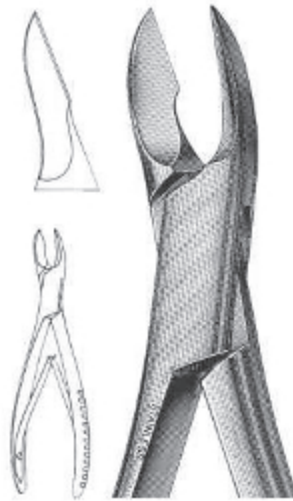

**2753**  
 CLEVELAND  
 No. 5A-Side Cutting,  
 6 1/2"

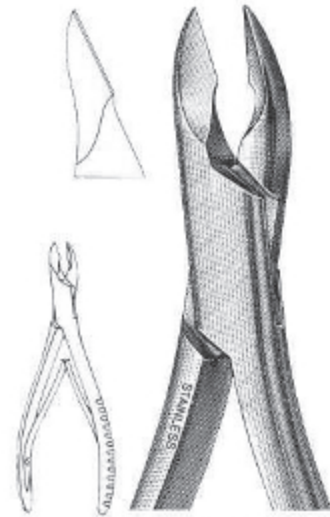

**2754**  
 CLEVELAND  
 No. 5S-Side Cutting,  
 6"

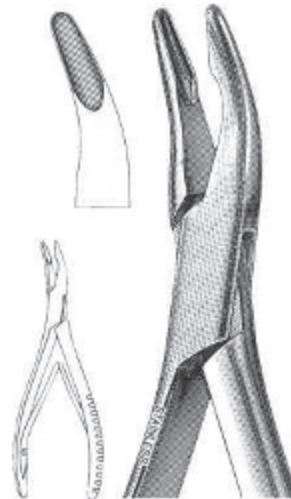

**2755**  
 No. 1A-MEAD  
 6 1/2"

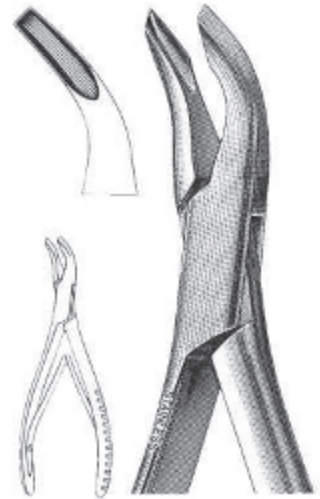

**2756**  
 MEAD, Square  
 No. 2A  
 Tips, 6 1/2"

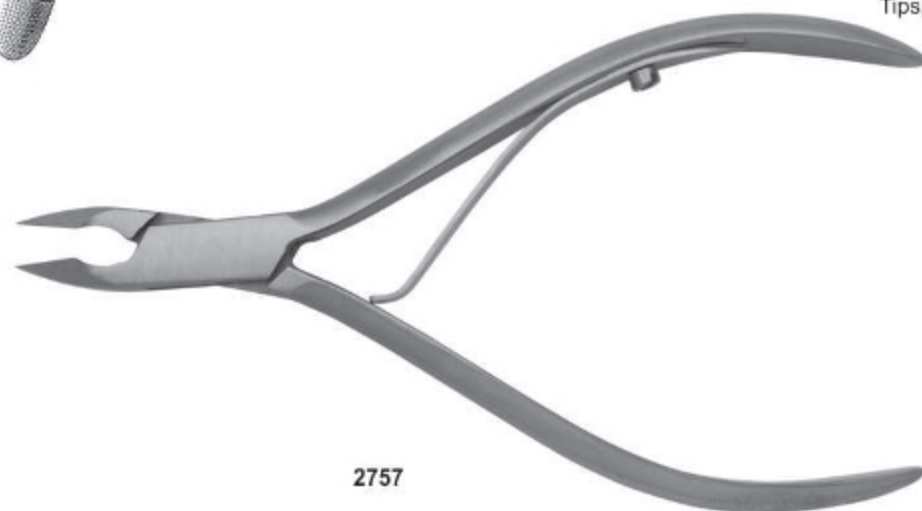

**2757**

**Rongeurs**



**2757**  
 FRIEDMAN  
 5 1/2"

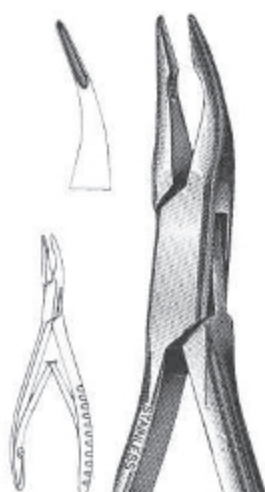

**2758**  
 MICRO-FRIEDMAN  
 5 1/2", 15° Curved Jaws

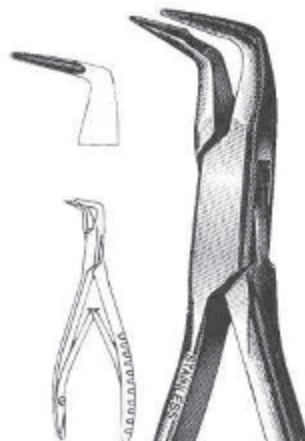

**2759**  
 MICRO-FRIEDMAN  
 Perio Rongeur, 5 1/2"

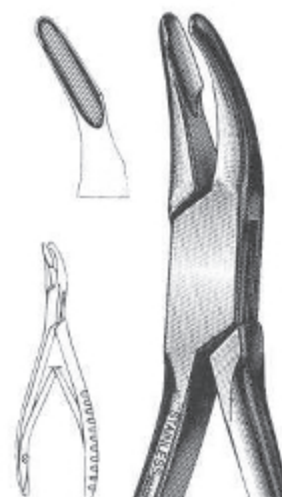

**2760**  
 CLEVELAND  
 No. 4 - 5 1/2"

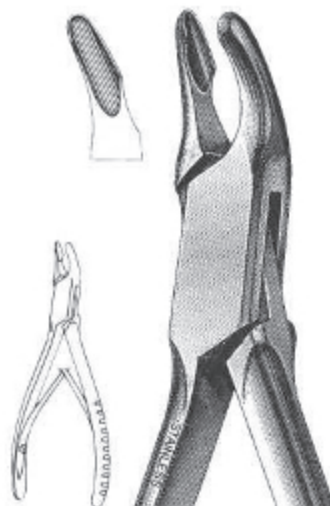

**2761**  
 CLEVELAND  
 No. 4A - 6 1/2"

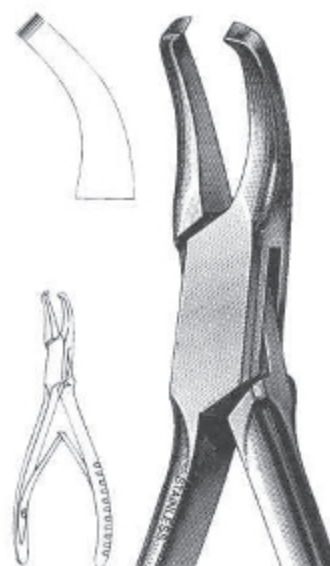

**2762**  
 GARDNER  
 No. 6A, End Cutting  
 6 1/2"



**Rongeurs**



**2763**  
**BEYER**  
 Double Action,  
 16,18 cm



**2764**  
**No. 1**  
 6 1/2"

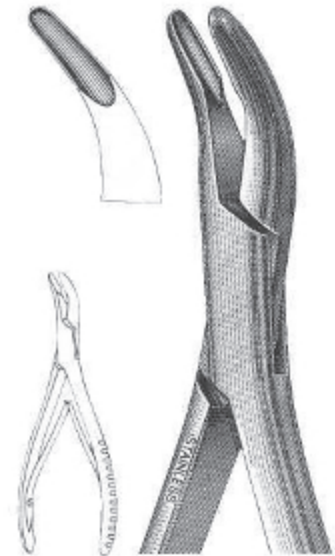

**2765**  
**HARTMAN**  
 5 3/4"  
 Strong Curve

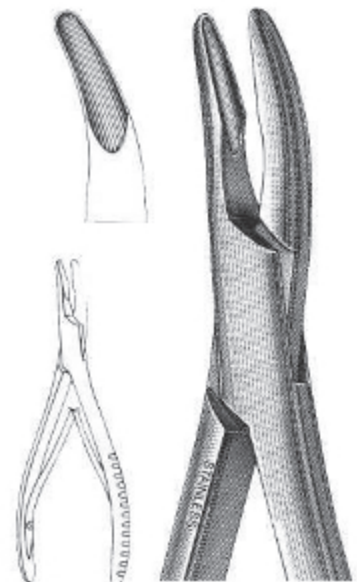

**2766**  
**BANE**  
 Slight Curve  
 7"



**Needle Holders**



**2767**  
**COLLIER**  
 5", Fenestrated Jaws



**2768**  
**DERF**  
 4 3/4"



**2769**  
**WEBSTER**  
 Delicate Smooth Jaws  
 5"



**2770**  
**NEIVERT**  
 One Offset Ring  
 5"



**2771**  
**OLSEN-HEGAR**  
 5 1/2"



**2772**  
**BAUMGARTNER**  
 5 1/2"



**2773**  
**CRILE-WOOD**  
 6"



**2774**  
**GARDNER**  
 5"

## Needle Holders

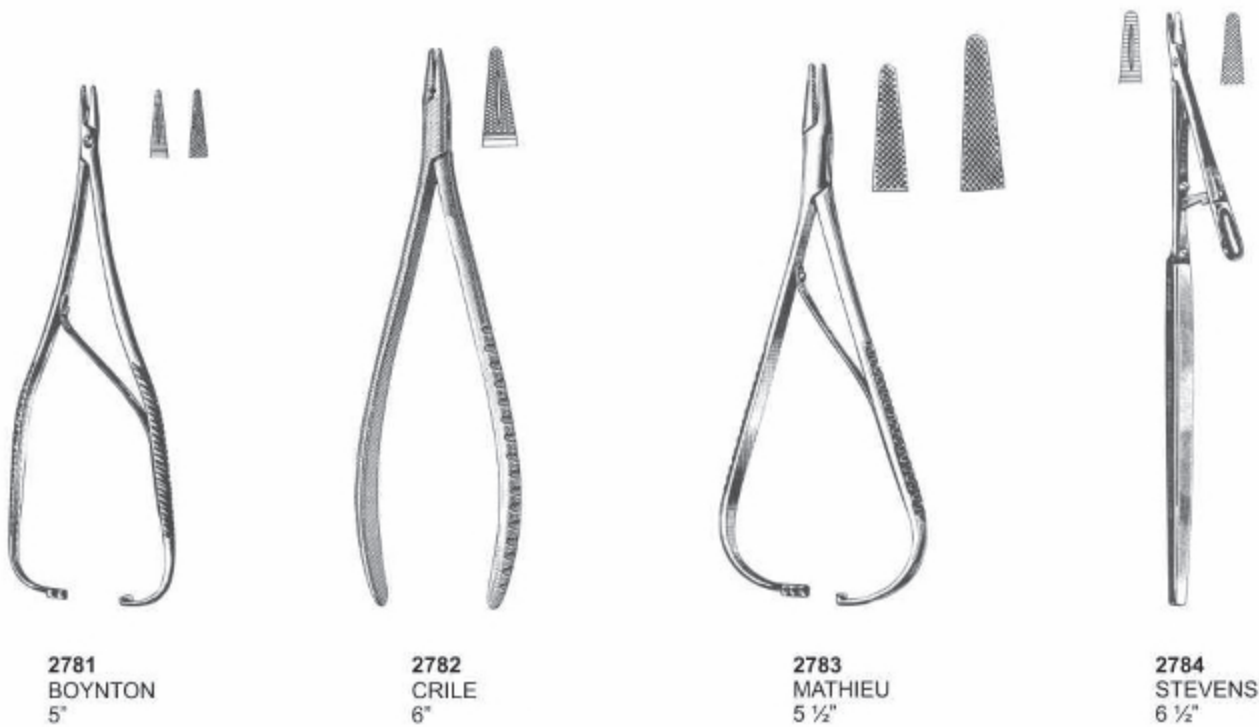
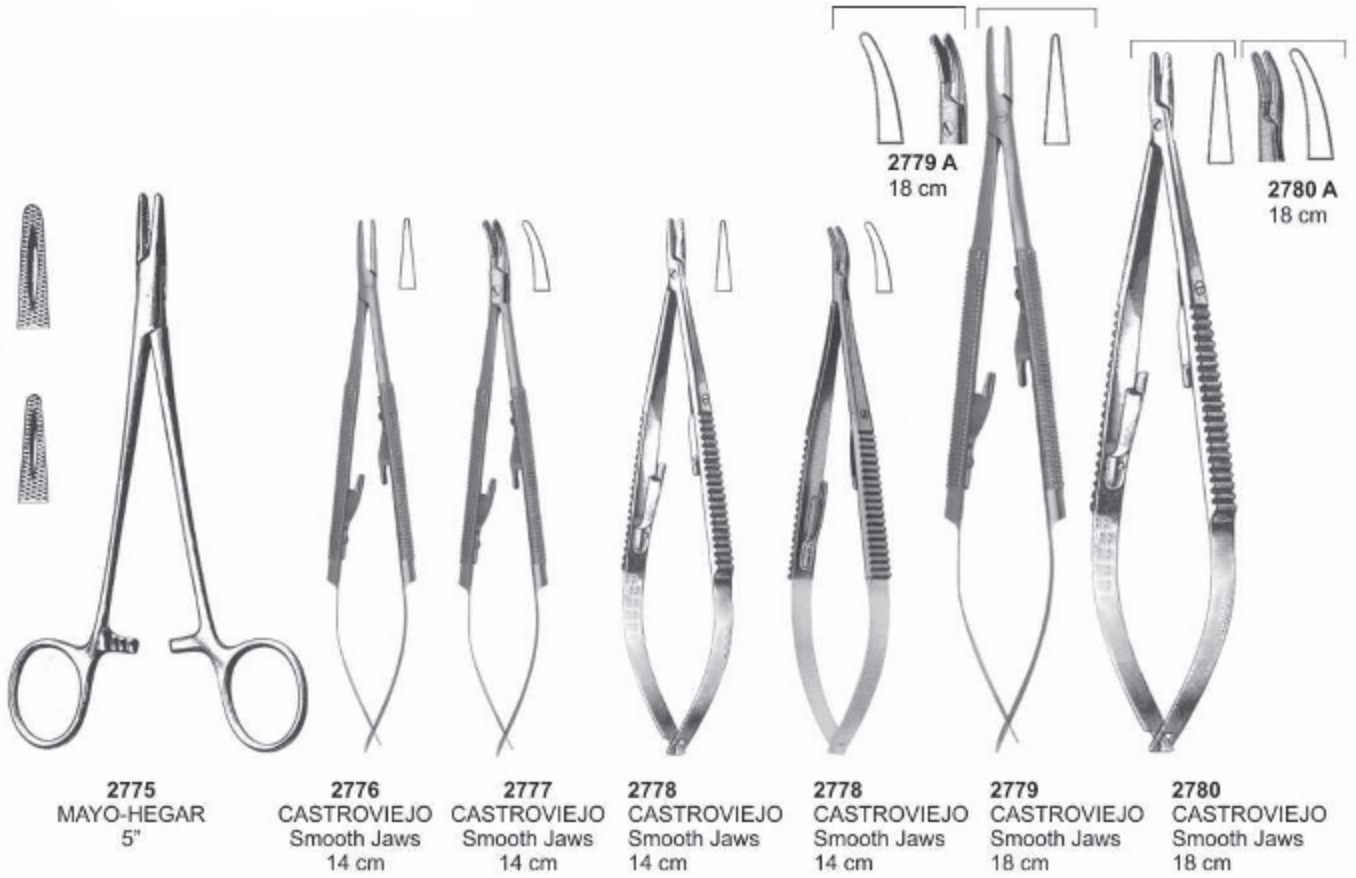

**Micro Surgery Set**



**2785**  
 Micro Scissor  
 Straight, 155 mm



**2786**  
 Micro Scissor  
 Straight, 150 mm



**2787**  
 Micro Scissor  
 Curved, 150 mm



**2788**  
 Micro Scissor  
 Curved, 155 mm



**2789**  
 CASTROVIEJO  
 T.C.  
 Straight, 180 mm



**2790**  
 Retractor  
 Fig.3  
 165 mm



**2791**  
 Micro Adson  
 120 mm



**2792**  
 GERALD  
 Curved,  
 180 mm



**2793**  
 GERALD  
 Straight,  
 175 mm



**2794**  
 Micro Adson  
 160 mm

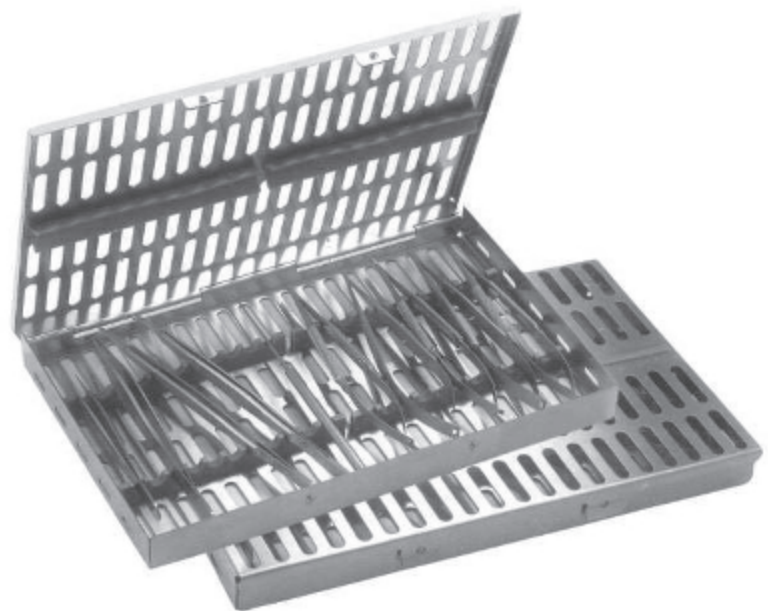

**2795**  
 Micro Surgery Set 10 Pieces.

**Scissors**

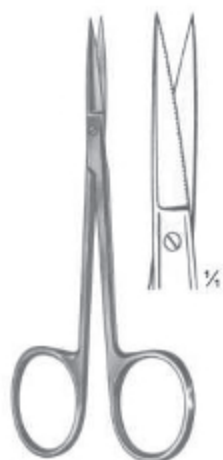

**2796**  
 IRIS (Standard)  
 Straight  
 11.5 cm, 4 1/2"



**2797**  
 IRIS (Standard)  
 Curved  
 11.5 cm, 4 1/2"

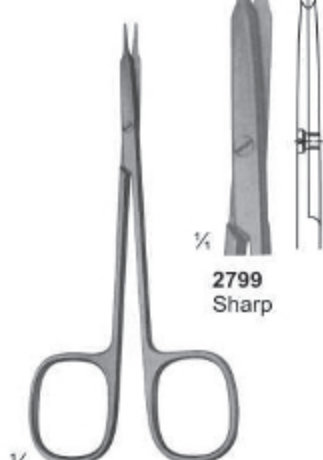

**2798**  
 STEVENS  
 Dissecting Scissors  
 Size: 115 mm



**2799**  
 Sharp



**2800**  
 Sharp



**2801**  
 Blunt



**2802**  
 Blunt



**2803**



**2804**  
 JOSEPH  
 Size: 150 mm

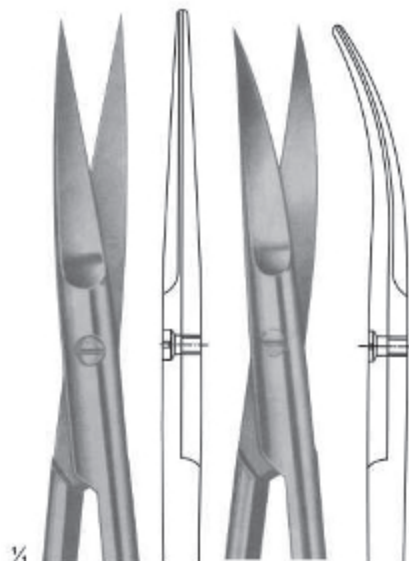

**2805**

**2806**

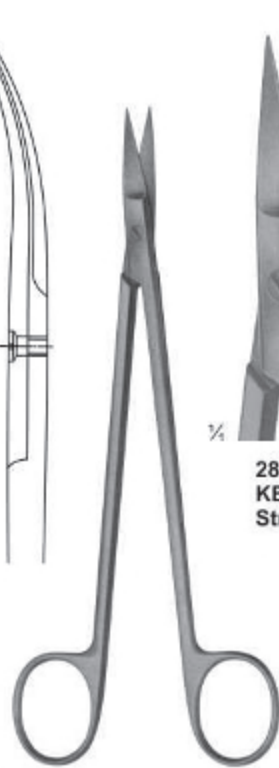

**2807**  
 KELLY  
 Size: 175 mm

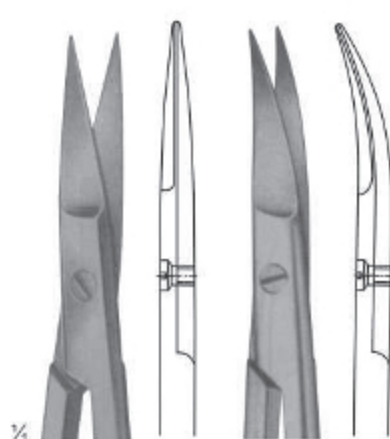

**2808**  
 KELLY  
 Straight

**2809**  
 KELLY  
 Curved

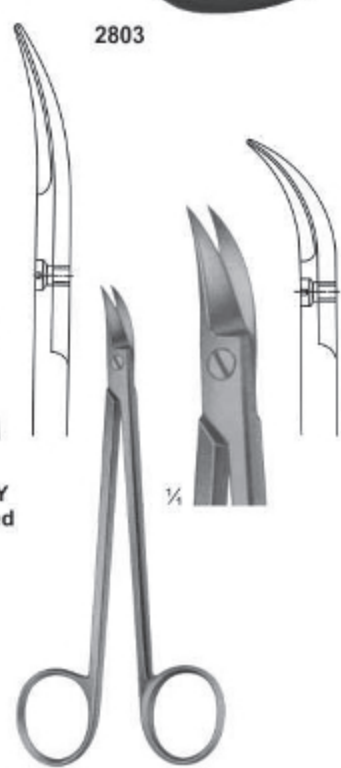

**2810**  
 QUINBY  
 Size: 130 mm



**Scissors**

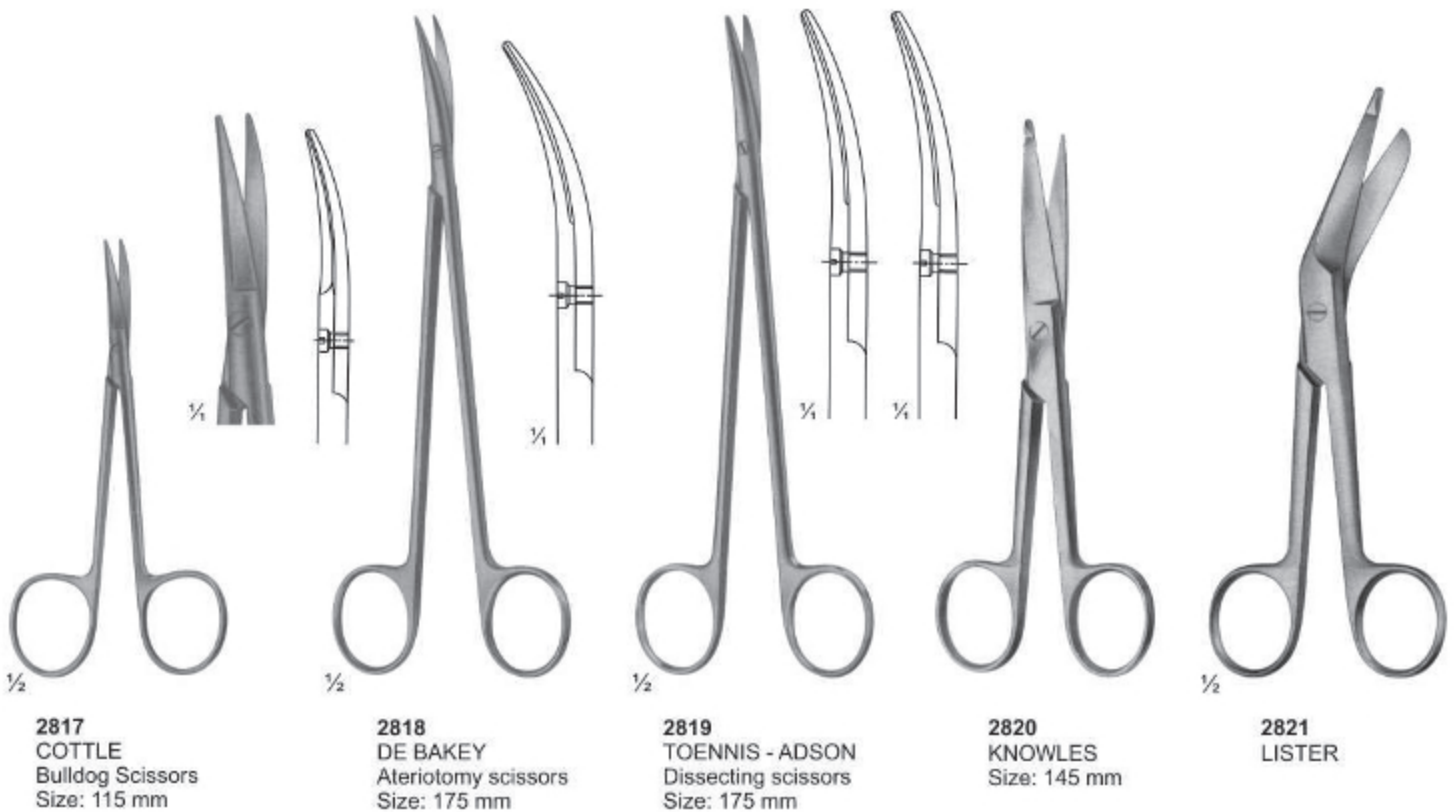
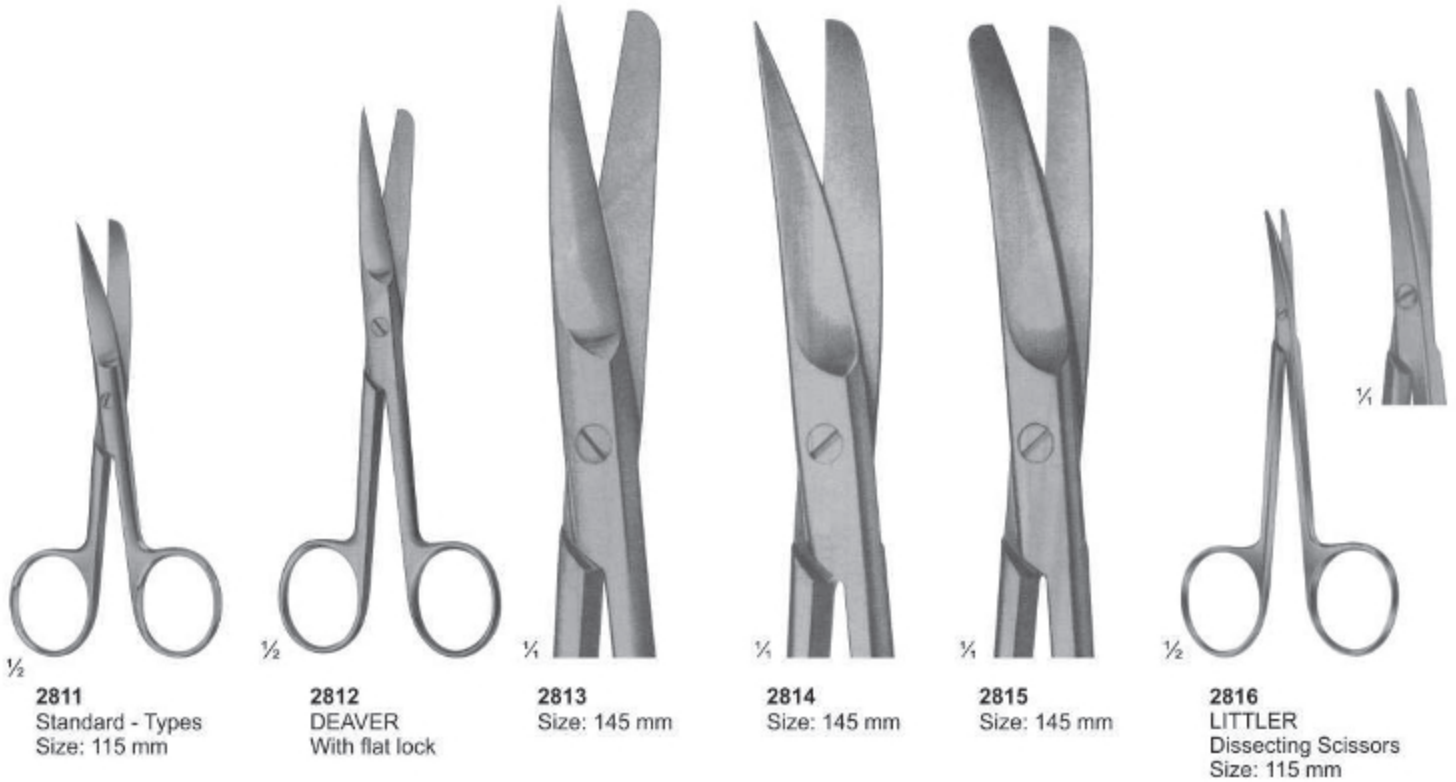

**Scissors**

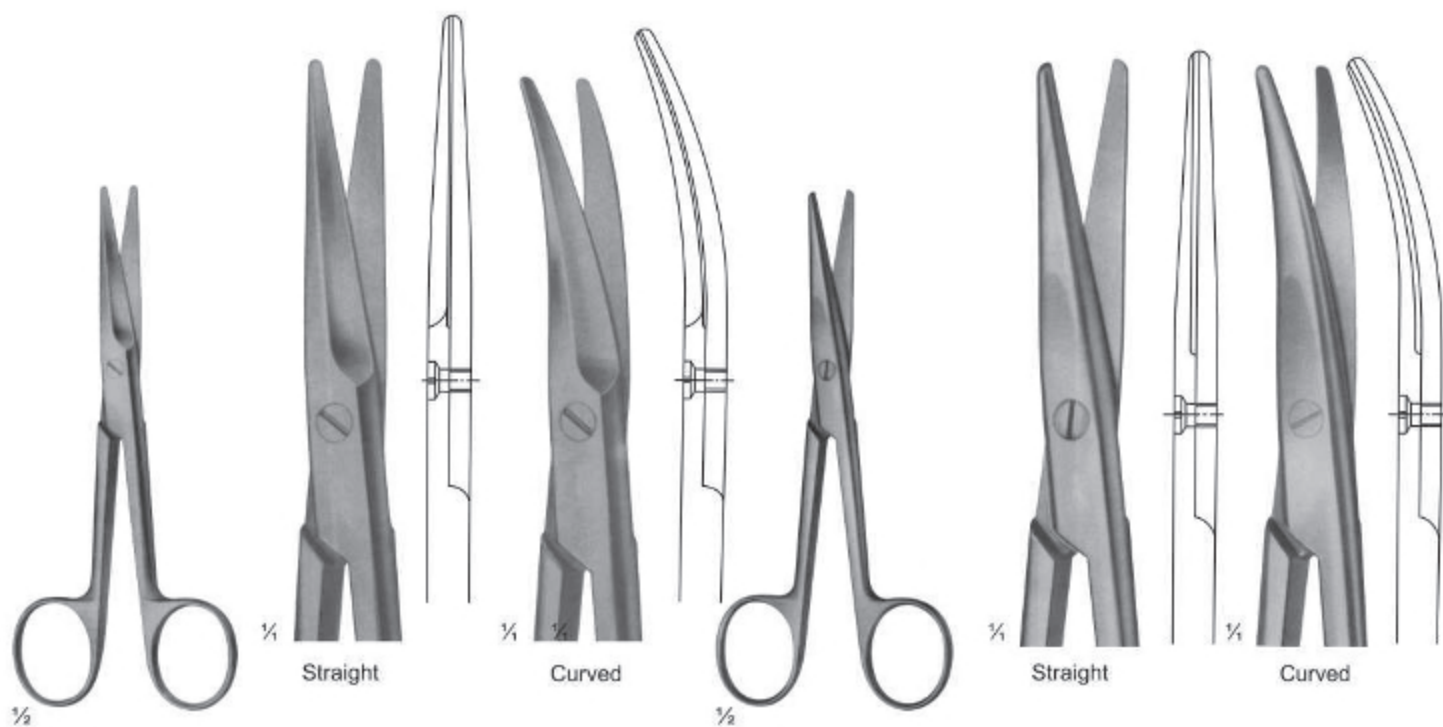

**2822**  
 MAYO(straight)  
 Size: 140 mm

**2823**  
 MAYO-STILLE (straight)  
 Size: 140 mm

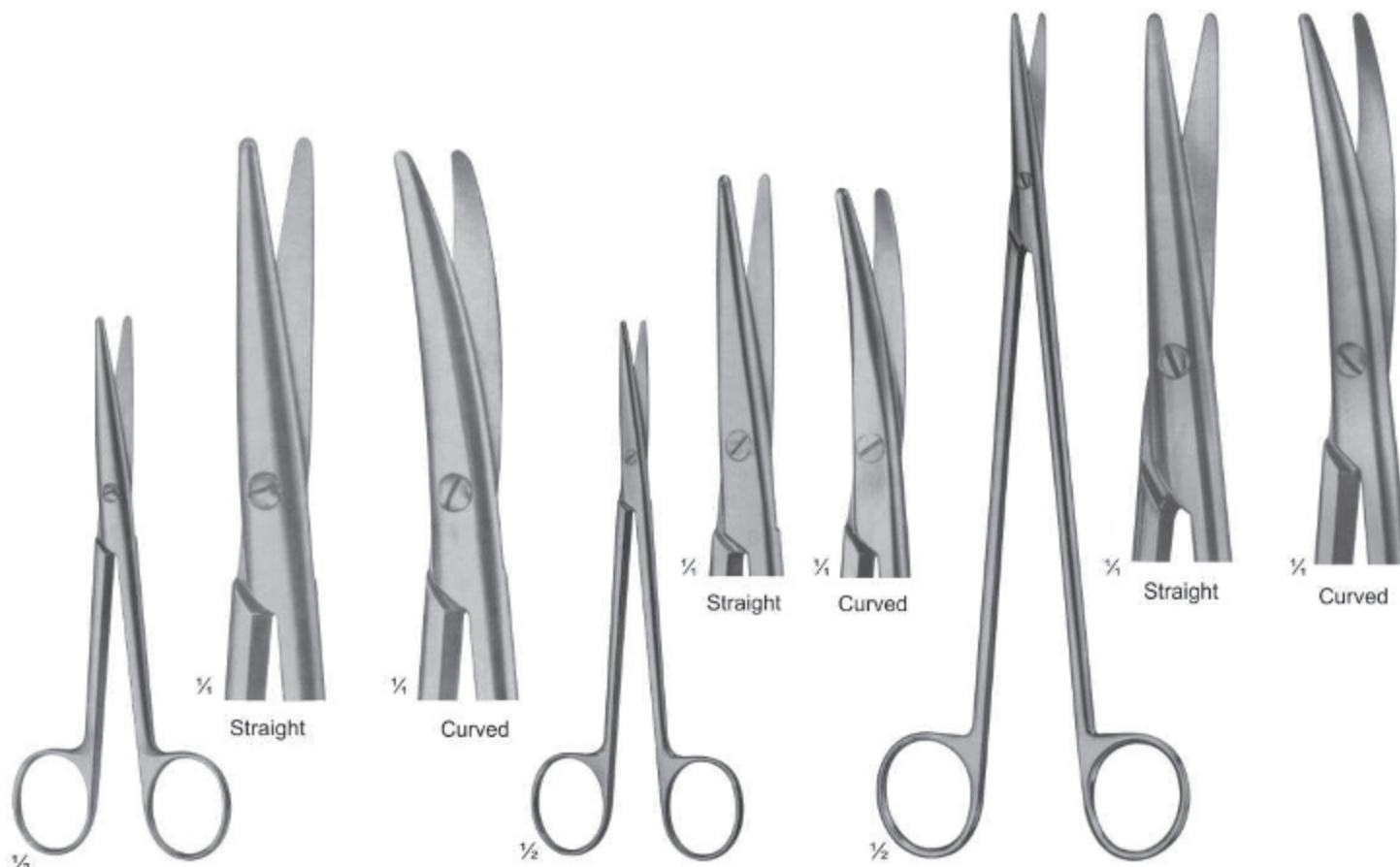

**2824**  
 STILLE  
 Size: 140 mm

**2825**  
 METZENBAUM  
 Size: 145 mm

**2826**  
 NELSON-METZENBAUM  
 Size: 230 mm

**Scissors**

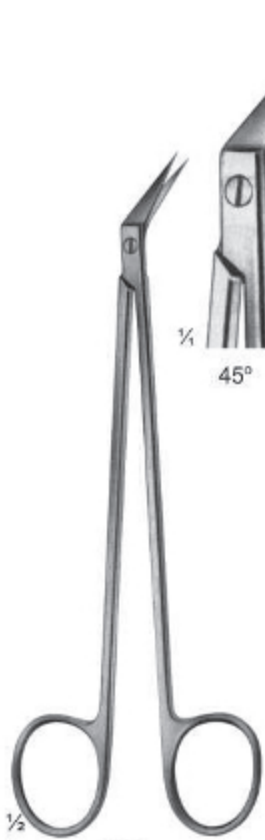

**2827**  
DE BAKEY  
Size: 155 mm

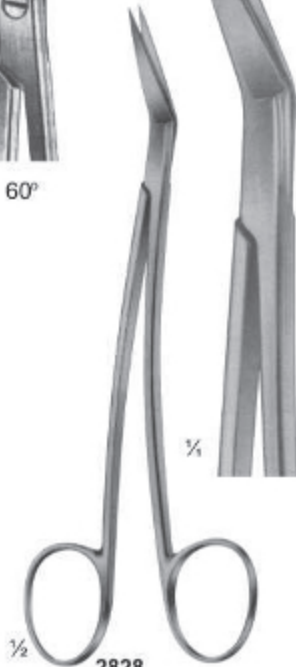

**2828**  
LOCKLIN  
Curved Sideways,  
1 Toothed Blade  
Size: 155 mm



**2829**  
LaGrange  
Double-Curved  
11.5 cm



**2830**  
Goldman-Fox  
Double-Curved  
13cm



**2831**  
SPENCER  
Size: 90 mm

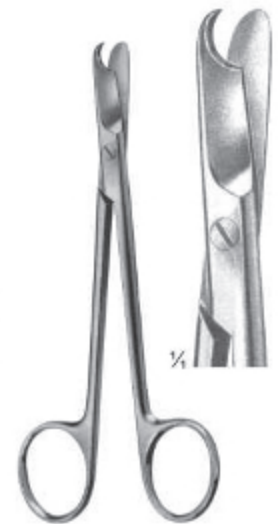

**2832**  
LITTAUER  
Size: 135 mm

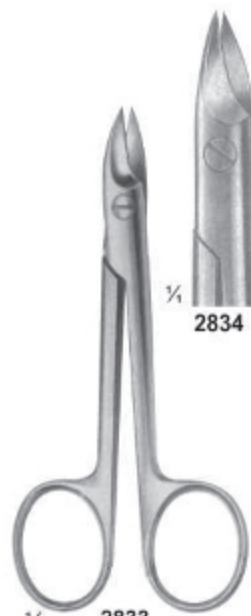

**2833**  
BEEBE  
Size: 110 mm

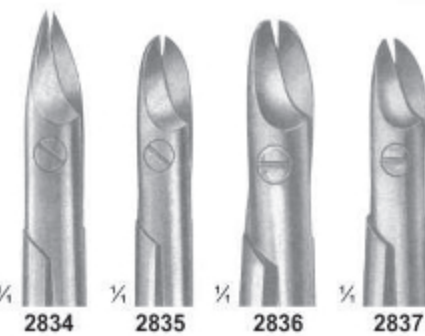

**2834**   **2835**   **2836**   **2837**



**2838**  
Dean  
17cm



**2839**  
1 Blade Serrated  
Size: 120 mm

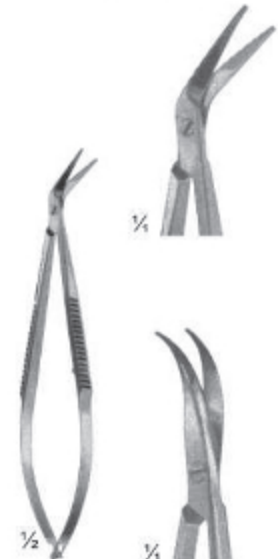

**2840**  
CASTROVIEJO  
Size: 90 mm



## Impression Trays

Made of 18/8 Stainless Steel, Solid, Set of 10

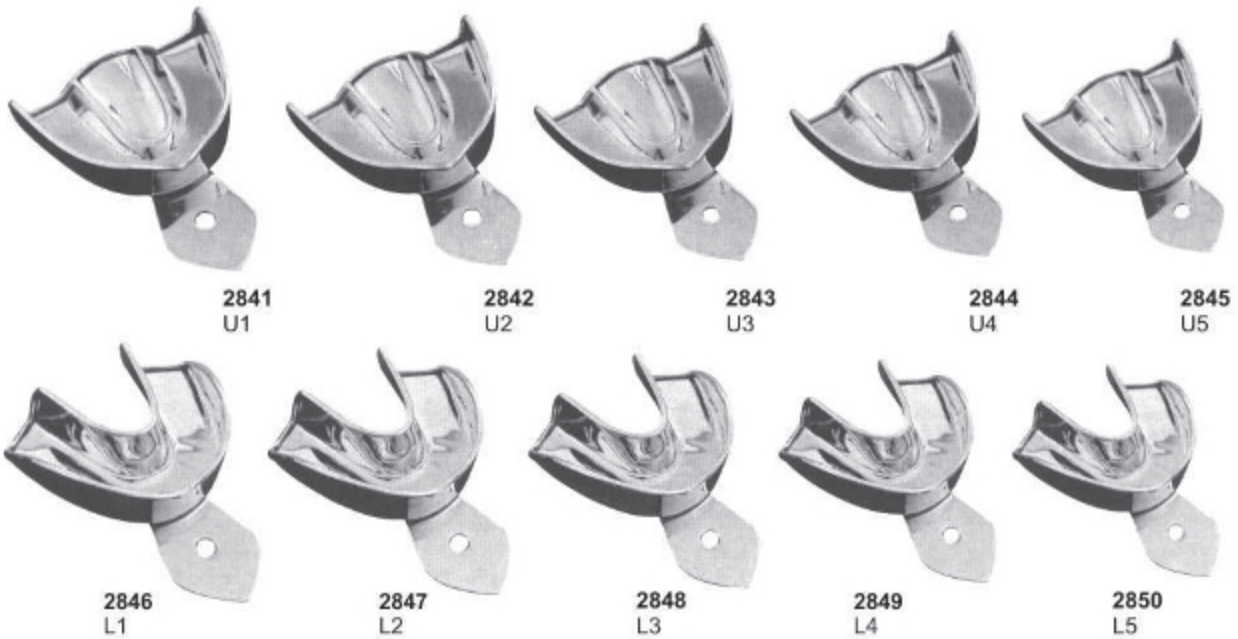

All The Above Impression Trays are Available in These 5 Sizes

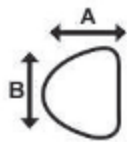

UPPER		U1	U2	U3	U4	U5
	A	62	60	53	54	52
B	83	75	73	69	68	

All Dimension are in mm

LOWER		L1	L2	L3	L4	L5
	A	63	61	57	60	53
B	82	81	78	74	71	

All Dimension are in mm

### Perforated, Set of 10

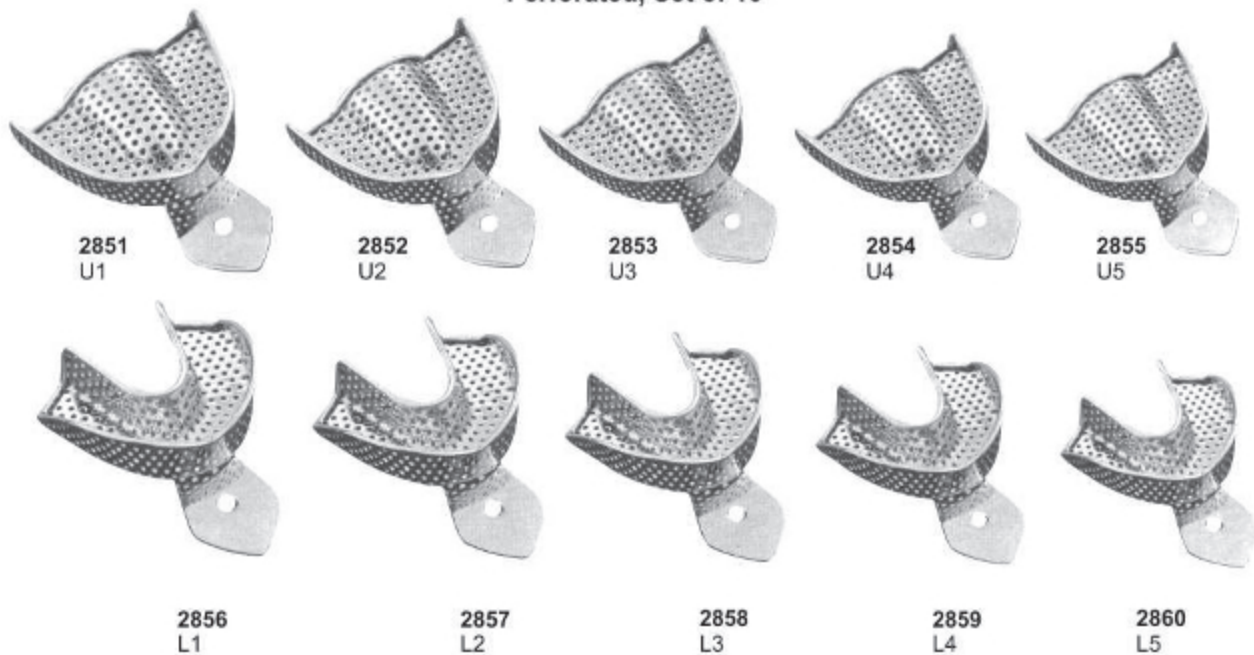



## Impression Trays

Made of 18/8 Stainless Steel, Solid Full Denture Set of 8

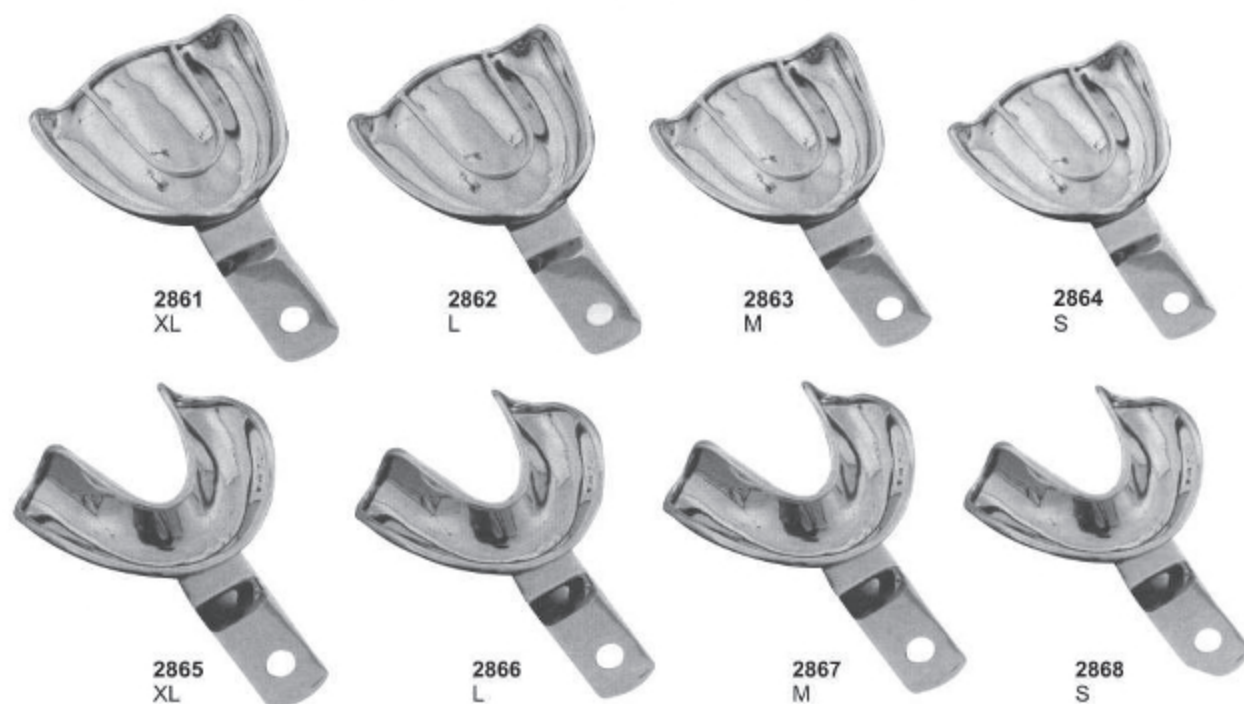

All The Above Impression Trays are Available in These 4 Sizes

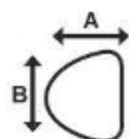

UPPER		XL	L	M	S
	A	70	67	64	60
B	79	76	70	73	

All Dimension are in mm

LOWER		XL	L	M	S
	A	64	64	60	57
B	86	70	73	70	

All Dimension are in mm

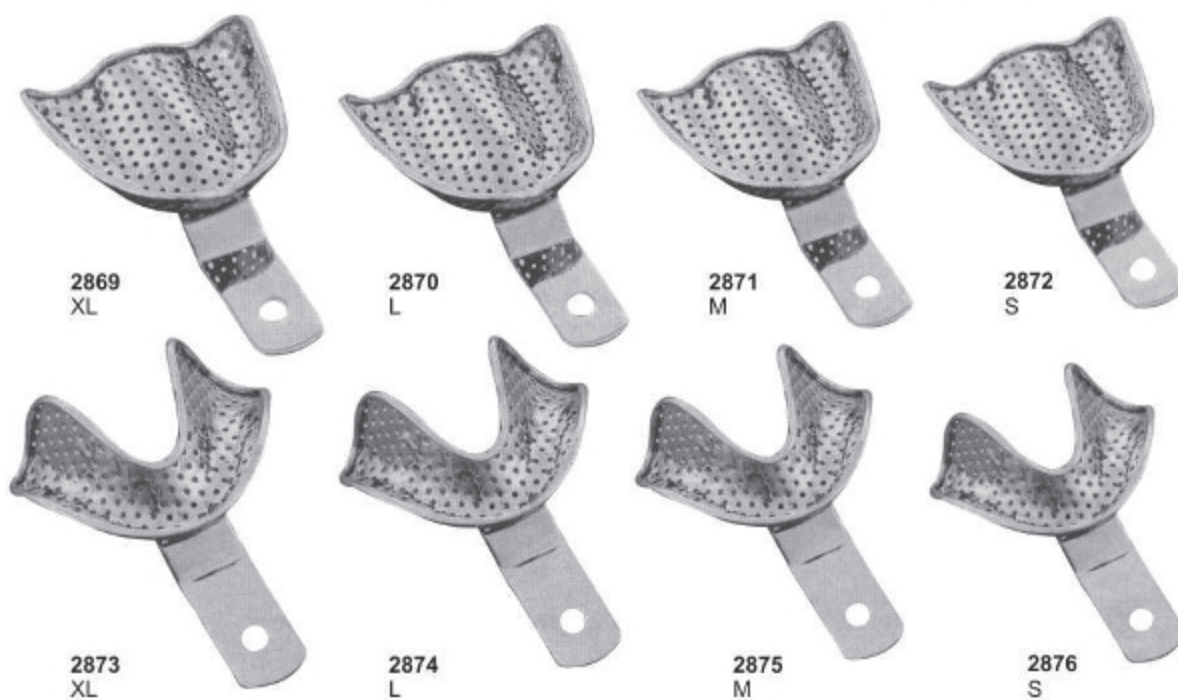

Perforated Full Denture Set of 8

## Impression Trays

Made of 18/8 Stainless Steel, Solid Set of 6

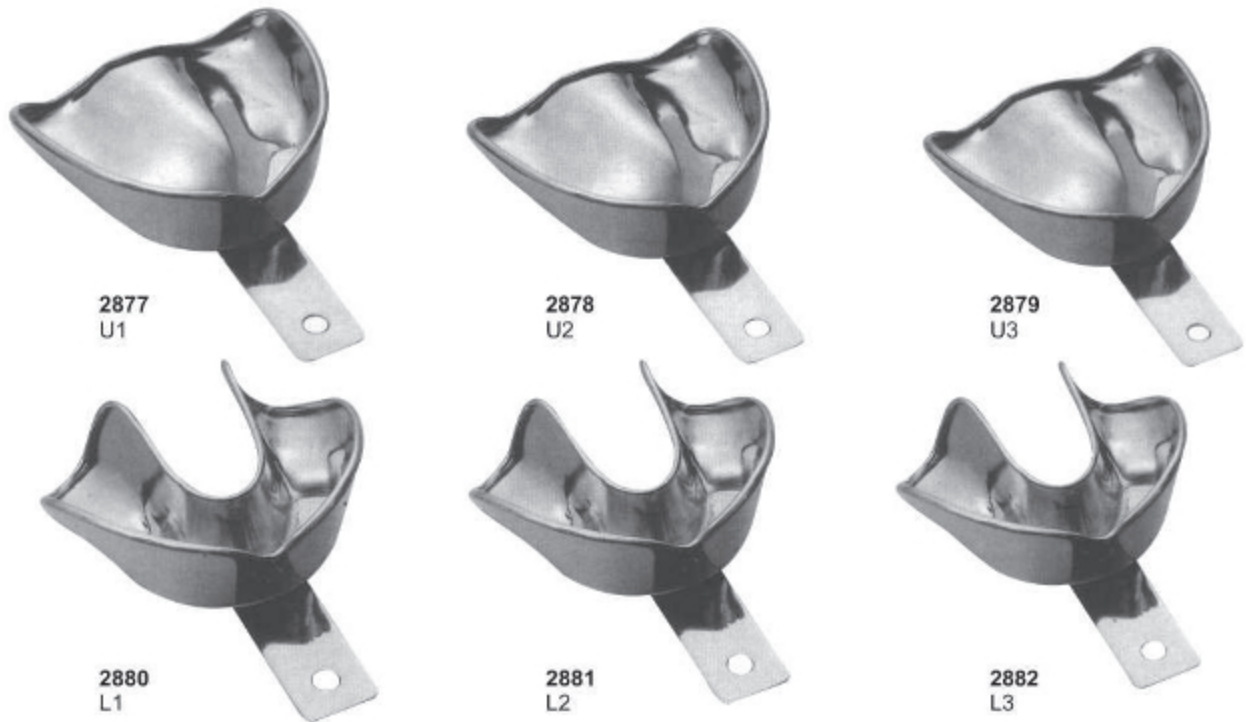

All The Above Impression Trays are Available in These 4 Sizes

UPPER		U1	U2	U3	LOWER		L1	L2	L3
	A	67	64	57		A	60	57	54
B	81	71	70	B	81	79	76		

All Dimension are in mm

All Dimension are in mm

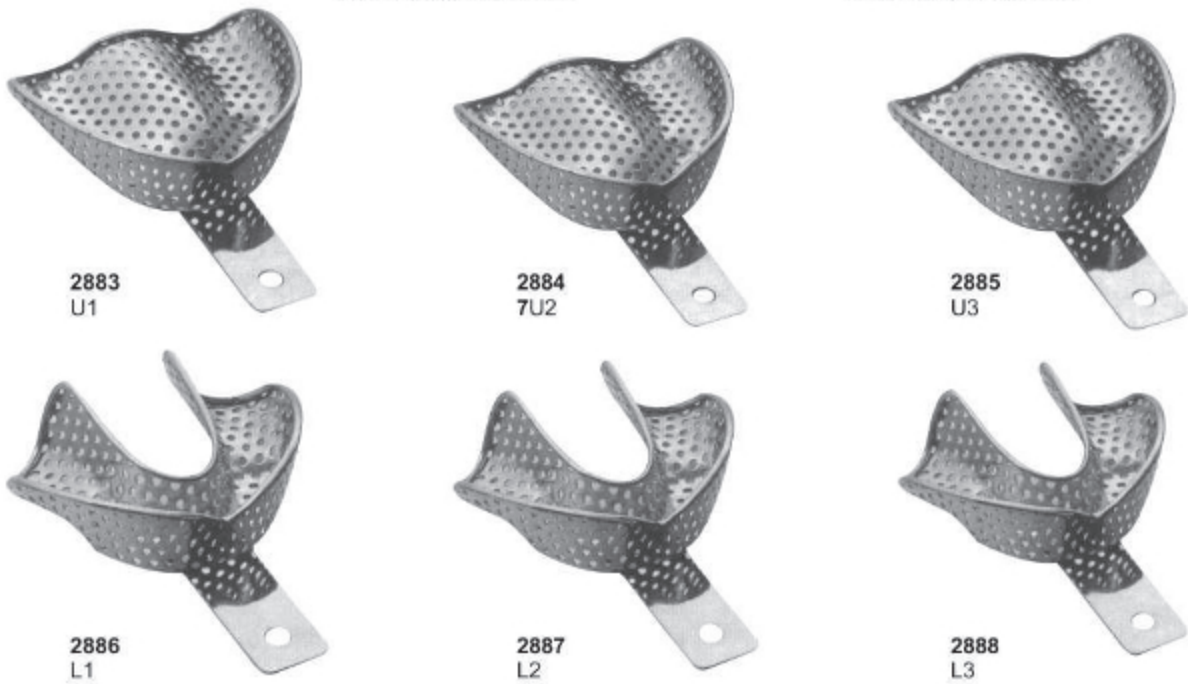

Perforated Set of 6

## Impression Trays

Made of 18/8 Stainless Steel, English Pattern Set of 8



2889  
Lower



2890  
Upper

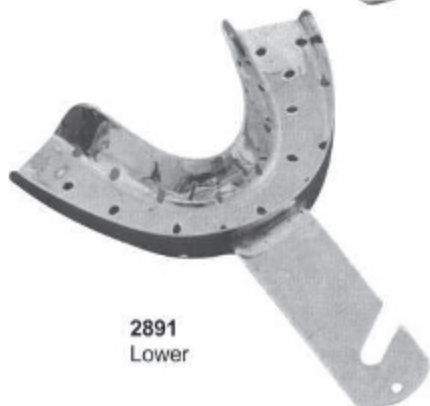

2891  
Lower



2892  
Upper



2893  
Lower



2894  
Upper

All The Above Impression Trays are Available in These 4 Sizes

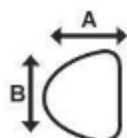

UPPER	Size	A	B	C
	0	67	50	12
	1	72	51	13
	2	78	55	15
	3	80	58	15

All Dimension are in mm

LOWER	Size	A	B	C
	0	70	50	14
	1	77	51	15
	2	79	55	15
	3	80	60	17

All Dimension are in mm

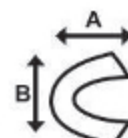



## Impression Trays

Made of 18/8 Stainless Steel, Solid Full Denture Set of 8

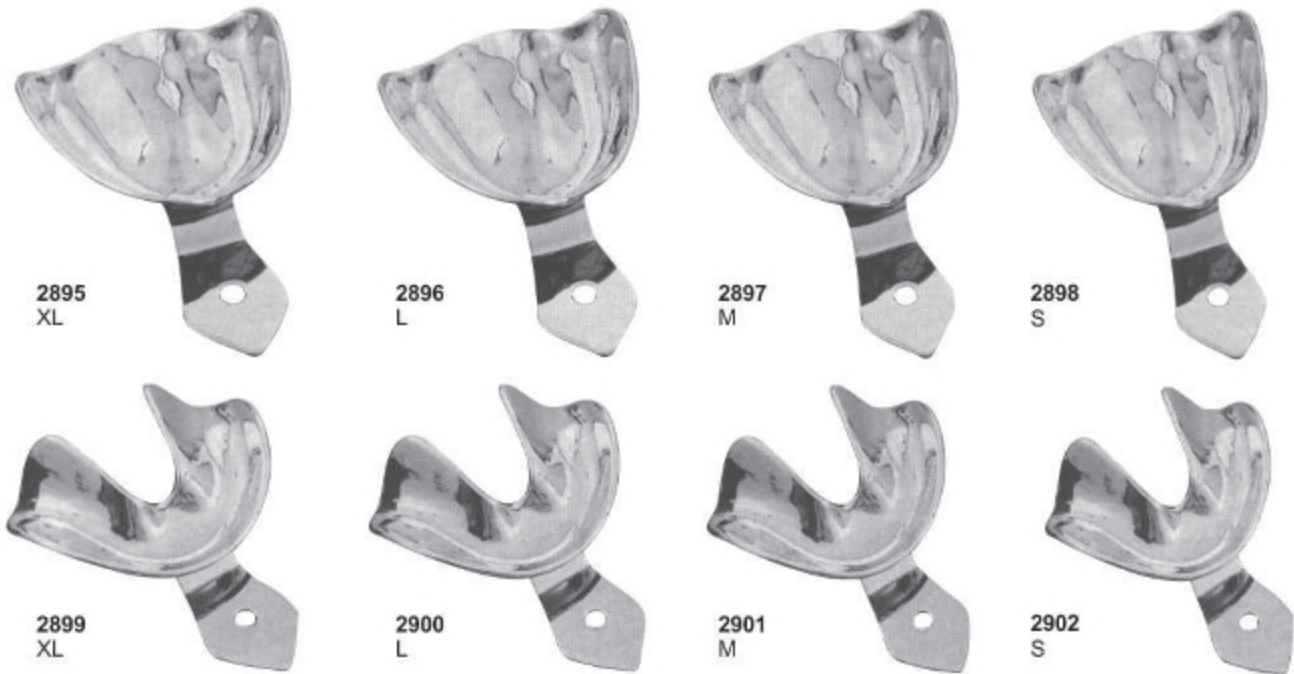

All The Above Impression Trays are Available in These 4 Sizes

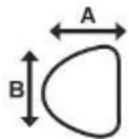

UPPER		XL	L	M	S
	A	70	67	64	60
B	79	76	70	73	

All Dimension are in mm

LOWER		XL	L	M	S
	A	64	64	60	57
B	86	70	73	70	

All Dimension are in mm

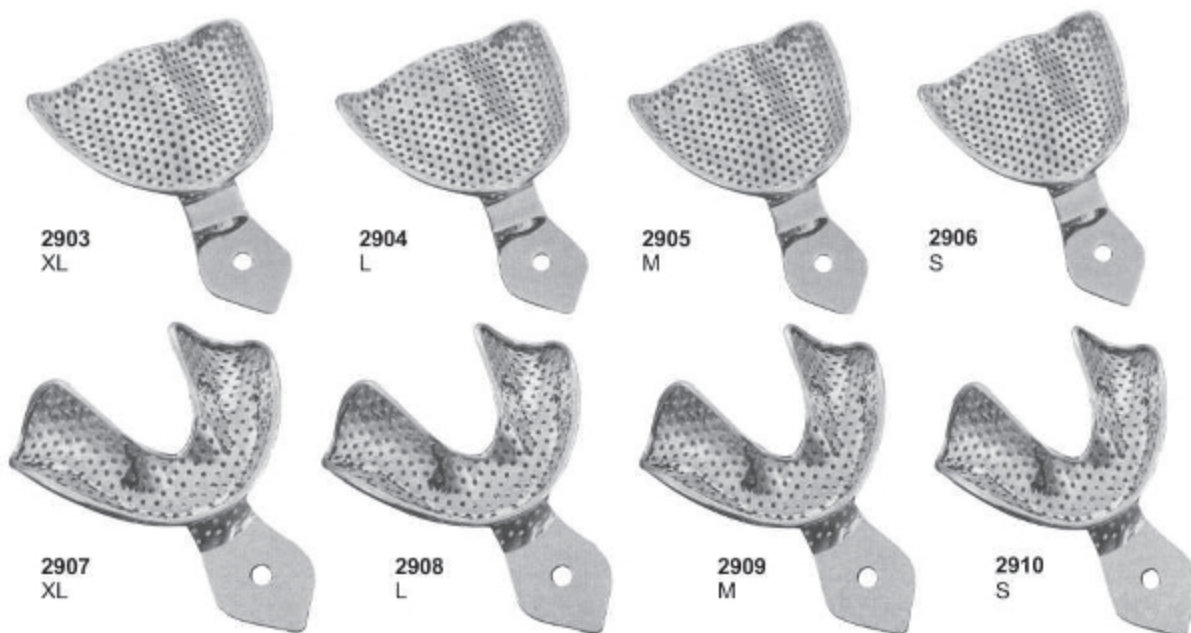

Made of 18/8 Stainless Steel, Perforated Full Denture Set of 8



## Impression Trays

Made of 18/8 Stainless Steel, Solid Full Denture Set of 8

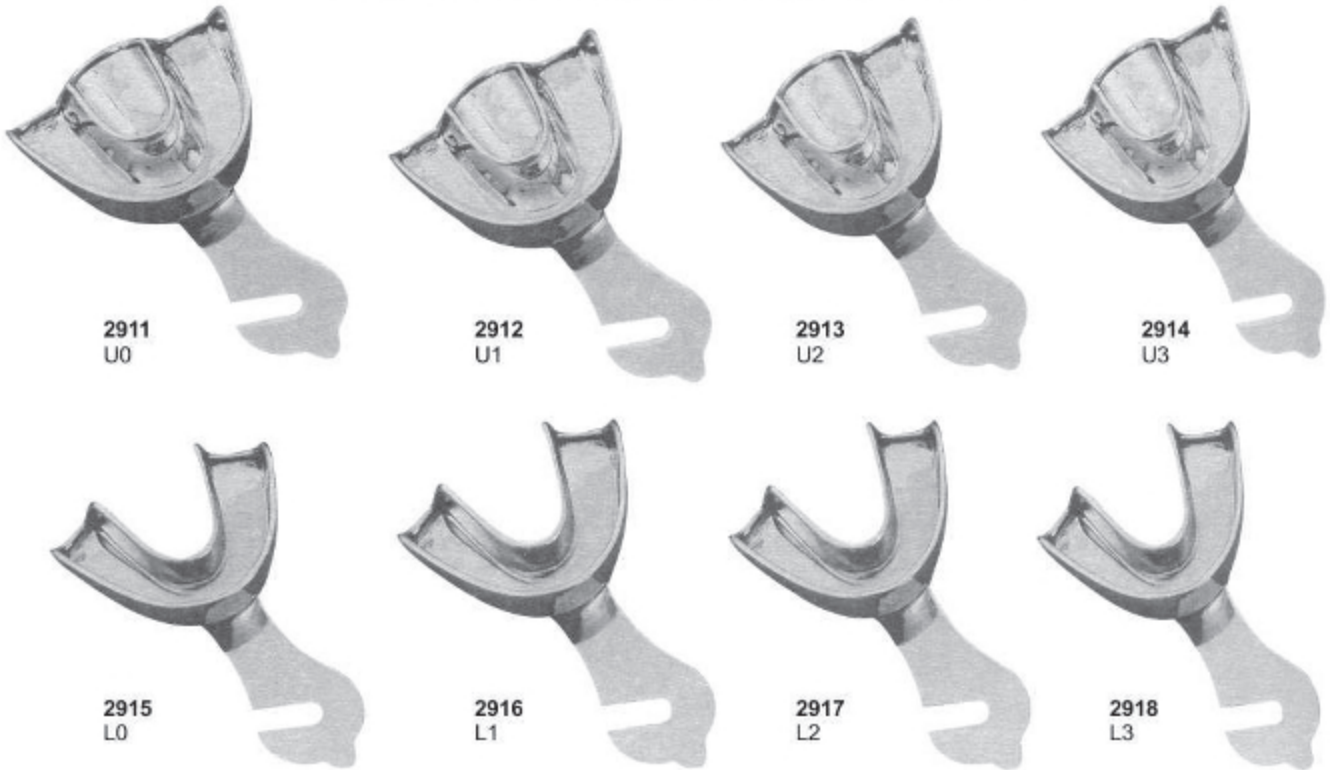

Upper Sizes: 0,1,2,3

Depth of Tray: 15,9 mm, Height of Plate: 12,5 mm

Lower Sizes: 0,1,2,3

Depth of Tray: 12,9 mm

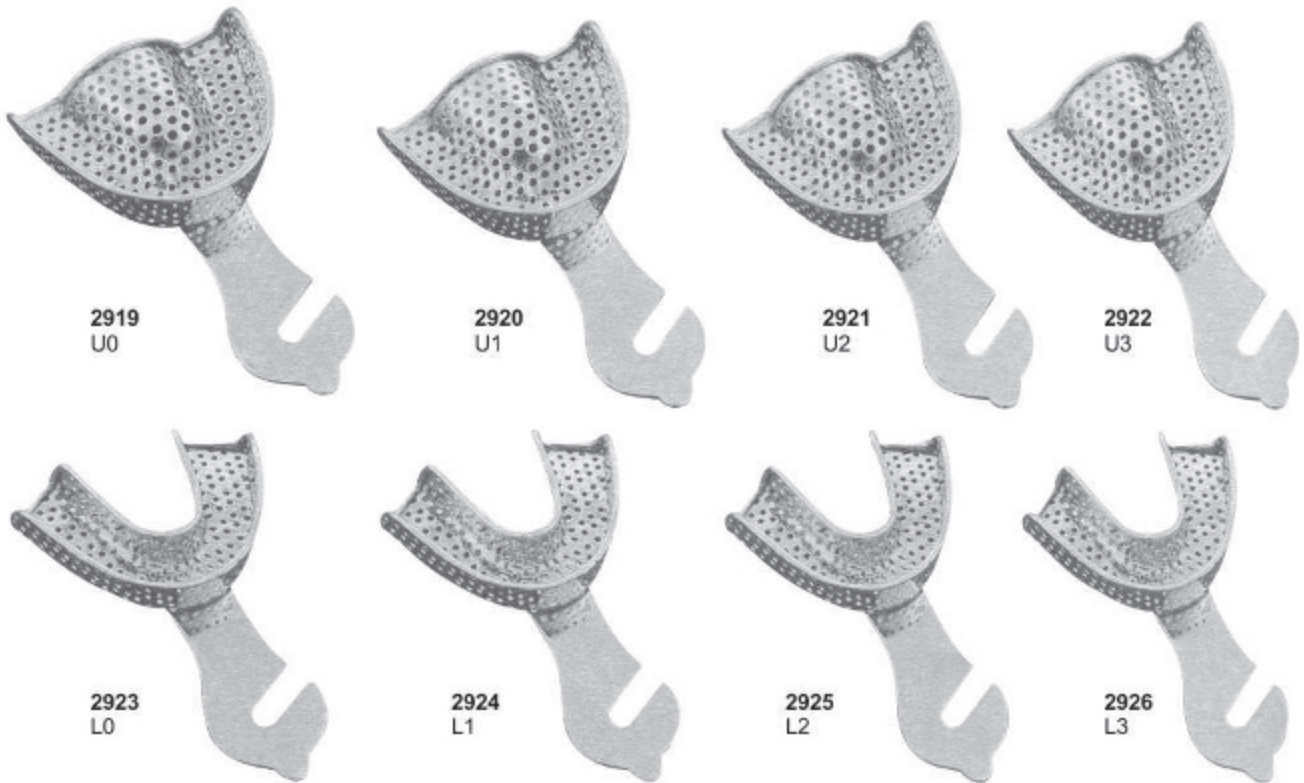

Made of 18/8 Stainless Steel, Perforated Full Denture Set of 8

## Impression Trays

### Impression Trays For Crown & Bridge Work

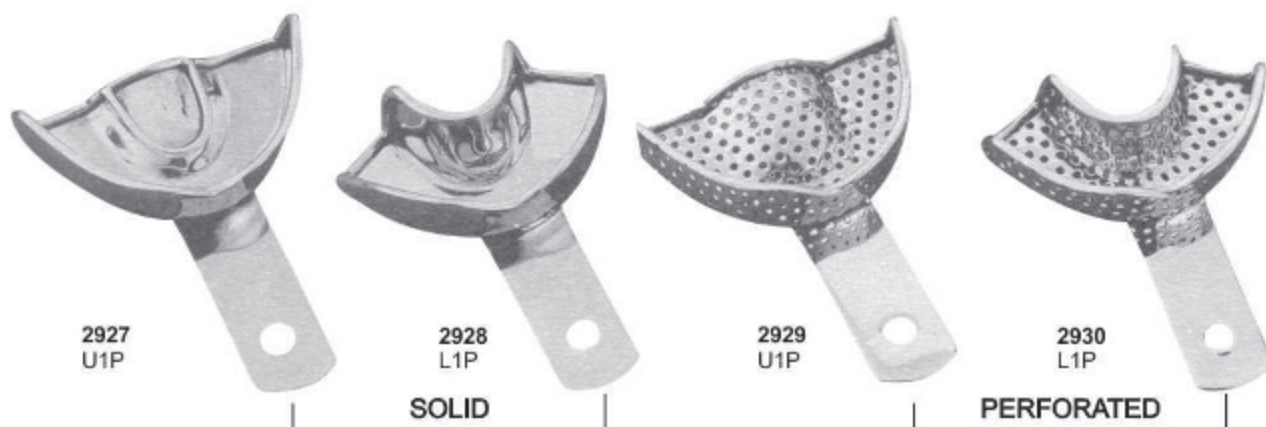

2927  
U1P

2928  
L1P

2929  
U1P

2930  
L1P

SOLID

PERFORATED



2932  
Adjustable  
Perforated



2933  
Adjustable  
Solid

PERFORATED

SOLID



2931-A  
For upper right jaw  
For lower left jaw

2931-B  
For upper left jaw  
For lower right jaw



2931-C  
For upper right jaw  
For lower left jaw

2931-D  
For upper left jaw  
For lower right jaw

**Available in 4 sizes**

- 1.....44 mm
- 2.....55 mm
- 3.....60 mm
- 4.....65 mm

**Available in 4 sizes**

- 1.....44 mm
- 2.....55 mm
- 3.....60 mm
- 4.....65 mm

**Articulators**

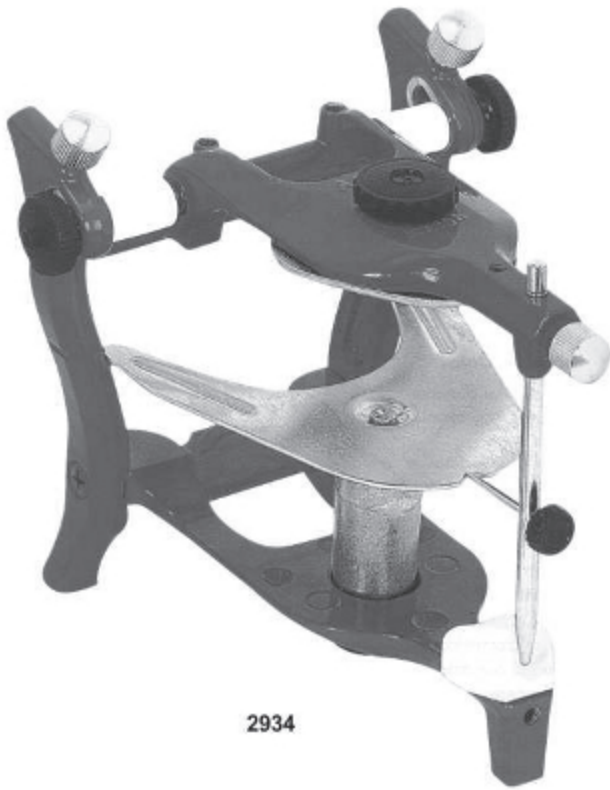

2934



2935



2936



2937



2939



2938



**Articulators**

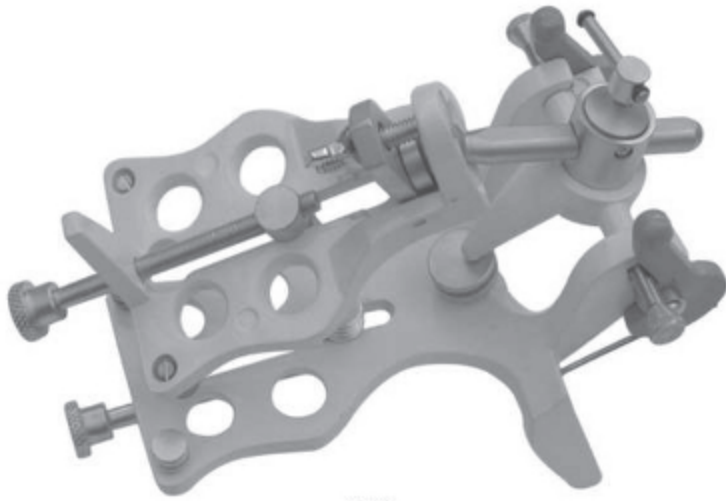

2940



2941



2942



2943

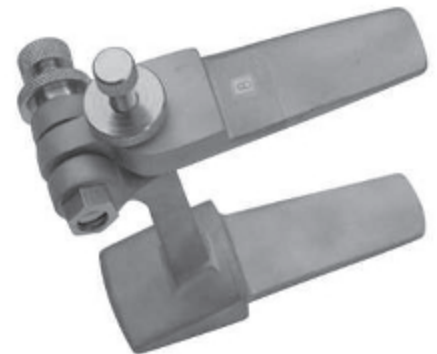

2944



2945



2946



2947



**Hollow Ware**

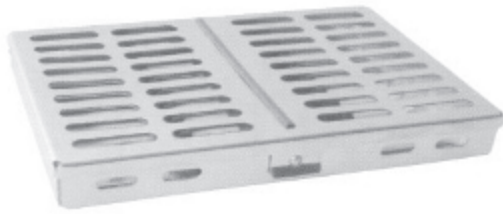

**2948**  
 Instruments Tray of 20 Pcs



**2951**  
 Instruments Riddle



**2949**  
 Instruments Tray of 7 Pcs



**2949-A**  
 Instruments Tray of 10 Pcs



**2950**  
 Instruments Tray of 5 Pcs

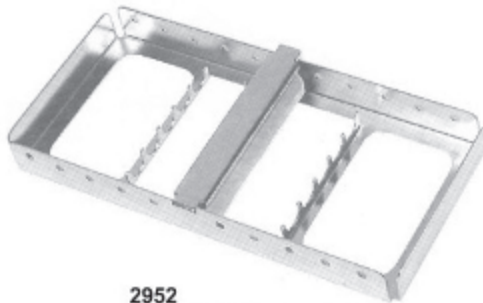

**2952**  
 Instruments Tray of 5 Pcs

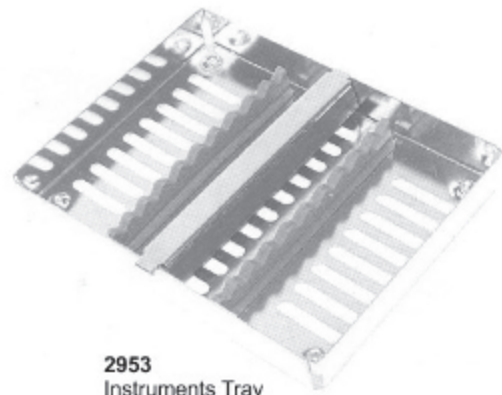

**2953**  
 Instruments Tray



**2954**  
 Instruments Tray  
 Perforated



**2955**  
 Instruments Tray  
 Perforated Base



**2956**  
 Instruments Tray  
 Solid Base

**Hollow Ware**



**2957**  
 Pulpectomy Tray



**2958**  
 Sterilizing Box  
 Available Sizes:  
 17x17x3 cm  
 20x10x6 cm  
 30x14x6 cm



**2959**  
 Endo Tray Box



**2960**  
 Finger Cup



**2961**  
 Bur Box

**2962**  
 Sterilizing Drum  
 150x150mm  
 175x175mm  
 190x190mm  
 200x140mm  
 200x200mm  
 240x120mm  
 225x225mm  
 240x240mm  
 290x160mm



**2963**  
 Sterilizing Drum  
 280x240mm  
 230x150mm  
 300x250mm  
 340x160mm  
 350x250mm  
 390x200mm  
 380x300mm  
 100x100mm  
 150x120mm

## Sterilizing Boxes & Instruments Trays



**2964**  
Instruments Box



**2965**  
Instruments Box



**2966**  
Instruments Box



**2967**  
Instruments Sterilizer  
150x75 mm



**2968**  
Endodontic Box



**2969**  
Sterilizing Box  
320x120 mm



**2970**  
Instruments Tray



**2971**  
Instruments Tray



**2972**  
Instruments Tray  
(Perforated)



**2973**  
Instruments Tray  
Shallow(Mayo)



**2974**  
Scaler Tray  
20.0 x 10.0 x 1.5 cm

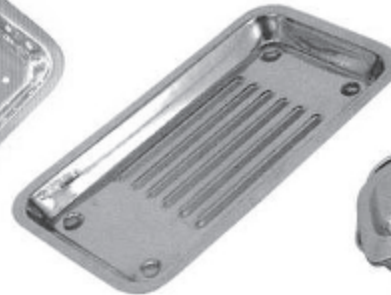

**2975**  
Scalers Tray



**2976**  
Scalers Tray



**Hollow Ware**





**Hollow Ware**



**2989**  
Sponge Bowl



**2990**  
Wash Basin  
300mm-350mm-400mm



**2994**  
Kick Bucket With Trolley



**2991**  
Sponge Bowl



**2992**  
Gallipot



**2993**  
Medicine Cup



**2995**  
Kidney Tray Shallow  
150mm-200mm-240mm-300mm



**2996**  
Kidney Tray Without Lid  
150mm-200mm-250mm-300mm



**2997**  
Kidney Tray With Lid  
150mm-200mm-250mm-300mm

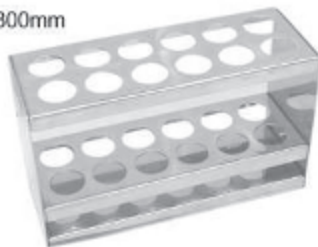

**2998**  
Tube Rack, Stainless Steel 18/10



**2999**  
Needle Case Rectangle  
Needle Case Round With Cover  
90x15



**3000**  
Dustbin Without Stand  
6-10-12 Ltr



**3001**  
Tube Rack, Round Model  
Stainless Steel 18/10



**3002**  
Dustbin Without Stand & Cap  
6-10-12 Ltr



**3003**  
Lotion Bowl With Lip  
40-60-80-100-120-150-180-200mm

**Scissors with Tungsten Carbide Inserts**



**3004**  
Standard



14,5cm  
16,5cm  
18,5cm



**3005**  
Standard



14,5cm  
16,5cm  
18,5cm



**3006**  
Standard



14,5cm  
16,5cm  
18,5cm



**3007**  
Standard



14,5cm  
16,5cm  
18,5cm



**3008**  
Standard

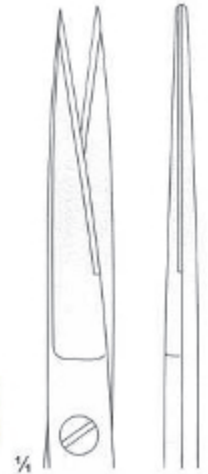

14,5cm  
16,5cm  
18,5cm



**3009**  
Standard



14,5cm  
16,5cm  
18,5cm

**Scissors with Tungsten Carbide Inserts**

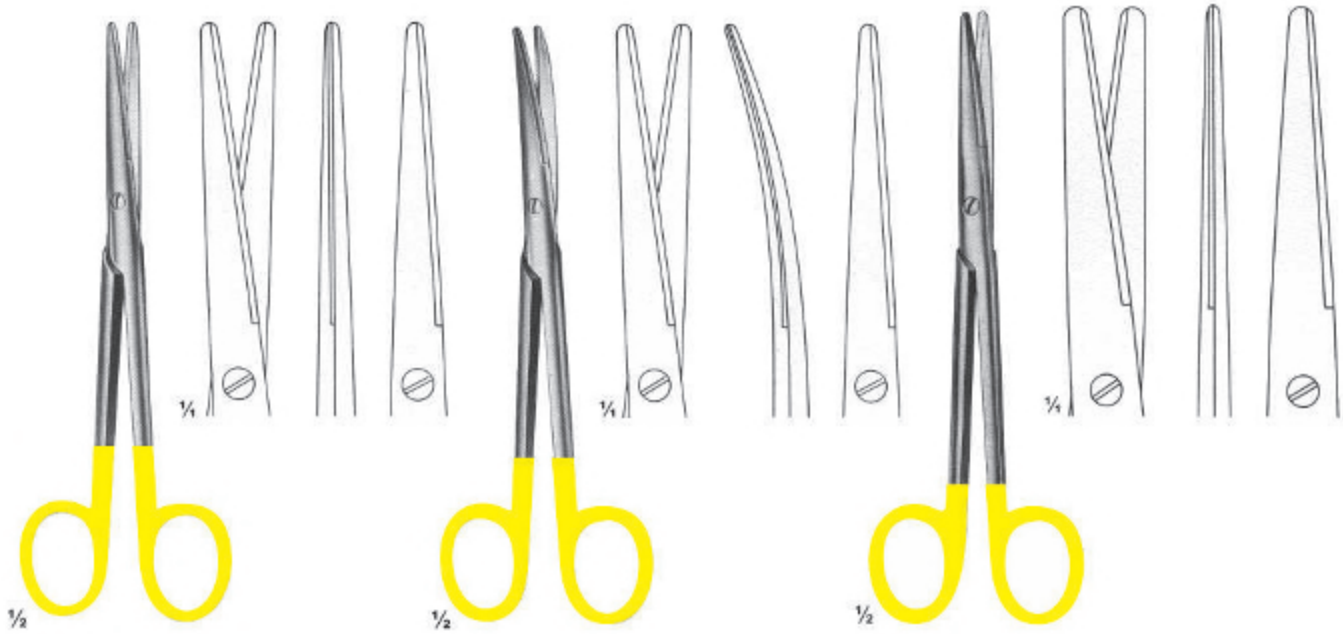

**3010**  
 MAYO-LEXER  
 Straight  
 16 cm

**3011**  
 MAYO-LEXER  
 Curved  
 16 cm

**3012**  
 LEXER  
 Straight  
 16, 21 cm

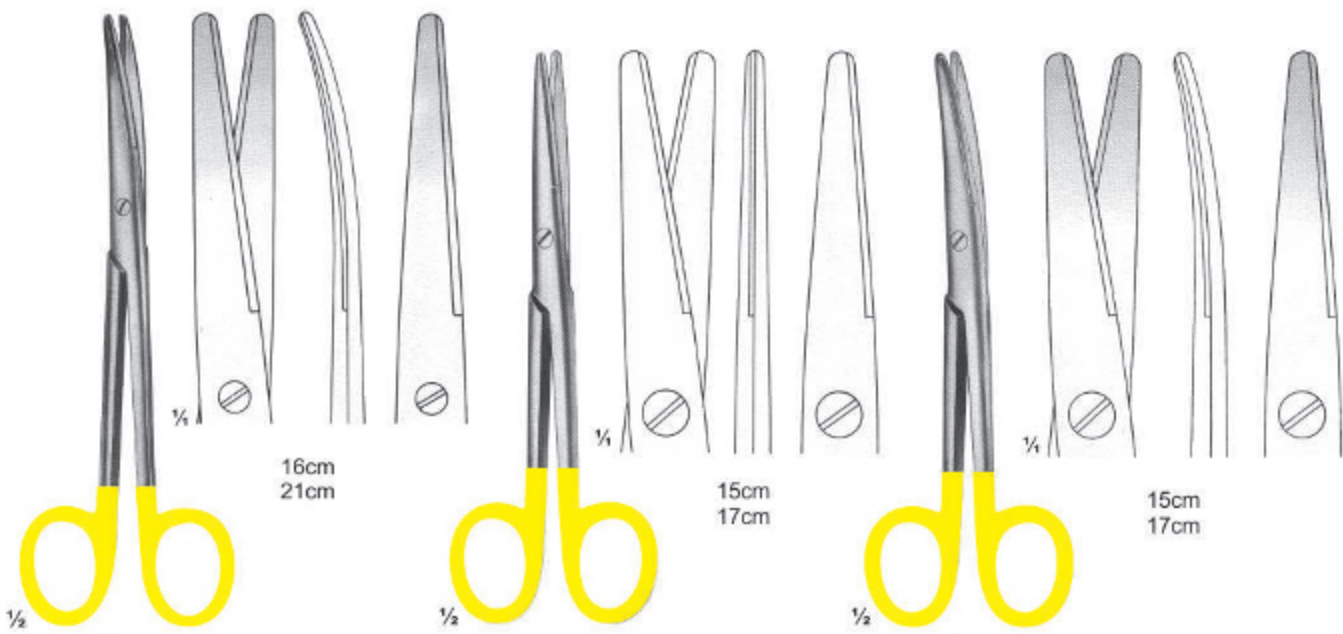

**3013**  
 LEXER  
 Curved  
 16, 21 cm

**3014**  
 MAYO-STILLE  
 Straight  
 15,17 cm

**3015**  
 MAYO-STILLE  
 Curved  
 15,17 cm



**Scissors with Tungsten Carbide Inserts**

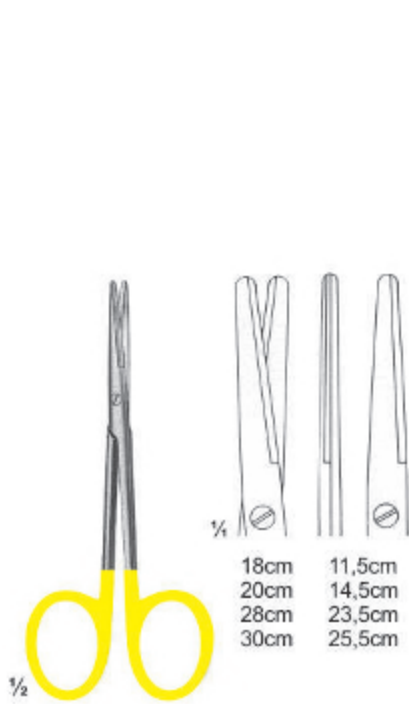

**3016**  
**METZENBAUM**  
 Straight



**3017**  
**METZENBAUM**  
 Curved

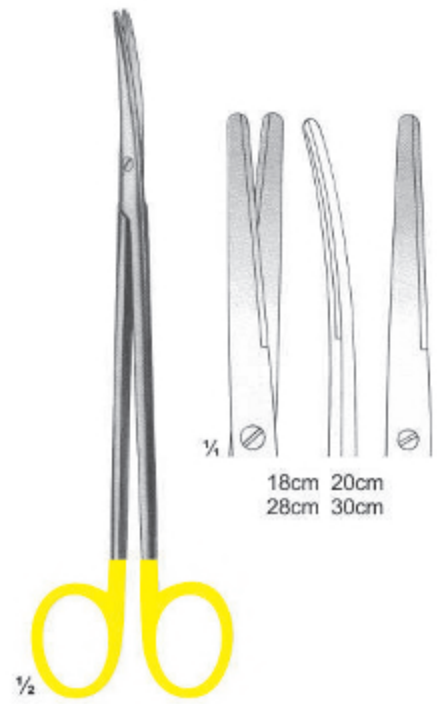

**3018**  
**METZENBAUM**  
 Curved



**3019**  
**METZENBAUM FINO**  
 Straight



**3020**  
**METZENBAUM FINO**  
 Curved

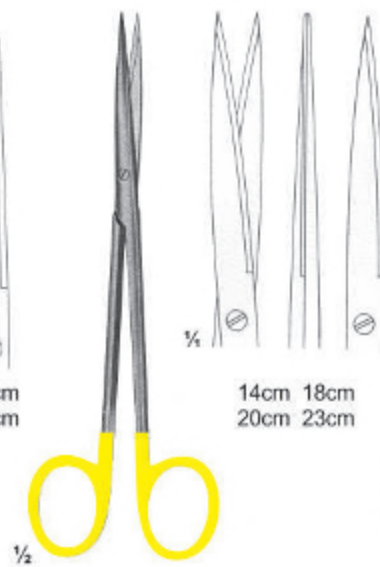

**3021**  
**METZENBAUM FINO**  
 Sharp

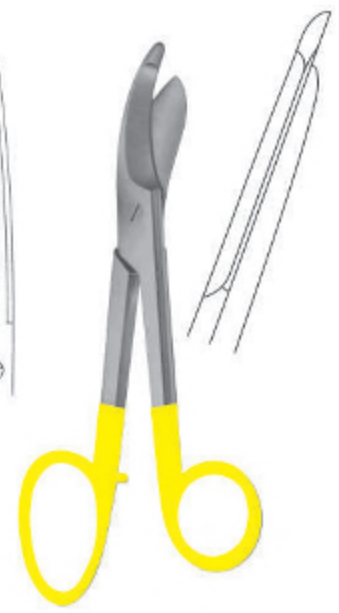

**3022**  
**BRUNS**  
 235 mm



**Scissors with Tungsten Carbide Inserts**

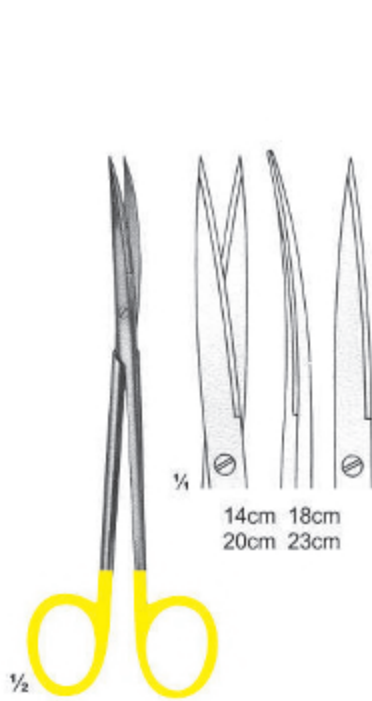

**3023**  
 METZENBAUM FINO

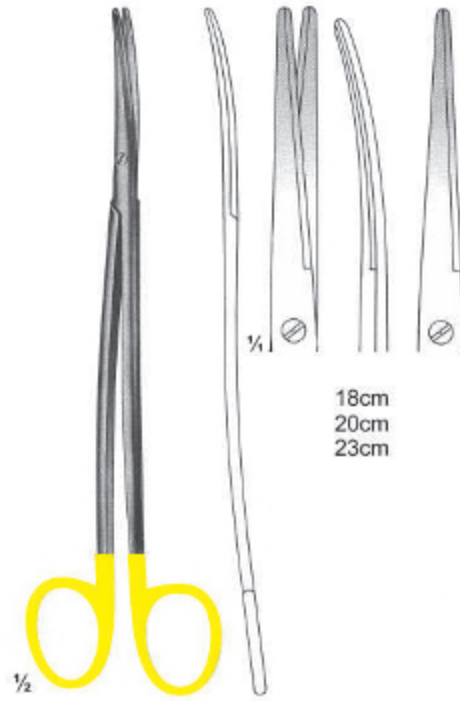

**3024**  
 METZENBAUM FINO

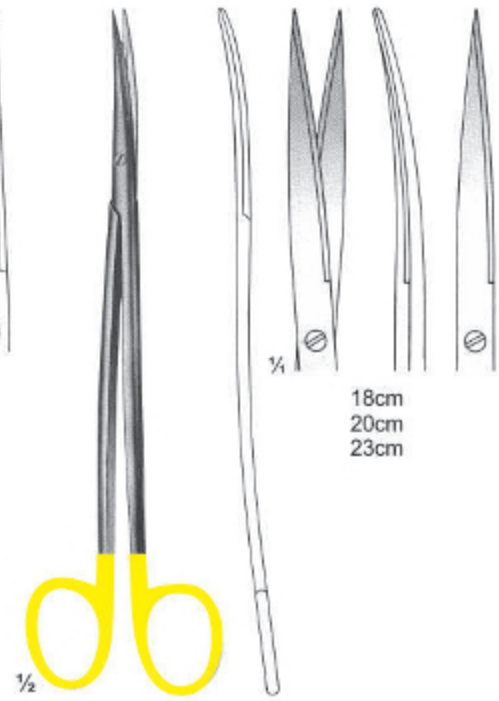

**3025**  
 METZENBAUM FINO

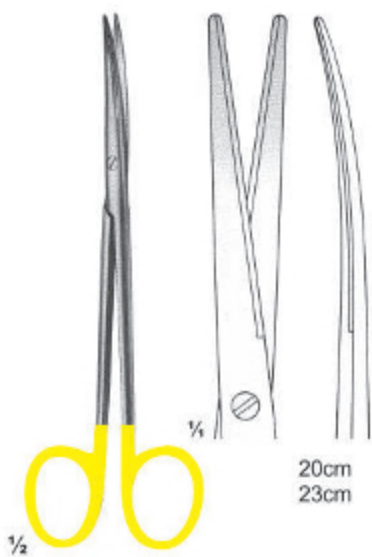

**3026**  
 METZENBAUM FINO

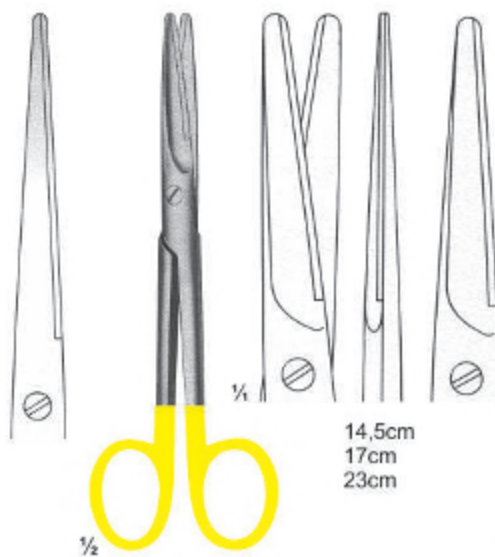

**3027**  
 MAYO  
 Straight

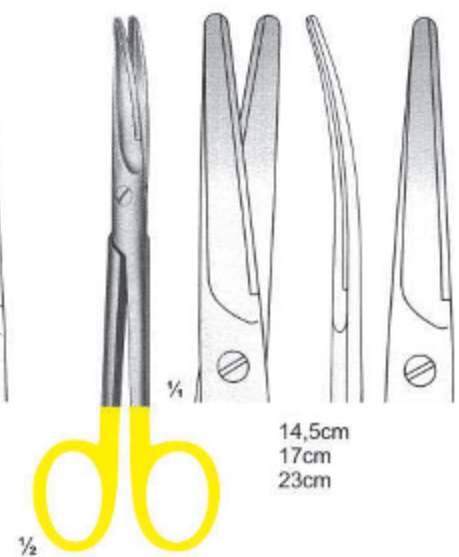

**3028**  
 MAYO  
 Curved

**Scissors with Tungsten Carbide Inserts**

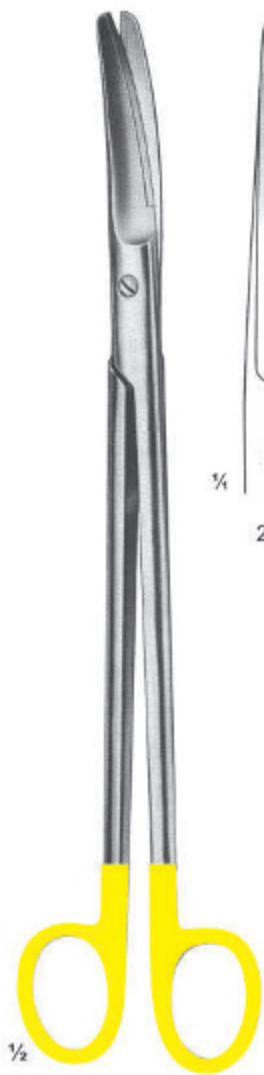

**3029  
SIMS**



23cm

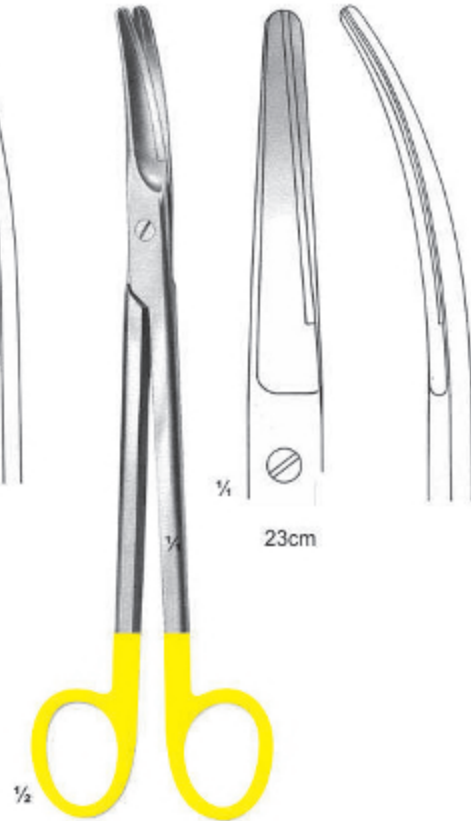

**3030  
PARAMETRIUM**



23cm

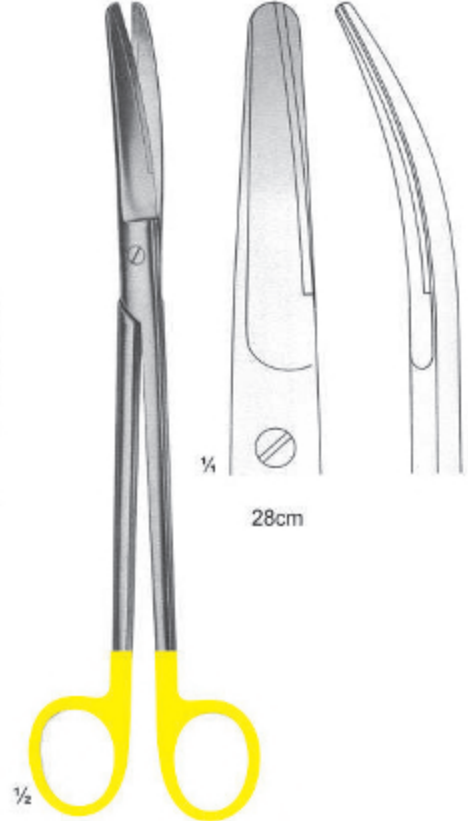

**3031  
MAYO-HARRINGTON**



28cm



**3032  
KELLY  
Straight 16 cm**



**3033  
KELLY  
Curved 16 cm**



**3034  
DEAN  
17 cm**



**3035  
LAGRANGE  
Double-Curved  
11.5 cm**

**Scissors with Tungsten Carbide Inserts**

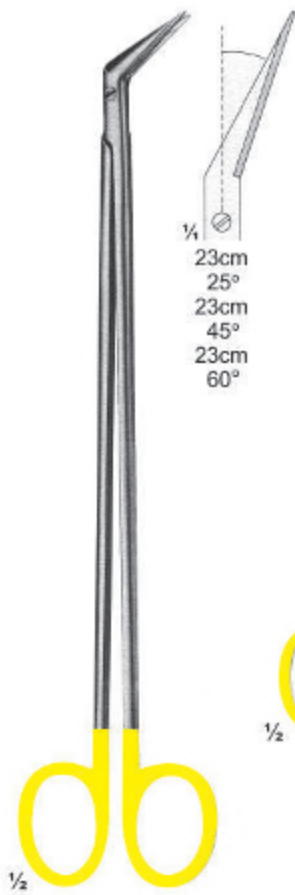

**3036**  
DE-BAKEY



**3037**  
DE-BAKEY

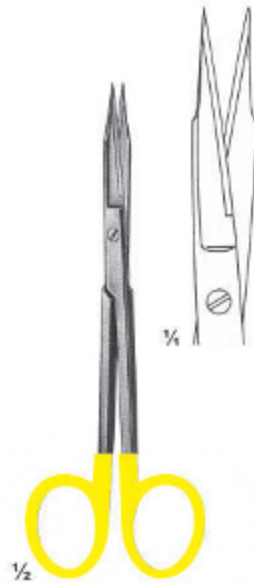

**3038**  
GOLDMAN FOX  
13 cm



**3039**  
GOLDMAN FOX  
Double-Curved  
13 cm



**3040**  
GOLDMAN FOX  
13 cm

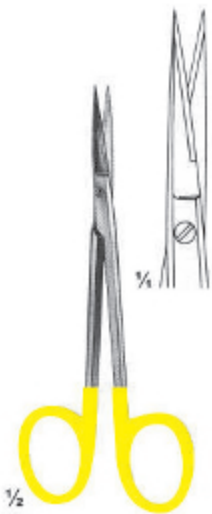

**3041**  
Fine Scissors  
Straight  
11, 5 cm

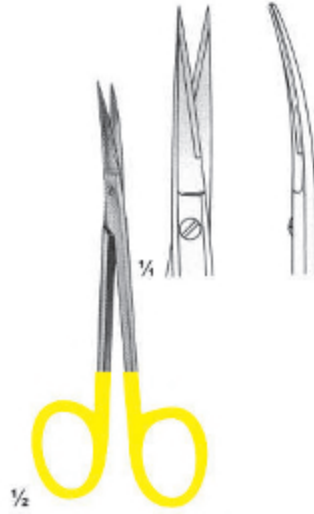

**3042**  
Fine Scissors  
Curved  
11, 5 cm



**3043**  
Fine Scissors  
Angled  
11, 5 cm



**3044**  
RAGNELL  
Curved  
12 cm

**Scissors & Dissecting Forceps with T.C. Inserts**



**3045**  
UNIVERSAL  
12cm



**3046**  
Ligature Scissors  
1 Black & 1 Goldplated ring



**3047**  
MERIAM  
16 cm



**3048**  
ADSON



**3049**  
ADSON



**3050**  
CUSHING  
17,5 cm

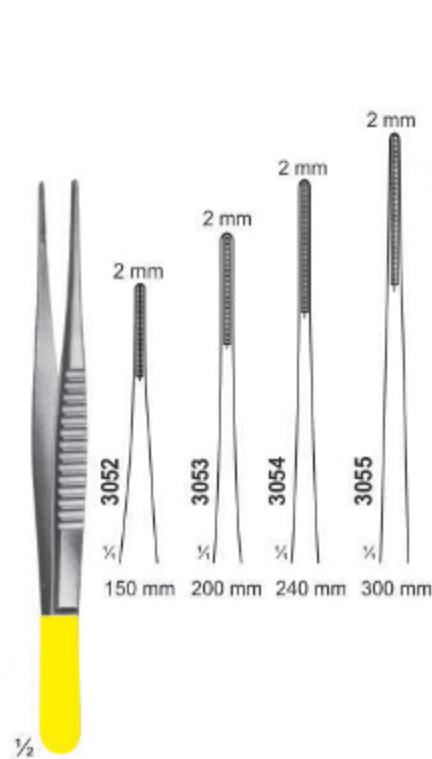

**3051**  
DE BAKEY  
17,5 cm



**3056**  
CASTROVIEJO  
Curved  
15 cm



**3057**  
CUSHING  
18 cm



**3058**  
CUSHING-  
TAYLOR  
18 cm



**3059**  
Dressing  
Forceps  
15 cm



**3060**  
SEMKEN  
15 cm



**3061**



**Dissecting & Needle Holders T.C. Instruments**

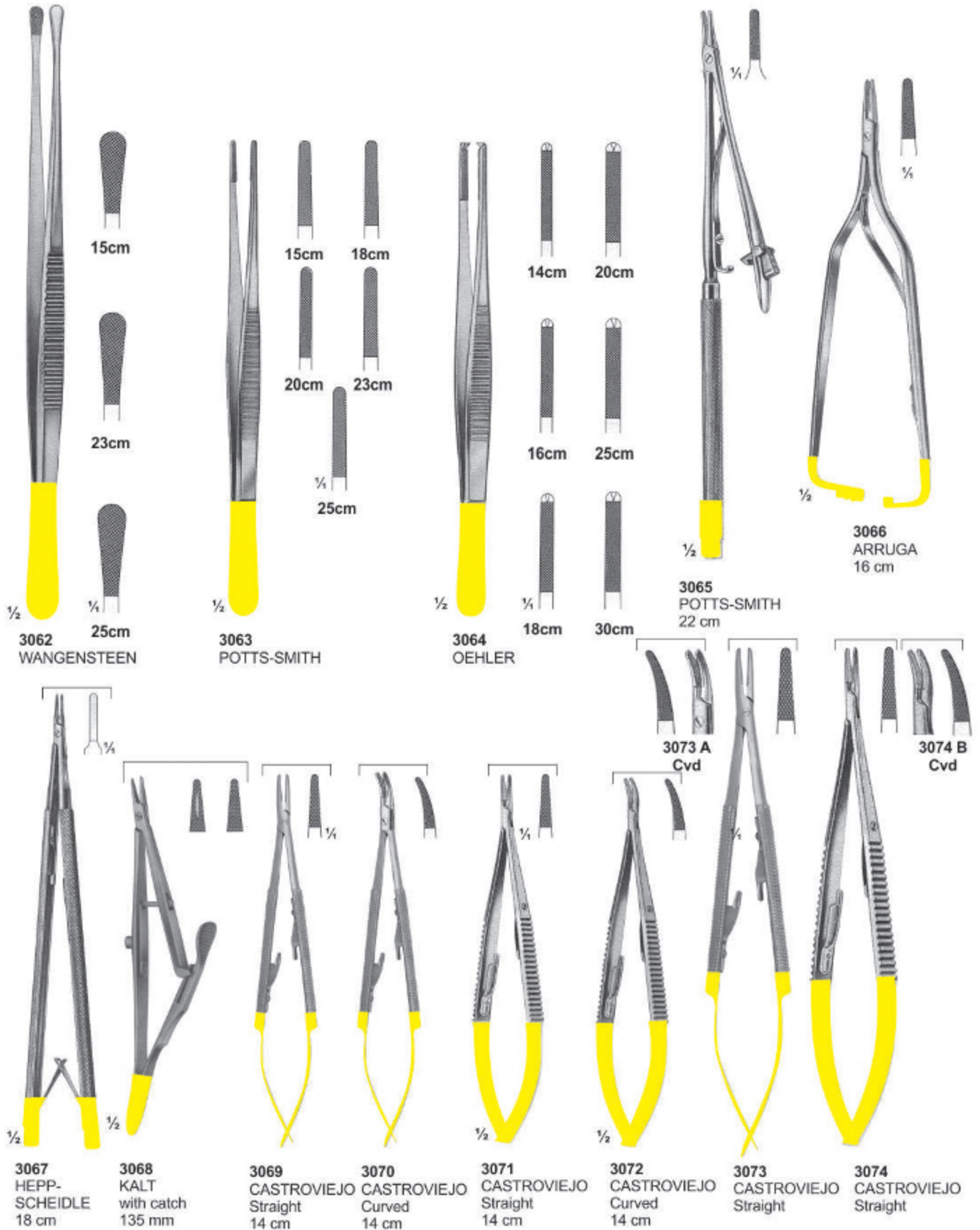

## Needle Holders with T.C. Inserts

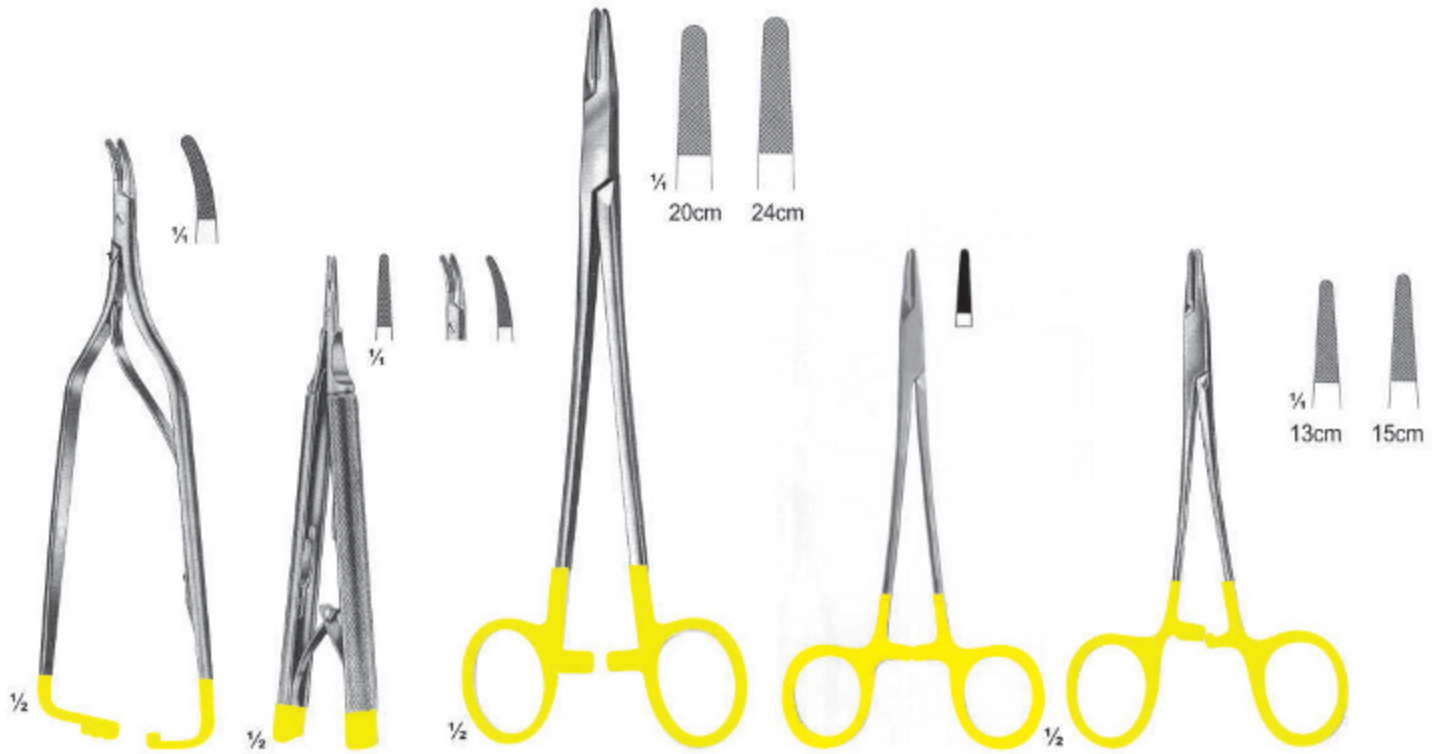

**3075**  
ARRUGA  
Curved  
16 cm

**3076**  
CASTROVIEJO  
13 cm

**3077**  
HEGAR  
20,24 cm

**3078**  
SMOOTH TIP  
15 cm

**3079**  
HALSEY  
13,15 cm

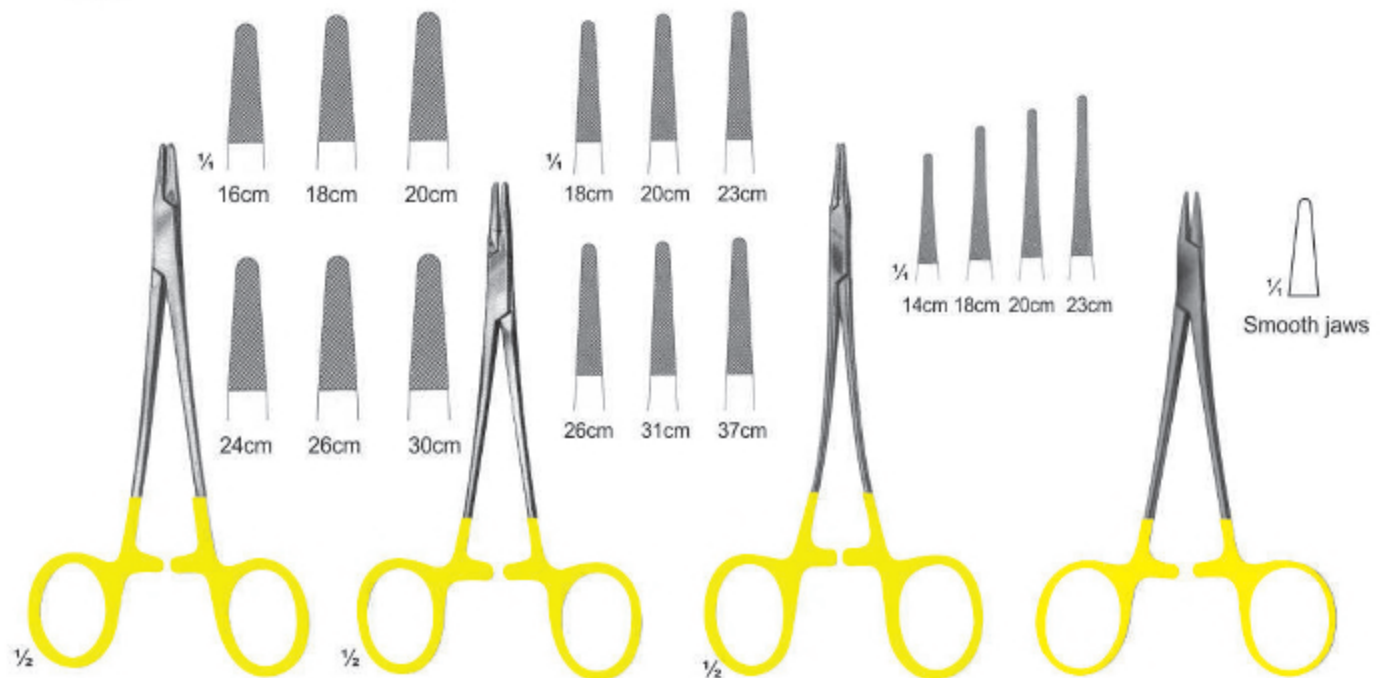

**3080**  
MAYO-HEGAR

**3081**  
DE BAKEY

**3082**  
HEGAR-VASCULAR

**3083**  
WEBSTER  
125 mm

**Needle Holders with Tungsten Inserts**

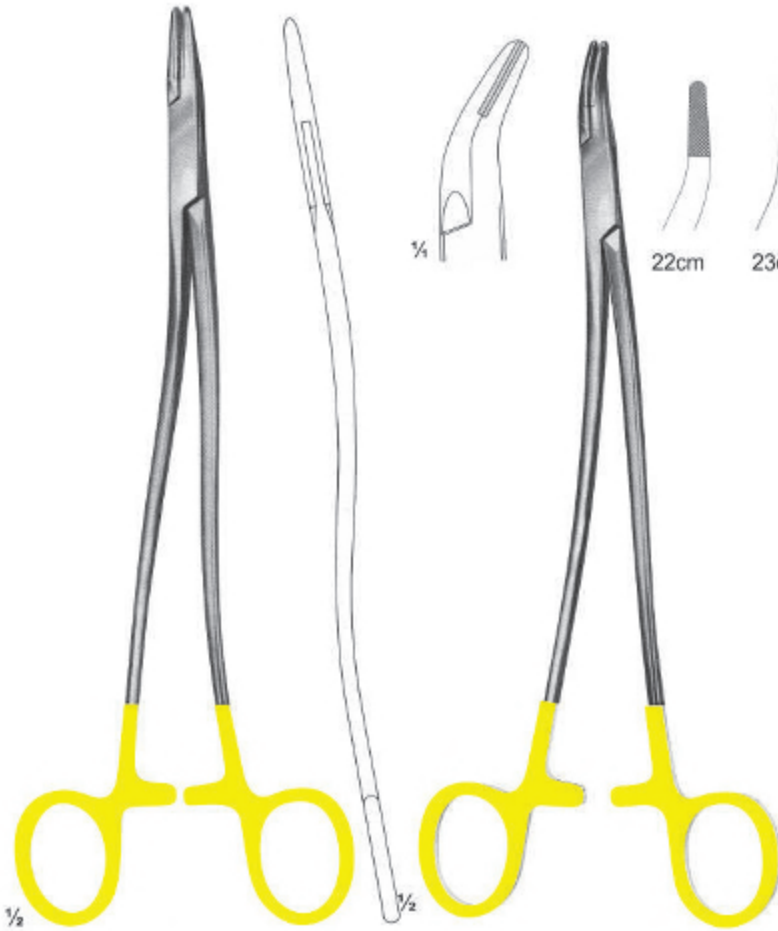

**3084**  
 BOZEMANN-WERTHEIM  
 20, 24, 26 cm

**3085**  
 STRATTE

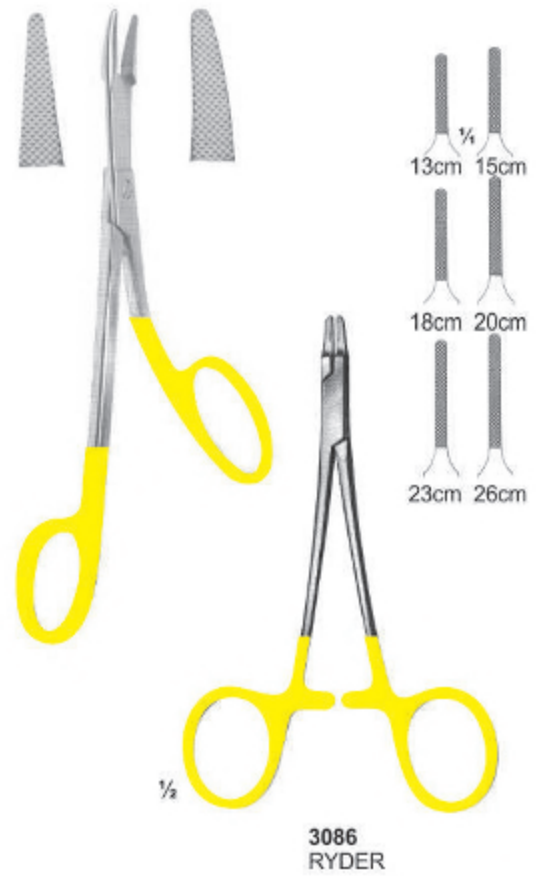

**3086**  
 RYDER



**3087**  
 RYDER-VASCULAR

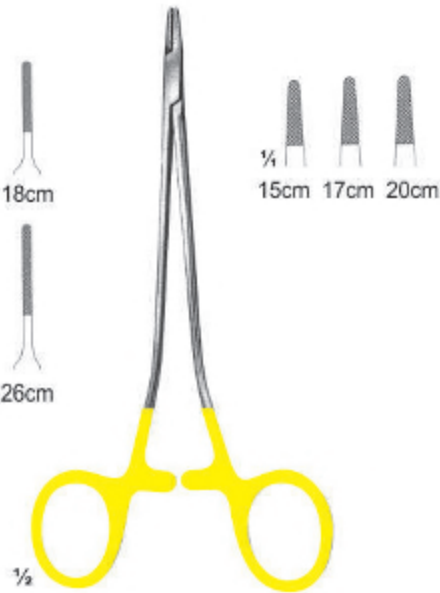

**3088**  
 MARTIN

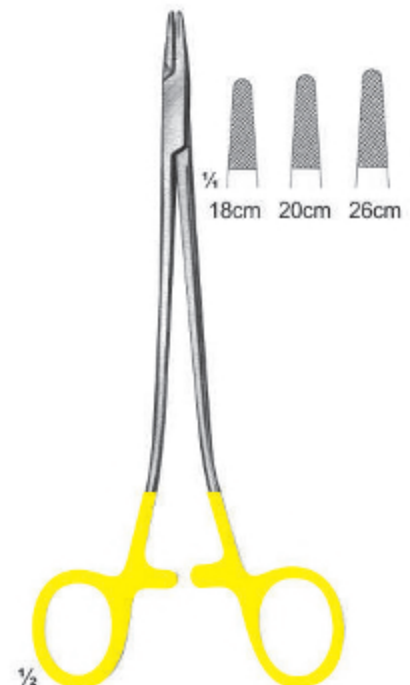

**3089**  
 SAROT



## Needle Holders with Tungsten Inserts

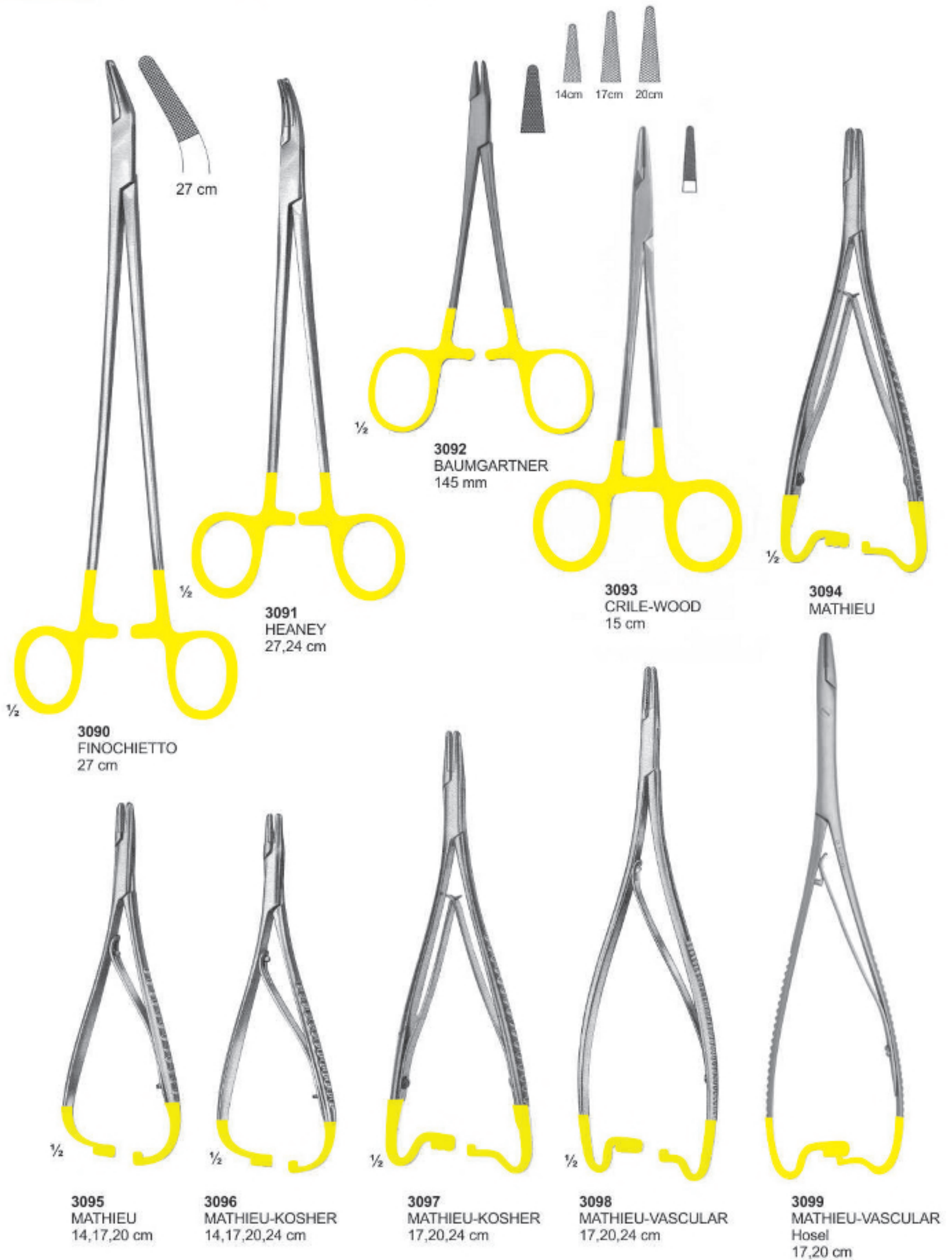



**Needle Holders with T.C. Inserts**



**3100**  
 MATHIEU-RYDER  
 17,20,24 cm

**3101**  
 Hosel  
 Curved  
 20 cm

**3102**  
 LICHTENBERG  
 20 cm

**3103**  
 LANGHALS  
 20,25 cm

**3104**  
 LICHTENBERG  
 20,25 cm

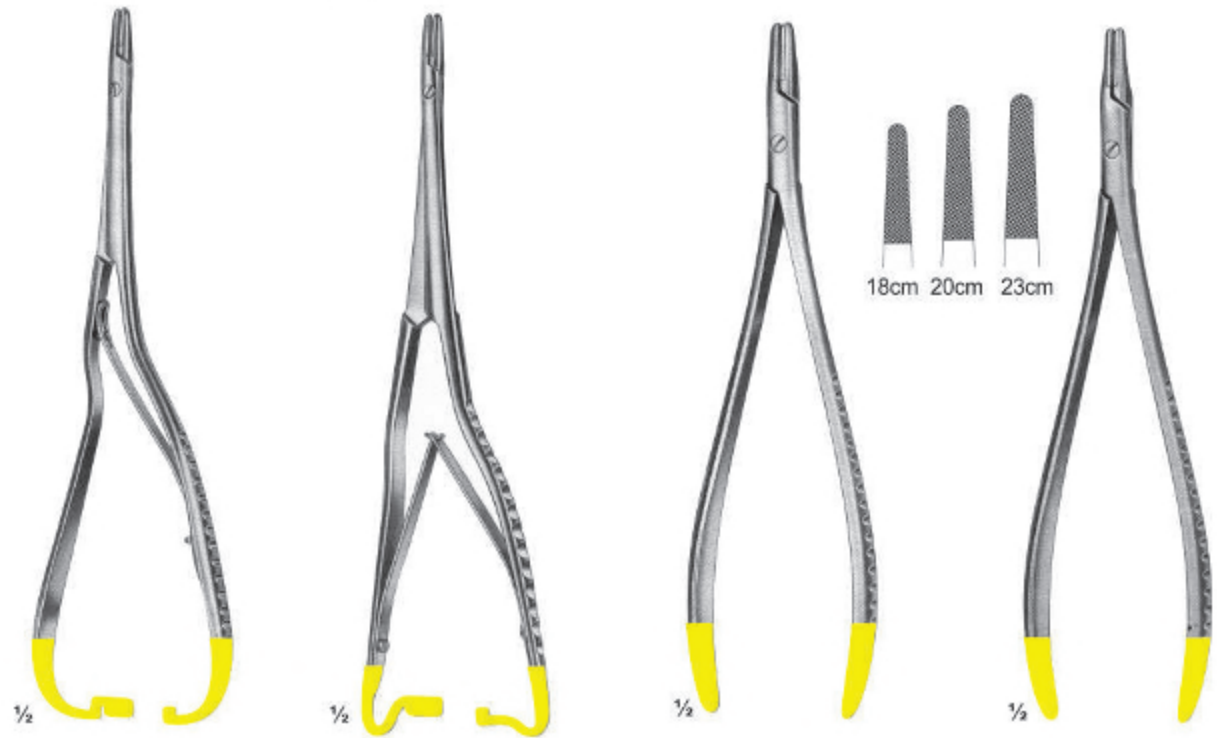

**3105**  
 LUEHTY-BECK  
 20,25 cm

**3106**  
 LUEHTY-BECK  
 20,25 cm

**3107**  
 LANGENBECK  
 18,20,23 cm

**3108**  
 LANGENBECK  
 18,20,23 cm

**Wire Cutting Plier with T.C. Inserts**



**3109**  
**TOENNIS**  
 Elastic pattern for  
 dura-or intestinal suture  
 180 mm



**3110**  
**Cutting Plier**  
 12 cm

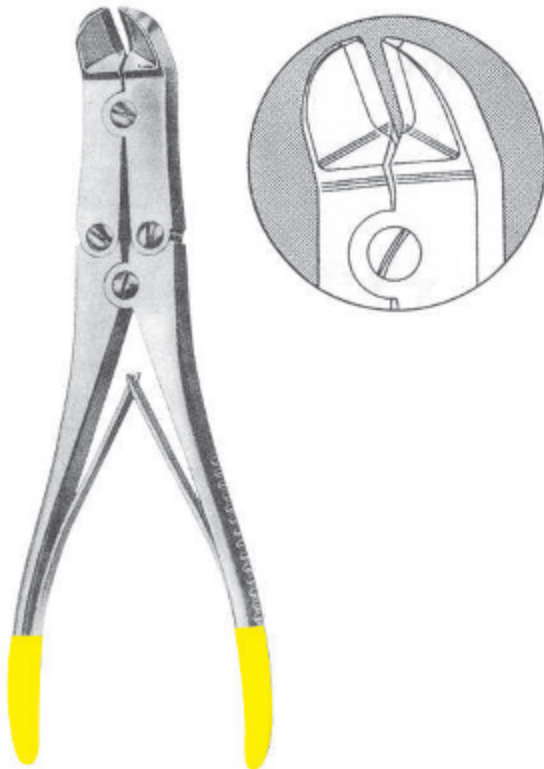

**3111**  
**MULLAR CLAUS**  
 22 cm



**3112**  
**Plier**  
 17.5 cm

## Alphabetical Index

<b>A</b>			
Adams, Pliers	174	Bone Gauge,	144
Aderer, Pliers	174	Bone Mill Forcep,	139
Adson, Forceps	158,207	Bone Pluggers,	140
Adson, Tweezers	151	Bracket, Gauge	144
Ainsworth, Rubber Dam Punch	147	Buser, Elevator	52
Albee	143		
Albrecht, Tweezers	155	<b>C</b>	
Allen, Tweezers	155	Carvers	102,103
Allis, Tissue Forceps	158	Castroviejo, Needle Holder	181,208,209
Amalgam Applicators	97	Castroviejo, scissors	186
Amalgam Condensers	97	Castroviejo, Gauge	144
Amalgam Pluggers	97	Castroviejo, Sclerer Marker	144
Amalgam Carriers	145	Cement Instruments	118,119,121
Amalgam Guns	145	Cement Spatulas	120,122
Andresen, Pliers	175	Chisels	103
Andrews, Tongue Depressor	160	Chompret, Elevator	63
Angle, Pliers	169,174	Cleveland, Rongeurs	177,178
Apical, Elevator	57,63	College, Tweezers	152,154
Arruga, T.C. Needle Holder	208,209	Collier, Needle Holder	180
Articulators	194-195	Collin, Retractor	162
Aspirating Syringes	149	Columbia, Curettes	110,111,116
Allen 9A, Elevator	50	Composite Placement	104,105
		Con Scodellino, Wax Knives	126
		Cord Packers	95
		Cottle, Scissors	184
		Coupland, Elevator	58
		Crane-Kaplan	128
		Crile, Forceps	157
		Crile, Needle Holder	181
		Crile-Wood, Needle Holder	180
		Crown Instruments	135,136
		Crown Removers	134,135
		Crown Shell, Pliers	166
		Cryer, Elevator	55,58,69
		Cushing , T.C. Forceps	207
		Cushing, Tweezers	151
		Cushing-Taylor , T.C. Forceps	207
		<b>D</b>	
		De Bakey , T.C. Forceps	207
		De Bakey, Scissors	184,186,206
		De Bakey, T.C. Needle Holder	209
		De La Rosa, Pliers	169
		Deaver, Scissors	184
		Denhart, Mouth Gag	160
		Derf, Needle Holder	180
		Disposable Products	117
		Dr.Sader, Elevator	69
		Dressing Forceps	207
		Dean Scissors	186,205
<b>B</b>			
Baby-Allis, Tissue Forceps	158		
Band Removing Pliers	170		
Bane, Rongeurs	179		
Barnhart, Curettes	110,116		
Barry, Elevator	66,69		
Baum Gartner, Needle Holder	180,211		
Bee Be, Scissors	186		
Bein, Elevator	54,61		
Beyer, Rongeurs	179		
Bird Beak Pliers	167		
Blumenthan, Rongeurs	176		
Boley Gauge	143		
Bone Curettes	129		
Boynton, Needle Holder	181		
Bozemann-Wertheim, T.C. Needle Holder	210		
Bracket, Pliers	170		
Brewer, Rubber Dam Instruments	147		
Brown, Tissue Forceps	158		
Brown-Adson, Tissue Forceps	158		
Bruns, T.C. Scissors	203		
Buchs, Retractor	162		
Burnishers	99-100		
Ball Chain	146		
Boley Gauge,	143		



# Alphabetical Index

<b>E</b>			
Elevators	51	Hatchets	95
Endodontic Condensers	86,87	Heaney, T.C. Needle Holder	211
Ernert, Wax Knives	126	Hegar, T.C. Needle Holder	209
Excavators	89-91	Hegar-Vascular, T.C. Needle Holder	209
Explorers	80-82,91-94	Heidbrink, Elevator	64,67,69
Extraction forceps (American Pattern)	36-49	Heidbrink, Elevator	57
Extraction forceps (English Pattern)	1-24	Howard 9H, Elevator	52
Extraction forceps (fitting handle)	25-33	Height Gauge,	143
Extraction forceps (For Children)	34	Hepp-Scheidle, T.C. Needle Holder	208
		Hlasted-Mosquito, Forceps	159
		Hoes	95,125
		Hollow Ware	196-200
		How, Pliers	167,174
		Howard, Bone Files	131
		Hylin, Elevator	61
<b>F</b>			
Fahnenstock, Wax Knives	126		
Files	125	<b>I</b>	
Filling Instruments	106,107	Implant Instruments	137-141
Fine, T.C. Scissors	206	Impression Trays	187-193
Finochietto, T.C. Needle Holder	211	Iris Scissors	183
Finochietto, T.C. Needle Holder	211	Ivory, Rubber Dam Instruments	147
Fischer, Pliers	175		
Flagg, Tweezers	154	<b>J</b>	
Flohr, Elevator	56	Jarabak, Pliers	165
Fomon, Tissue Retractor	164	Jeseph, Scissors	183
Freer, Elevator	52	Johnson, Pliers	169,175
Friedman, Rongeurs	178	Joseph, Tissue Retractor	164
Furrer, Pliers	174		
Film Hanger	146	<b>K</b>	
Finger Cup	197	Kalt, T.C. Needle Holder	208
Flohr, Elevator	57	Kelly, Forceps	159
Freer	15,16,	Kelly, Scissors	183
Elevator	52	Kelly Scissors	205
		Kim's Plier	165
		Kirkland, knife	114
<b>G</b>		Knives	125
Gardner, Bone Chisels	132	Knowles, Scissors	184
Gardner, Needle Holder	180	Kocher, Retractor	162
Gardner, Rongeurs	178	Kocher-Langenbeck, Retractor	162
Gillies, Hook	164	Kopp, Elevator	60,68
Gillies, Tweezers	151	Kopp , Tweezers	151
Goldman Fox , T.C. Scissors	206		
Goldman Fox, Curettes	112,113	<b>L</b>	
Goldman Fox 14, Elevator	50	Lab & Office Pliers	166
Goldman Fox, knives	114	Landgraf, Tweezers	154
Goslee, Pliers	175	Langenbeck, Pliers	175
Gracey Curettes	108,109,116	Langenbeck, Retractor	162
<b>H</b>			
Halsey, T.C. Needle Holder	209		
Handles	72		
Hartman, Rongeurs	179		



## Alphabetical Index

Langenbeck, T.C. Needle Holder	212	Mini-Blumenthan, Rongeurs	176
Langer, Curettes	110,116	Molt, Elevator	50
Langhals, T.C. Needle Holder	212	Molt, Mouth Gag	160
Lecluse, Elevator	65	Molt 9, Elevator	50
Lessmann, Wax Knives	126	Morrison, Elevator	56
Lexer, T.C. Scissors	202	Mouth Mirrors with Handles	73
Lichtenberg, T.C. Needle Holder	212	MSY, Pliers	175
Ligature, T.C. Scissors	207	Mullar Claus, Wire Cutting Pliers T.C.	213
Lip & Cheek Retractors	161,162		
Lister, Scissors	184	<b>N</b>	
Littauer, Scissors	186	Nance, Pliers	168,169,174
Littler, Scissors	184	Napkin Holders	146
Locklin, Scissors	186	Neivert, Needle Holder	180
London Hospital, Elevator	62	Nelson-Metzenbaum, Scissors	185
London-College, Tweezers	154,155	Non Chill	146
Lucae, T.C. Forceps			
Luehty-Beck, T.C. Needle Holder	212	<b>O</b>	
Lwanson, Crown Gauge	143	O'Brien, Pliers	168
Lagrange, Scissors	186,205	Obturation Instruments	88
Littaure, Scissors	186	Ochsenbein	128
Lwanson, Crown Gauge	143	Ordan, knife	114
		Oehler, T.C. Forceps	208
<b>M</b>		Olsen-Hegar, Needle Holder	180
Martin, T.C. Needle Holder	210	Optical Pliers	168
Mathieu, Needle Holder	181,211	Orthodontic Cutters, T.C.	172
Mathieu-Kosher, T.C. Needle Holder	211	Orthodontic Distal & Cutters	173
Mathieu-Ryder, T.C. Needle Holder	212	Orthodontic Pliers, T.C.	171
Mathieu-Vascular, T.C. Needle Holder	211	Ott, Elevator	62
Mayo Harrington, T.C. Scissors	205		
Mayo, Scissors	185,204	<b>P</b>	
Mayo-Hegar, Needle Holder	181	Parametrium, T.C. Scissors	205
Mayo-Hegar, T.C. Needle Holder	209	Partsch, Bone Chisels	133
Mayo-Lexer, T.C. Scissors	202	Partsch, Bone Mallet	133
Mayo-Stille, T.C. Scissors	202	Pean, Forceps	157
Mayo-Stille Scissors	185	Peeso, Pliers	166,175
Mc Kellops, Pliers	175	Peets, Forceps	157
Mccalls, Curettes	110,111,116	Perry, Tweezers	151
Mcindoe, Tweezers	151	P.K. Thomas,	96
Mead, Bone Mallets	133	Pich,	98
Mead, Elevator	64	Pluggers,	98
Mead, Rongeurs	179	Prichard, Elevator	50
Meriam, T.C. Forceps	207	Plastic Handle Elevators	70
Meriam, Tweezers	153,155	Polokoff, Bone File	131
Metzenbaum Fino, T.C. Scissors	203,204	Pott, Elevator	51
Metzenbaum, Scissors	185,203	Potts-Smith, T.C. Forceps	208
Micro Surgery Set	182	Potts-Smith, T.C. Needle Holder	208
Micro-Adson, Tweezers	151	Probes	82-85,91,94
Micro-Friedman, Rongeurs	178		
Middledorpf Retractor	162	<b>Q</b>	
Miller, Articulating Forceps	147	Quinby, Scissors	183
Miller, Bone Files	130		

## Alphabetical Index

### R

Ragnell , T.C. Scissors	206
Retainers, Bands	146
Reynolds, Pliers	169,174
Root Planning Curettes	115
Root splinter forceps	35
Roux, Retractor	162
Rubber Dam Clamps	148
Rubber Dam Holder	147
Rule, Curette	110
Russian, Tissue Forceps	158
Ryder, T.C. Needle Holder	210
Ryder-Vascular, T.C. Needle Holder	210

### S

Sarot, T.C. Needle Holder	210
Scalers	75-79
Scalpel Handles	71
Schwarz, Pliers	168,175
Schluger, File	114
Seldin, Elevator	50,55,67
Select, Tweezers	151
Semken, T.C. Forceps	207
Semkin, Tissue Forceps	158
Senn, Tissue Retractor	164
Separating Pliers	166
Sims, T.C. Scissors	205
Spatulas	123
Spencer, Scissors	186
Spencer-Wells, Forceps	157
Spreaders	87
Split Chisels,	128
Spring Bow Divider	143
Standard, T.C. Scissors	201
Standard, Tweezers	151
Steiner, Pliers	166
Sterilizing & Lab Instruments	156
Sterilizing Forceps,	163
Stevens, Needle Holder	181
Stevens, Scissors	183
Stille, Scissors	185
Stratte, T.C. Needle Holder	210
Strip Holder Clips	146
Syringes	150
Suction Tubes,	140,142
Sugarman, File	114

### T

Toennis, Wire Cutting Pliers T.C.	213
-----------------------------------	-----

Toennis-Adson, Scissors	184
Toennis, Tissue Retractor	164
Towel Clamps, Napkin Holders	159
Tweed, Pliers	168
Telescope, Crown Plier	136
Traymann, Crown Remover	128

### U

Universal , T.C. Scissors	207
Universal, Pliers	174
Universal, Elevator	135
Utility Plier	165

### V

Vernier, Measuring Instruments	143
Vernier Gauge	143

### W

Wakefield, Bone Chisels	132
Waldron, Pliers	174
Waldsachs, Pliers	174
Wangensteen, T.C. Forceps	208
Warwick-James, Elevator	62
Waugh, Tweezers	151
Wax & Modeling Carvers	120
Wax & Plaster Knives	127
Wax Carvers	101
Wax, Porcelain Instruments	118,119,121
Webster, Needle Holder	180,209
Weingart , Utility Pliers	167
Weitlaner, Retractor	160
West, Elevator	50
White, Rubber Dam Instrument	147
Wieder, Tongue Depressor	160
Winter, Elevator	65,69
Wire & Clasp Bending Pliers	170
Wire Bending Pliers	166
West, Elevator	50
Wire Cutter	165
Woodson,	98

### Y

Young, Pliers	168,174
---------------	---------

### Z

Zuricher, Measuring Instrument	143
Zuricher, Gauge	143

# DENTAL INSTRUMENTS CATALOGUE



P.O. BOX 1365,  
Daska Road Addah,  
Sialkot - 51310, Punjab PAKISTAN

Ph: +92-52-6526511  
Fax: +92-52-6526992

E-mail: [info@seasoned.pk](mailto:info@seasoned.pk)  
[seasoned@brain.net.pk](mailto:seasoned@brain.net.pk)  
URL: <http://www.seasoned.pk>

[www.seasoned.pk](http://www.seasoned.pk)